

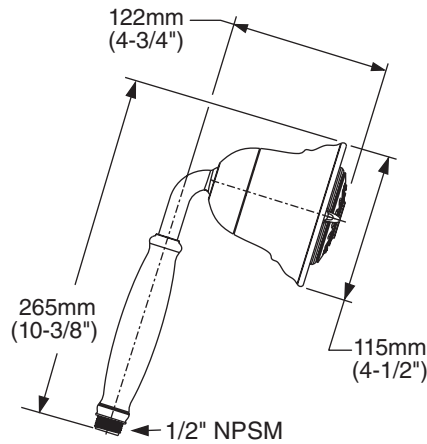

MODEL NUMBER:

- ☐ 1660.143 FloWise® Traditional 3-Function Water Saving Hand Shower



GENERAL DESCRIPTION:

Hand shower adjusts from an Ultra Water Saving Turbine Spray at 1.5gpm to a Combination spray at 2.0gpm to a Full spray at 2.0gpm. Hand shower uses 40% less water when in Ultra Water Saving mode and 20% when in Combination or Full spray modes. Hand shower rated at 2.0gpm/7.6L/min. maximum flow rate. Auto Return feature always returns hand shower to 1.5gpm Ultra Water Saving mode when water is turned off. Includes check valve.

PRODUCT FEATURES:

- Water Saving:** Saves up to 40% in water usage.
- Auto Return:** Hand shower always starts in ultra water savings mode for maximum water savings of 40%.
- Pressure Compensating Flow Control Device:** Provides consistent flow over a wide pressure range.
- Variety of Spray Patterns:** Allows the user to select the type of spray best suited to their needs.
- Easy Clean Spray Nozzles:** Easily clean lime and calcium build up. Nozzles will not clog.

SUGGESTED SPECIFICATION

Hand shower shall save up to 40% in water usage. Hand shower shall always start at 1.5gpm/5.7L/min. and have multiple functions for user's personal selection. Hand shower shall have a permanent built-in pressure compensating control device and shall include a check valve. Fitting shall be American Standard Model # 1660.143.____.



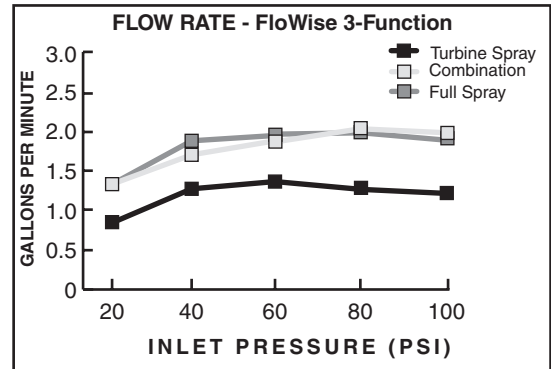

CODES AND STANDARDS

These products meet or exceed the following codes and standards:

ASME A112.18.1
CSA 125.1

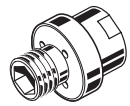

Product Number	Description	Finish Options		
		Polished Chrome	Oil Rubbed Bronze	PVD Satin Nickel
1660.143	FloWise® Traditional 3-Function Water Saving Hand Shower	002	224	295

Hand Shower Accessories	
Product Number	Description
8888.035	59" Metal Shower Hose 
8888.053	79" Metal Shower Hose (Chrome Only) 
1660.400	Vacuum Breaker 
1660.410	Shower Arm Diverter 
8888.096	Shower Arm Bracket 

Hand Shower Accessories	
Product Number	Description
8888.036	Fixed Wall Bracket 
8888.037	Wall Supply 
8888.038	Wall Supply Bracket 