

MECHANICAL FAUCETS

SH-PB1-04-100

Tub and Showers

Product Type

Wall Mounted Pressure Balancing Pressure Balancing Tub and Shower Valve with Shower Head and Diverter Tub Spout

Features & Specifications

- Pressure Balancing
- Pressure Balancing Tub and Shower Valve Only
- 5-3/8" Tub Spout with Diverter
- 2.0 GPM MAX Flow Rate @ 80 PSI Wall Mounted Institutional Shower Head
- Pressure Balance Control Cartridge
- 1/2" Nominal Copper and 1/2" NPT Hot and Cold Supply Inlets and Outlets
- Includes Showerhead Arm and Wall Flange
- Shower Valve Cycles from Cold to Hot
- Embossed and Color Coded Indexing on Wall Plate
- Integral Service Stops with Checks to Prevent Cross Flow

Warranty

- Lifetime Limited Faucet Warranty
- 5-Year Limited Cartridge Warranty
- 1-Year Limited Finish Warranty

Codes & Standards

- ASME A112.18.1/CSA B125.1
- ASSE 1016

Job Name _____

Item Number _____

Section/Tag _____

Model Specified _____

Architect _____

Engineer _____

Contractor _____

Submitted as Shown Submitted with Variations

Date _____



Architect/Engineer Specification

Chicago Faucets No. SH-PB1-04-100, Wall Mounted Pressure Balancing Pressure Balancing Tub and Shower Valve with Shower Head and Diverter Tub Spout, Chrome Plated solid brass construction. Pressure Balancing Tub and Shower Valve Only. 5-3/8" Center to Center Tub Spout with Diverter. 2.0 GPM MAX Flow Rate @ 80 PSI Wall Mounted Institutional Shower Head. Pressure Balance Control Cartridge. 1/2" Nominal Copper and 1/2" NPT Hot and Cold Supply Inlets and Outlets. Includes Showerhead Arm and Wall Flange. Shower Valve Cycles from Cold to Hot. Embossed and Color Coded Indexing on Wall Plate. Integral Service Stops with Checks to Prevent Cross Flow. This product is tested and certified to industry standards: ASME A112.18.1/CSA B125.1, and ASSE 1016.

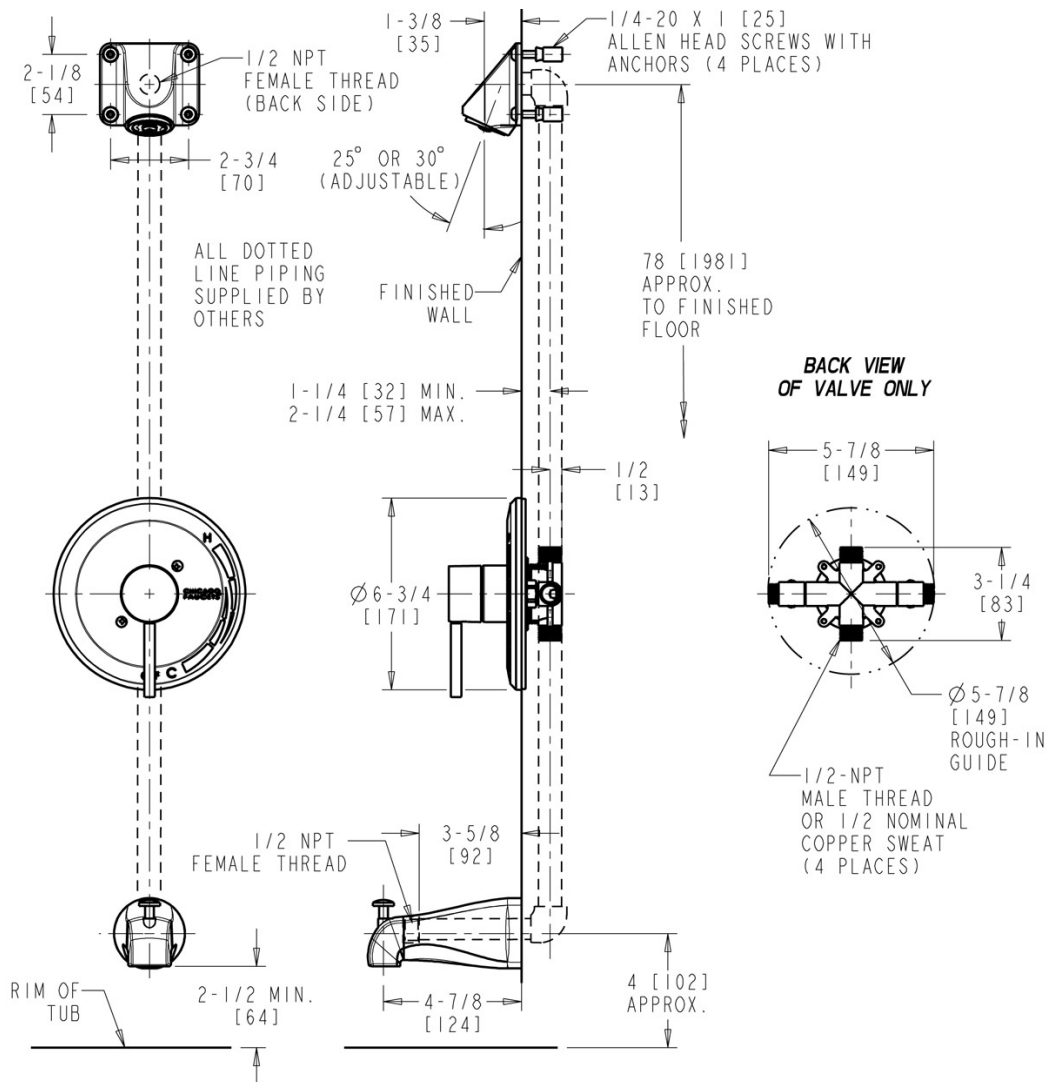

Operation and Maintenance

Installation should be in accordance with local plumbing codes. Flush all pipes thoroughly before installation. After installation, remove spout outlet or flow control and flush faucet thoroughly to clear any debris. Care should be taken when cleaning the product. Do not use abrasive cleaners, chemicals or solvents as they can result in surface damage. Use mild soap and warm water for cleaning and protecting the life of Chicago Faucet products. For specific operation and maintenance refer to the installation instructions and repair parts documents that are located at www.chicagofaucets.com.

Chicago Faucets, member of the Geberit Group, is the leading brand of commercial faucets and fittings in the United States, offering a complete range of products for schools, laboratories, hospitals, office buildings, food service, airports and sport facilities. Call 1.800.TECTRUE or 1.847.803.5000 Option 1 for installation or other technical assistance.



2100 South Clearwater Drive
Des Plaines, IL
P: 847/803-5000
F: 847/803-5454
Technical: 800/TEC-TRUE
www.chicagofaucets.com