



# DIRECTVENT PRO® DIRECT VENT SYSTEM

FORMERLY DIRECTVENT GS, DIRECTVENT PRO SETS A NEW STANDARD IN DESIGN AND CONSTRUCTION



## RE-DESIGNED, RE-ENGINEERED.

With so many innovations, DirectVent GS transformed to DirectVent Pro, offering stunning design, Engineered Excellence®, and utilizing state-of-the-art manufacturing.

Re-Designed Appearance...All black pipe lengths and elbows feature laser-welded seams for a sleek finish. Low profile locks and no hems or beads allow for a beautiful product that looks elegant in any interior.

Re-Engineered for Excellence...Tighter inner connections, no gaskets or sealants required\*. All DirectVent Pro components are compatible with DirectVent GS stock, except for the new DirectVent Pro Pipe Extensions.

\*Unless specified by the appliance manufacturer.

## REMARKABLE.

Engineered Excellence with innovation and style...DirectVent Pro... specified exclusively by nearly every major stove and fireplace manufacturer in the U.S. and Canada.

- Unitized construction eliminates field assembly of inner and outer flues.
- Twist-lock connections provide quick, positive, fastener-free installation.
- Precision pipe and fittings have been engineered for optimum appliance performance.

You can rely on DirectVent Pro to provide for safe, dependable performance from your direct vent stove or fireplace.

- Laboratory tested and listed with each appliance.
- Engineered to ensure optimum appliance performance in both vertical and horizontal vent configurations.
- Wind, rain, and thermal performance tested for safe, dependable operation.
- To eliminate flame lift-off and burnouts, DirectVent Pro features precision fittings that are factory leak tested. In most cases, Dura-Vent twist-lock adapters are built-in by the appliance manufacturer to ensure a leak-proof connection between the vent and the appliance.

## DESIGNER INSTALLATIONS MADE EASY

Simpson Dura-Vent offers the most complete product line in the industry to meet every installation need. Easy to install side-wall installations offer exciting new design options. From traditional through-the-roof installations, to fireplace inserts and wood stove conversions, DirectVent Pro has the technology and component parts to make every installation a success.

## APPLICATIONS

DirectVent Pro has been designed for use with direct vent stoves, heaters, and fireplaces. DirectVent Pro, in combination with the gas appliance, has been tested and listed as a decorative gas appliance system, or as a direct vent heater system by a major testing agency such as U.L., AGA, CGA, Warnock Hersey, or Omni.

Limited Lifetime warranty.



## HOW IT WORKS

Direct vent appliances are “sealed combustion systems.” That means the air for combustion is delivered to the appliance through the venting system from outside. As a result, direct vent appliances do not consume warm indoor air for combustion, and they are not subject to oxygen starvation, poor draft and other problems

Associated with “tight” energy efficient homes. With sealed direct vent systems, all combustion by-products are safely vented out through the venting system, eliminating fumes, water moisture, and indoor air contamination.

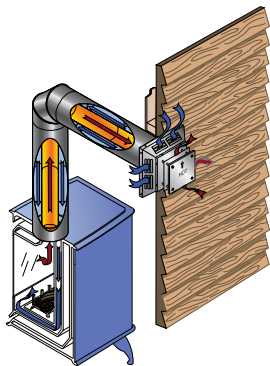

## NEW INSTALLATION FLEXIBILITY

With the introduction of direct vent gas stoves and fireplaces, and the flexibility to vent these appliances out a side wall, new exciting design options became available to the homeowner. Essentially, any room with an exterior wall is now a candidate for a direct vent gas stove or fireplace, including kitchens, baths, and bedrooms. Horizontal side-wall venting allows for other creative options, including fireplaces under stair landings and fireplaces in rooms where traditional vertical installations would not be feasible, such as rooms located under a living room or garage.

Horizontal side-wall venting also permits attractive designer installations, such as fireplaces installed under counter tops, bars, or positioned under wrap-around windows. DirectVent Pro is also available in a full range of pipe lengths and accessories to complete a traditional vertical installation. Chimney liner kits are available for installing direct vent gas stove inserts into existing wood burning fireplaces.

Modern direct vent gas stoves and fireplaces feature thermostatic temperature control, with energy efficiency equal to or greater than your gas furnace. Enjoy the new realistic gas flames, complete with glowing embers, and the convenience at the push of a button on your remote control.

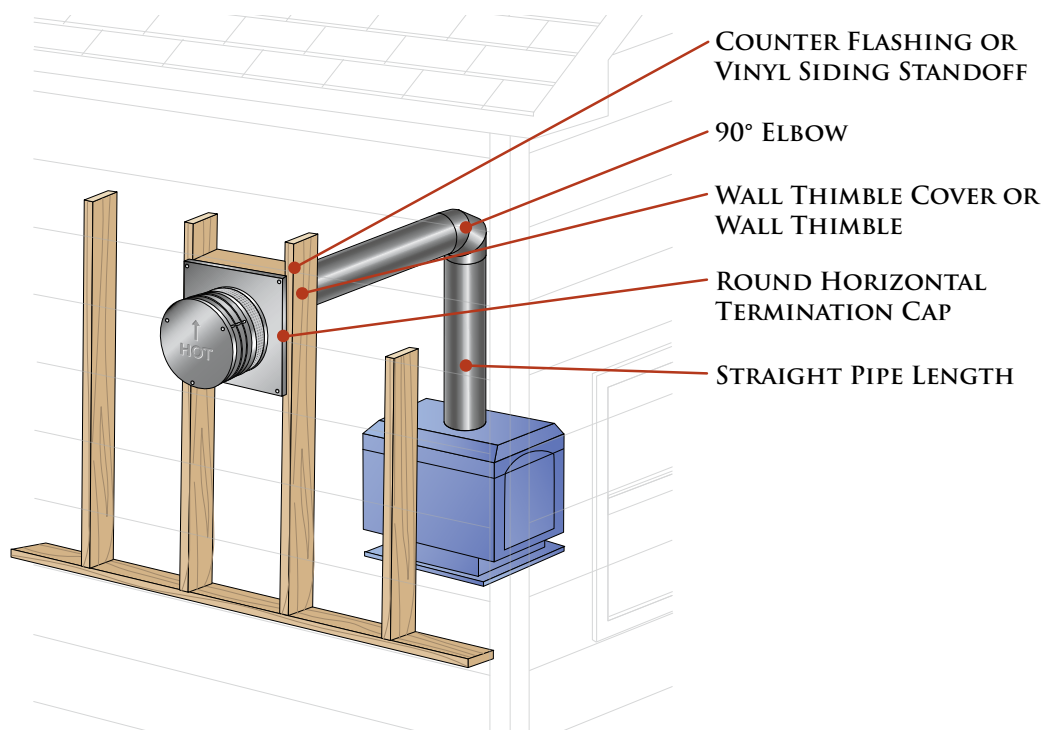
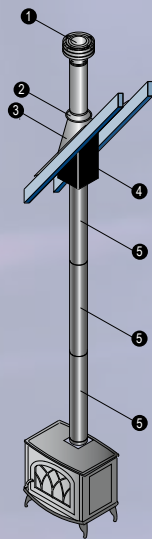

ILLUSTRATION KEY	
1	Vertical Termination Cap
2	Storm Collar
3	Flashing
4	Cathedral Ceiling Support Box
5	Pipe
6	45 Degree Elbow
7	Class A Chimney Conversion Kit
8	4" Flex
9	90 Degree Elbow
10	Round Horizontal Termination Cap
11	Snorkel Termination Cap
12	Chimney Liner Termination Kit
13	3" Flex
14	Co-Axial to Co-Linear Connector
15	Masonry Chimney Conversion Kit
16	Elbow Strap

### Typical Installations

- Refer to our Typical Venting Installation drawings to select the appropriate component parts for your installation.
- The inner and outer pipe diameters should match the outlet size of the appliance.
- Check the appliance manufacturer's installation instructions to confirm which types of vent configurations are permitted (i.e. horizontal, vertical, chimney reline, etc.). Also, check for any venting restrictions such as maximum horizontal run, minimum and maximum vertical rise, maximum offset, etc.
- Be fire-safe! Maintain the maximum clearances (air-space) between the vent pipe and nearby combustibles, as specified in the appliance manufacturer's installation instructions. Use proper support and bracing. Follow local building codes and have your venting system inspected.

**CATHEDRAL CEILING (STOVE INSTALLATION)**



**METAL CHIMNEY (CONVERSION)**

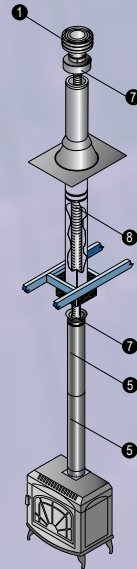

**FIREPLACE (HORIZONTAL TERM.)**

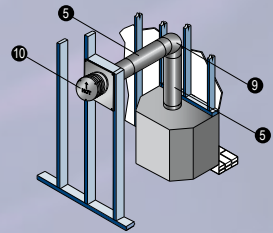

**STOVE (HORIZONTAL TERM.)**

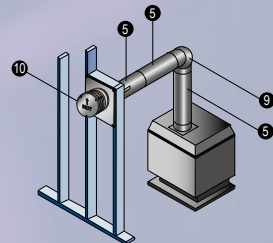

**0" CLEARANCE FIREPLACE**

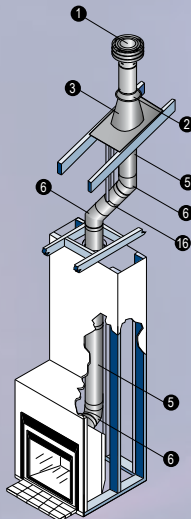

**STOVE W/SNORKEL (HORIZONTAL TERM.)**

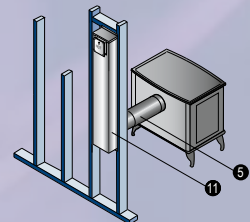

**MASONRY CHIMNEY CONVERSION**

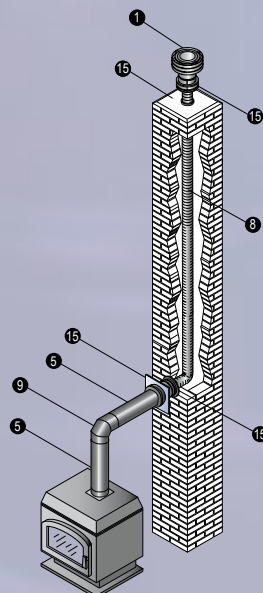

**CO-LINEAR INSERT**

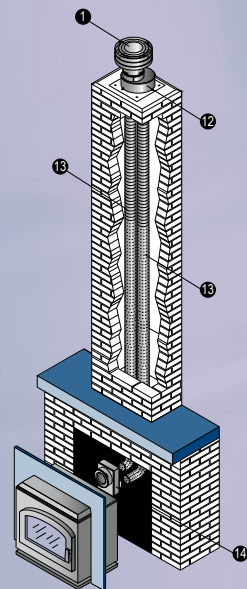

## HOW TO PLAN YOUR VENTING INSTALLATION

Step 1.	For vertical gas stove installations, measure the height from the stove outlet to the ceiling to determine the length of black pipe required. Select a round or square support box. For a designer appearance, select decorative brass trim.
Step 2.	Refer to the Typical Installations for the type of liner installation similar to your situation. Identify the needed parts for installation.
Step 3.	The size of the liner should match the outlet size on the appliance or the size of the vent/manifold that penetrates into the masonry chimney.
Step 4.	Determine the length of liner needed. When using DuraLiner, add 1 1/2" overlap per joint.
Step 5.	Make sure the top of the masonry chimney has a leveled surface to insure a proper fit for the Top Plate of the reliner and provide a secure, leak-proof installation.
Step 6.	If a free-standing appliance is used, select the vent or stovepipe pieces to connect from the appliance to the liner (refer to the appropriate Simpson Dura-Vent catalog).
Step 7.	For Installations using a Transition Anchor Plate, refer to the DuraTech or DuraPlus catalogs or installation instructions for proper parts and installation.
Step 8	Important! Check to be sure the installation complies with all local and national code requirements, including clearance to combustibles. Contact the local building inspector for permit requirements.

## DESIGN RECOMMENDATIONS

The following design recommendations are intended as only a general guideline to assist in the design and selection of venting components for your installation. Read and follow the DirectVent Pro installation instructions before installing your venting system.

Important: Check the manufacturer's rating plate and instruction manual to confirm that the Simpson Dura-Vent direct vent system is approved for use on the brand name appliance you have selected.

- The inner and outer pipe diameters should match the outlet size of the appliance.
- Check the appliance manufacturer's installation instructions to confirm which types of vent configurations are permitted. (i.e. horizontal, vertical, chimney reline, etc.). Also, check for any venting restrictions such as maximum horizontal run, minimum and maximum vertical rise, maximum offset, etc.
- Be fire-safe! Maintain the minimum clearances (air-space) between the vent pipe and nearby combustibles, as specified in the appliance manufacturer's installation instructions. Use proper support and bracing. Follow local building codes and have your venting system inspected.

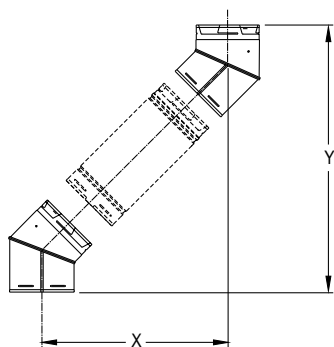

OFFSET PIPE  
Figure 1

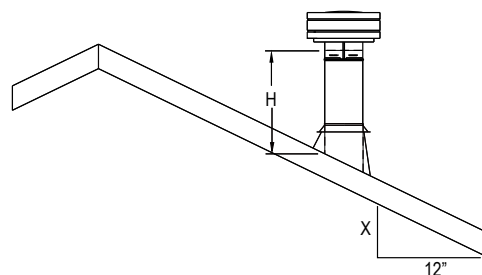

MINIMUM CHIMNEY CLEARANCE  
Figure 2