

# OPERATION MANUAL

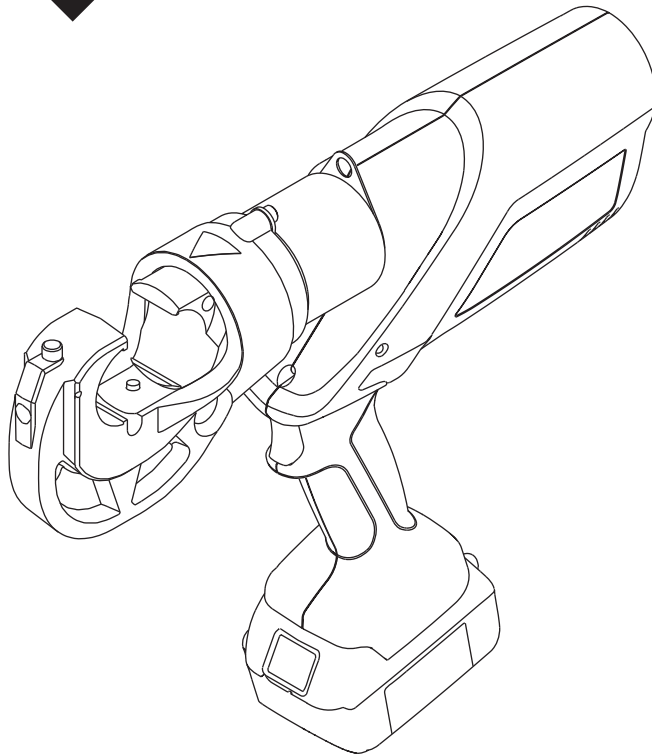

## **GATOR®** **EK1230L and EK1230CL** **Battery-powered** **Crimping Tools**



**Read and understand** all of the instructions and safety information in this manual before operating or servicing this tool.

Register this product at [www.greenlee.com](http://www.greenlee.com)

## Table of Contents

Description .....	2
Safety .....	2
Purpose of this Manual .....	2
Important Safety Information .....	3-4
Identification .....	5
Specifications .....	5
Operation .....	6-7
Die Selection .....	8
Connector Selection .....	8
Maintenance .....	9
Troubleshooting .....	10

## Description

The EK1230L Crimping Tool is a hand-held, self-contained, battery-powered tool intended to crimp aluminum and copper connectors onto electrical cable.

The EK1230CL has a PVC-covered crimping head.

This tool has a retraction stop feature which allows the operator to stop the retraction motion of the ram to shorten cycle time.

This tool is protected by U.S. Patent No. 6,206,663, 6,276,186, 6,401,515, and 6,718,870.

## Safety

Safety is essential in the use and maintenance of Greenlee tools and equipment. This manual and any markings on the tool provide information for avoiding hazards and unsafe practices related to the use of this tool. Observe all of the safety information provided.

## Purpose of this Manual

This manual is intended to familiarize all personnel with the safe operation and maintenance procedures for the following Greenlee tool:

- EK1230L Battery-powered Crimping Tool
- EK1230CL Battery-powered Crimping Tool with PVC-covered Head

Keep this manual available to all personnel.

Replacement manuals are available upon request at no charge at [www.greenlee.com](http://www.greenlee.com).



**Do not discard this product or throw away!**

For recycling information, go to [www.greenlee.com](http://www.greenlee.com).

All specifications are nominal and may change as design improvements occur. Greenlee Textron Inc. shall not be liable for damages resulting from misapplication or misuse of its products.

GATOR is a registered trademark of Greenlee Textron Inc.

Blackburn is a registered trademark of Thomas & Betts.

## **KEEP THIS MANUAL**

## IMPORTANT SAFETY INFORMATION



### SAFETY ALERT SYMBOL

This symbol is used to call your attention to hazards or unsafe practices which could result in an injury or property damage. The signal word, defined below, indicates the severity of the hazard. The message after the signal word provides information for preventing or avoiding the hazard.

#### ⚠ **DANGER**

Immediate hazards which, if not avoided, **WILL** result in severe injury or death.

#### ⚠ **WARNING**

Hazards which, if not avoided, **COULD** result in severe injury or death.

#### ⚠ **CAUTION**

Hazards or unsafe practices which, if not avoided, **MAY** result in injury or property damage.

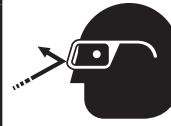

#### ⚠ **WARNING**

Wear eye protection when operating or servicing this tool.

Failure to wear eye protection could result in serious eye injury from flying debris or hydraulic oil.



#### ⚠ **WARNING**

Skin injection hazard:

Do not use hands to check for oil leaks. Oil under pressure easily punctures skin. If injured, seek medical attention immediately to remove oil.

Failure to observe this warning could result in serious injury, gangrene, or death.



#### ⚠ **WARNING**

Do not use solvents or flammable liquids to clean the tool body. Solvents or flammable liquids could ignite and cause serious injury or property damage.



#### ⚠ **WARNING**

Read and understand all of the instructions and safety information in this manual before operating or servicing this tool.

Failure to observe this warning could result in severe injury or death.



#### ⚠ **WARNING**

Electric shock hazard:

This tool is not insulated. When using this unit on or near energized electrical lines, use proper personal protective equipment.

Failure to observe this warning could result in severe injury or death.

#### ⚠ **WARNING**

An incomplete crimp can cause a fire.

- Use proper die, connector, and cable combinations. Improper combinations can result in an incomplete crimp.
- The relief valve sounds and the ram automatically retracts to indicate a completed crimp. If you do not hear the sound of the relieve valve or the ram does not automatically retract, the crimp is not complete.

Failure to observe these warnings could result in severe injury or death.

## IMPORTANT SAFETY INFORMATION

	<b>⚠ WARNING</b>
	Pinch points: <ul style="list-style-type: none"><li>• Remove battery before changing dies, adapters, or jaws.</li><li>• Keep hands away from the crimping tool head when crimping.</li></ul> Failure to observe these warnings could result in severe injury or death.

<b>⚠ WARNING</b>
Do not dispose of batteries in a fire. They will vent fumes and may explode. Failure to observe this warning could result in severe injury from harmful fumes or burns from flying debris.

<b>⚠ WARNING</b>
Inspect tool and dies before use. Replace any worn or damaged parts. A damaged or improperly assembled tool can break and strike nearby personnel. Failure to observe this warning could result in severe injury or death.

<b>⚠ CAUTION</b>
<ul style="list-style-type: none"><li>• Do not use this tool for continuous use. After 30 to 40 cycles, allow the tool to cool for 15 minutes.</li><li>• Do not secure this tool in a vise. This tool is designed for hand-held operation.</li><li>• This tool may be used in damp or wet environments; however, air-drying is recommended before use if the tool becomes soaked. Damage may result when the tool is operated prior to thorough drying when electrical components are soaked.</li><li>• Use this tool for the manufacturer's intended purpose only.</li></ul> Failure to observe these precautions may result in injury or property damage.

<b>⚠ CAUTION</b>
Do not allow anything to contact the battery terminals. <ul style="list-style-type: none"><li>• Do not immerse the batteries in liquid. Liquid may create a short circuit and damage the battery. If batteries are immersed, contact your service center for proper handling.</li><li>• Do not place the battery into a pocket, tool pouch, or tool box with conductive objects. Conductive objects may create a short circuit and damage the battery.</li><li>• Do not place a battery on moist ground or grass. Moisture may create a short circuit and damage the battery.</li></ul> Failure to observe these precautions may result in injury or property damage.

<b>⚠ CAUTION</b>
<ul style="list-style-type: none"><li>• Do not store the battery at more than 122 °F (50 °C) or less than -4 °F (-20 °C). Damage to the battery can result.</li><li>• Do not use another manufacturer's charger. Other manufacturers' chargers may overcharge and damage the battery.</li><li>• Do not attempt to open the battery. It contains no user-serviceable parts.</li></ul> Failure to observe these precautions may result in injury or property damage.

<b>⚠ CAUTION</b>
Do not perform any service or maintenance other than as described in this manual. Injury or damage to the tool may result. Failure to observe this precaution may result in injury and property damage.

*Note: Keep all decals clean and legible, and replace when necessary.*

## Identification

### EK1230L and EK1230CL

1. LED Work Light (white)
2. Crimping Head
3. Die Release Buttons
4. Lanyard Ring
5. Housing
6. Retract Button
7. LED Indicator (red)
8. Battery
9. Trigger

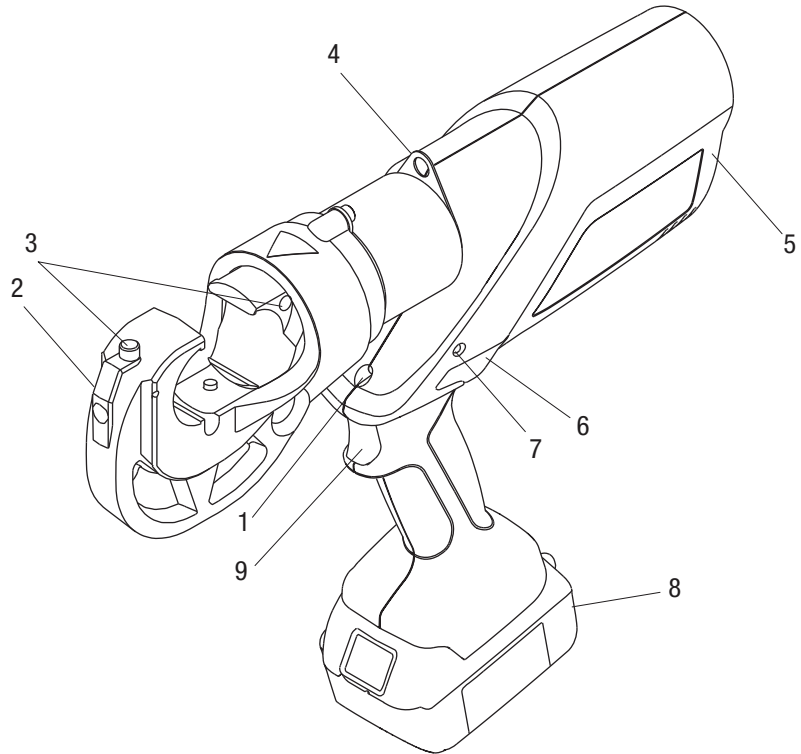

## Specifications

### Crimping Tool

Length .....	14.5" (371 mm)
Width .....	2.87" (72.9 mm)
Height (with battery) .....	12.03" (306 mm)
Weight .....	15.5 lb (7.0 kg)
Crimping Force.....	12 tons (106 kN)
Hydraulic Oil.....	52057878 biodegradable hydraulic fluid
Recommended Operating Temperature Range.....	5 °F to 122 °F (-15 °C to 50 °C)

### Crimping Capacities

Crimping Range ..... 8 AWG to 750 kcmil

Battery Charger .....Read the instructions supplied with the battery charger

52047087	120 VAC corded adapter	52049202	230 VAC, 18 V charger
52047088	230 VAC corded adapter	52049204	12 VDC, 18 V charger
52049189	18 V, 3 Ah lithium-ion battery	52054992	Li (18 V) to NiCd, NiMH (12 V) charger adapter
52049201	120 VAC, 18 V charger	50122746	Carrying strap

## Operation

### ⚠ WARNING

Inspect tool and dies before use. Replace any worn or damaged parts. A damaged or improperly assembled tool can break and strike nearby personnel.

Failure to observe this warning could result in severe injury or death.

### ⚠ WARNING



Electric shock hazard:

This tool is not insulated. When using this unit on or near energized electrical lines, use proper personal protective equipment.

Failure to observe this warning could result in severe injury or death.

### ⚠ WARNING

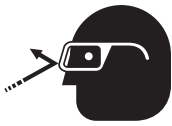

Wear eye protection when operating or servicing this tool.

Failure to wear eye protection could result in serious eye injury from flying debris or hydraulic oil.

### ⚠ WARNING



Pinch points:

- Remove battery before changing dies, adapters, or jaws.
- Keep hands away from the crimping tool head when crimping.

Failure to observe these warnings could result in severe injury or death.

### ⚠ CAUTION

- Do not use this tool for continuous use. After 30 to 40 cycles, allow the tool to cool for 15 minutes.
- Do not secure this tool in a vise. This tool is designed for hand-held operation.
- This tool may be used in damp or wet environments; however, air-drying is recommended before use if the tool becomes soaked. Damage may result when the tool is operated prior to thorough drying when electrical components are soaked.
- Use this tool for the manufacturer's intended purpose only.

Failure to observe these precautions may result in injury or property damage.

### Charging the Battery

Read the instructions supplied with the battery charger.

### LED Work Light (white)

This LED automatically turns on when the trigger is pulled. It remains on for 10 seconds after the trigger is released.

### LED Indicator (red)

This tool is equipped with a special circuit board incorporating several important features to inform the user about the current status of the unit. The LED signals in the following cases:

What happens	Signal	What it means
Flashing light for 2 seconds	● ●	Battery is inserted in tool
Constant light for 20 seconds at end of cycle	▬	Battery charge is below 17 V at beginning of cycle
Tool will <b>not</b> start, and constant light for 20 seconds when trigger is released	▬	Battery charge is below 16 V at beginning of cycle
Tool will stop, and constant light for 20 seconds after trigger is released	▬	Battery voltage drops below 13 V during cycle
Tool will stop, and flashing light for 20 seconds when trigger is released	● ● ● ●	Motor current exceeds 20 A during cycle Circuit has become too hot

### Pressure Sensor

This tool is equipped with a pressure sensor that alerts the user of an incomplete crimp.

- If the tool is manually retracted before completion of a crimp, the red LED and an audible beep will be active for 2 seconds.
- If the tool is unable to reach the required crimp force, the red LED, work light, and an audible beep will pulse until after the trigger is released.

## Operation (cont'd)

### Procedure

1. Clean the die seat area.
2. Install the proper size and type of crimping dies.
3. Press the release button on the C-head and slide one of the die halves into the jaw. Release the button and slide the die half until the retainer snaps and locks the die into place.
4. Press the release button on the ram body (located in the cutout) and slide the other die half in. Release the button and slide the die half until the retainer snaps and locks the die into place.
5. Follow the connector manufacturer's instructions for appropriate cable strip length and surface preparation.
6. Insert cable fully into connector and center the connector between the dies.
7. Using the sequence illustrated here, press the trigger to advance the dies. Continue to crimp until the pressure relief valve activates.  
*Note: Pressure relief occurs at approximately 106 kN (12 tons) and is indicated by an audible "pop."*
8. After achieving pressure relief, the ram automatically returns to the start position and the dies retract.
9. To stop the ram from returning fully, activate the trigger for a brief moment. This activation will close the retraction valve and stop the retraction motion.
10. When using KC12-type dies, complete the number of crimps listed on the "Connector Selection" chart in this manual. For other dies, complete the number of crimps specified by the manufacturer.
11. Remove the connector from the crimping tool.

*Note: After completing the last crimp on an aluminum connector, wipe off the excess oxide inhibitor.*

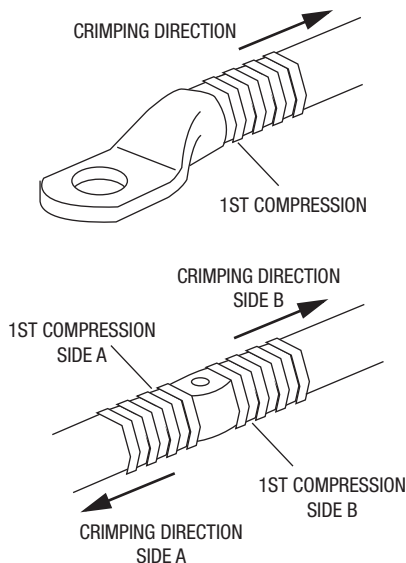

### **⚠ WARNING**

An incomplete crimp can cause a fire.

- Use proper die, connector, and cable combinations. Improper combinations can result in an incomplete crimp.
- The relief valve sounds and the ram automatically retracts to indicate a completed crimp. If you do not hear the sound of the relieve valve or the ram does not automatically retract, the crimp is not complete.

Failure to observe these warnings could result in severe injury or death.

## Die Selection

Refer to “Connector Selection” for brand names and model numbers of appropriate lugs as well as crimping instructions.

Crimps made with this tool and KC12-type or KA12-type dies are cUL and UL classified when used with the appropriate conductor and connectors listed below.

### Dies for Copper Connectors

Catalog No.	UPC No.	Cable Size	Color Code	No. of Crimps
KC12-8	10996	8 AWG	Red	1
KC12-6	10997	6 AWG	Blue	1
KC12-4	10998	4 AWG	Gray	1
KC12-2	10999	2 AWG	Brown	1
KC12-1	11003	1 AWG	Green	1
KC12-1/0	11004	1/0 AWG	Pink	1
KC12-2/0	11007	2/0 AWG	Black	1
KC12-3/0	11010	3/0 AWG	Orange	1
KC12-4/0	11011	4/0 AWG	Purple	1
KC12-250	11012	250 kcmil	Yellow	1
KC12-300	11013	300 kcmil	White	2
KC12-350	11014	350 kcmil	Red	2
KC12-400	11015	400 kcmil	Blue	2
KC12-500	11016	500 kcmil	Brown	2
KC12-600	11018	600 kcmil	Green	2
KC12-750	11020	750 kcmil	Black	2

### Dies for Aluminum Connectors

Catalog No.	UPC No.	Cable Size	Color Code	No. of Crimps
KA12-8	22084	8 AWG	Blue	1
KA12-6	22085	6 AWG	Gray	1
KA12-4	22086	4 AWG	Green	1
KA12-2	22087	2 AWG	Pink	1
KA12-1	22088	1 AWG	Gold	1
KA12-1/0	22089	1/0 AWG	Tan	1
KA12-2/0	22090	2/0 AWG	Olive	2
KA12-3/0	22121	3/0 AWG	Ruby	2
KA12-4/0	22122	4/0 AWG	White	2
KA12-250	22123	250 kcmil	Red	2
KA12-300	22124	300 kcmil	Blue	2
KA12-350	22125	350 kcmil	Brown	2
KA12-400	22126	400 kcmil	Green	3
KA12-500	22127	500 kcmil	Pink	3
KA12-600	22128	600 kcmil	Black	3
KA12-750	22129	750 kcmil	Yellow	3

## Connector Selection (NOT for use with flex, navy or welding wire)

**Tool Range:** 8 AWG to 750 kcmil

When used with KC12-type dies, this tool is cUL and UL classified for use with the following connector brands:

CONNECTOR TYPE	BARREL TYPE	ANDERSON	BLACKBURN®	BURNDY	ILSCO	PANDUIT	T&B	PENN-UNION	NUMBER OF CRIMPS*
Copper Splices	Short	VHSS	CSP	YS-L	CT	SCSS SCS	54504 to 54523-TB	BCU	8 AWG to 250 kcmil: 1 crimp
	Long	VHS	CU	YS	CTL	SCL SCH	54804 to 54823	BBCU	
Copper Lugs	Short	VHCS	CTL-2/CTL	YA-2LN/ YA-L/YA-2L; YA/YA-L-TC/ YA-L-2TC	CSW CRA/CRB CRC	LCAS LCA LCD LCAN	54104 to 54123-TB; 54204 to 54223	BLU	300 to 750 kcmil: 2 crimps
	Long	VHCL	CTL-L/LCN	YA/YAZ YA-2N/YA-2TC YAZ-2N/YAZ-2TC	CLN, CLW CRA-L/CRB-L CRA-2/CRB-2L CRC-2L	LCB LCC	54930BE to 54923BE; 54850BE to 54880BE	BBLU	

When used with KA12-type dies, this tool is cUL and UL classified for use with the following connector brands:

CONNECTOR TYPE	ANDERSON	BLACKBURN®	BURNDY	ILSCO	PANDUIT	T&B	PENN-UNION	NUMBER OF CRIMPS*
Dual-rated Aluminum Splices	VACS	ASP	YS-A	AS	SA	60501 to 60578	PIK	8 to 1/0 AWG: 1 crimp
Dual-rated Aluminum Lugs	VACL	ATL	YA-A YA-ATN	ACL/ACN 2ACL/2ACN	LAA LAB	60101 to 60176; 60230 to 60278	BLUA	2/0 AWG to 350 kcmil: 2 crimps  400 to 750 kcmil: 3 crimps





\* Use the number of crimps listed in this column instead of the number provided with the connector.

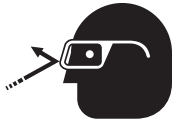

## Maintenance

	<b>⚠ WARNING</b>
	<p>Wear eye protection when operating or servicing this tool.</p> <p>Failure to wear eye protection could result in serious eye injury from flying debris or hydraulic oil.</p>

	<b>⚠ WARNING</b>
	<p>Skin injection hazard:</p> <p>Do not use hands to check for oil leaks. Oil under pressure easily punctures skin. If injured, seek medical attention immediately to remove oil.</p> <p>Failure to observe this warning could result in serious injury, gangrene, or death.</p>

	<b>⚠ WARNING</b>
	<p>Do not use solvents or flammable liquids to clean the tool body. Solvents or flammable liquids could ignite and cause serious injury or property damage.</p>

	<b>⚠ WARNING</b>
	<p>Pinch points:</p> <ul style="list-style-type: none"> <li>• Remove battery before changing dies, adapters, or jaws.</li> <li>• Keep hands away from the crimping tool head when crimping.</li> </ul> <p>Failure to observe these warnings could result in severe injury or death.</p>

<b>IMPORTANT</b>
Relief valve adjustments must be done by an authorized service center.

### Daily

*Before use:*

1. Inspect the tool for wear or damage, such as cracks, gouges, or chips.
2. Inspect the tool for damage or leaks.
3. Inspect the rotation of the head assembly. Fully retract the ram. The head should rotate no more than 360°. If damage is detected, send the tool to a Greenlee Authorized Service Center for inspection.

*After use:*

1. Use a damp cloth and mild detergent to clean the housing. Allow the housing to dry.
2. Fully retract the ram. Place the tool in the carrying case and store in a cool, dry place.
3. If necessary, recharge the batteries. Refer to the instructions supplied with the battery charger.

### Monthly

1. Thoroughly clean all surfaces.
2. Check the oil level.

### Annually or After 10,000 Crimps

1. Replace the hydraulic oil.
2. Send the tool to a Greenlee Authorized Service Center for inspection.

### Checking the Oil Level

1. Remove the screws holding the housing cover together.
2. Point the crimping head downward and remove the oil reservoir plug. Fill reservoir if necessary.
3. Replace the oil plug and housing cover.

## Troubleshooting

### Before You Begin

1. Make sure that the battery is charged. Recheck the battery after several minutes to make sure the battery is holding its charge.
2. Use a **nonflammable** contact cleaner or pencil eraser to clean the electrical contacts on the battery and tool.
3. Reinstall the battery and check the tool again.

Problem	Possible Cause	Probable Remedy
Tool is inoperative.	Dirt, contaminants, etc., in ram area of tool.	Clean tool.
	Tool battery contacts damaged.	Reform contacts.
	Tool components worn or damaged.	Return tool to a Greenlee Authorized Service Center.
Motor is inoperative.	Low or uncharged battery.	Try known charged battery. Inoperative battery may be discharged or may have reached life expectancy.
	Broken switch components.	Return tool to a Greenlee Authorized Service Center.
Motor runs but tool will not complete a cycle.	Oil level low.	Return tool to a Greenlee Authorized Service Center.
	Air in hydraulic system.	Pull trigger and hold retract button simultaneously. Run for approximately 10 seconds, and then attempt to crimp. If unsuccessful, return tool to a Greenlee Authorized Service Center.
	Cold oil.	Pull trigger and hold retract button simultaneously to warm oil. Store tool in warm area.
Dies stop during operation.	Oil level low.	Return tool to a Greenlee Authorized Service Center.
	Air in hydraulic system.	Pull trigger and hold retract button simultaneously. Hold for approximately 10 seconds.
LED glows for 20 seconds.	Battery charge low.	Charge or replace battery.
Tool loses oil.	Damaged internal seal.	Return tool to a Greenlee Authorized Service Center.