

INSTRUCTION MANUAL

Rotary Hammer

HR2800
HR2810
HR2810T
HR2811F
HR2811FT

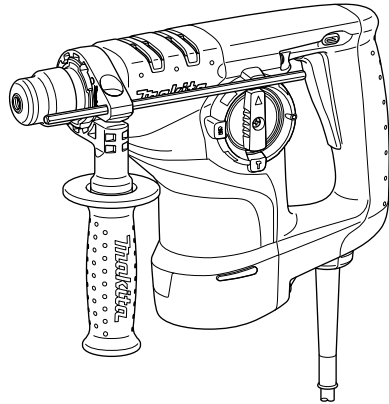

008203



IMPORTANT: Read Before Using.

ENGLISH (Original instructions)

SPECIFICATIONS

Model		HR2800/ HR2810	HR2810T	HR2811F	HR2811FT
Capacities	Concrete	Tungsten-carbide tipped bit	28 mm		
		Core bit	80 mm		
		Diamond core bit (dry type)	80 mm		
	Steel	13 mm			
	Wood	32 mm			
No load speed (min ⁻¹)		0 - 1,100			
Blows per minute		0 - 4,500			
Overall length		314 mm	339 mm	320 mm	345 mm
Net weight		3.4 kg	3.5 kg	3.5 kg	3.6 kg
Safety class		□/II			

- Due to our continuing program of research and development, the specifications herein are subject to change without notice.
- Specifications may differ from country to country.
- Weight according to EPTA-Procedure 01/2003

END201-5

Symbols

The following show the symbols used for the equipment. Be sure that you understand their meaning before use.



- Read instruction manual.



- DOUBLE INSULATION



- Only for EU countries
Do not dispose of electric equipment together with household waste material!

In observance of European Directive 2002/96/EC on waste electric and electronic equipment and its implementation in accordance with national law, electric equipment that have reached the end of their life must be collected separately and returned to an environmentally compatible recycling facility.

For Model HR2800

ENE042-1

Intended use

The tool is intended for hammer drilling and drilling in brick, concrete and stone.

It is also suitable for drilling without impact in wood, metal, ceramic and plastic.

For Model HR2810, HR2810T, HR2811F, HR2811FT

ENE043-1

Intended use

The tool is intended for hammer drilling and drilling in brick, concrete and stone as well as for chiselling work. It is also suitable for drilling without impact in wood, metal, ceramic and plastic.

ENF002-2

Power supply

The tool should be connected only to a power supply of the same voltage as indicated on the nameplate, and can only be operated on single-phase AC supply. They are double-insulated and can, therefore, also be used from sockets without earth wire.

ENG905-1

Noise

The typical A-weighted noise level determined according to EN60745:

Model HR2800

Sound pressure level (L_{pA}) : 89 dB(A)
Sound power level (L_{WA}) : 100 dB(A)
Uncertainty (K) : 3 dB(A)

Model HR2810, HR2810T

Sound pressure level (L_{pA}) : 89 dB(A)
Sound power level (L_{WA}) : 100 dB(A)
Uncertainty (K) : 3 dB(A)

Model HR2811F, HR2811FT

Sound pressure level (L_{pA}) : 90 dB(A)
Sound power level (L_{WA}) : 101 dB(A)
Uncertainty (K) : 3 dB(A)

Wear ear protection

ENG900-1

Vibration

The vibration total value (tri-axial vector sum) determined according to EN60745:

Model HR2800

Work mode : hammer drilling into concrete

Vibration emission ($a_{h,HD}$) : 20.0 m/s²

Uncertainty (K) : 1.5 m/s²

Work mode: drilling into metal

Vibration emission ($a_{h,D}$) : 2.5 m/s² or less

Uncertainty (K) : 1.5 m/s²

Model HR2810, HR2810T

Work mode : chiselling

Vibration emission ($a_{h,CHeg}$) : 15.5 m/s²

Uncertainty (K) : 1.5 m/s²

Work mode : hammer drilling into concrete

Vibration emission ($a_{h,HD}$) : 20.0 m/s²

Uncertainty (K) : 1.5 m/s²

Work mode: drilling into metal

Vibration emission ($a_{h,D}$) : 2.5 m/s² or less

Uncertainty (K) : 1.5 m/s²

Model HR2811F, HR2811FT

Work mode : chiselling

Vibration emission ($a_{h,CHeg}$) : 11.5 m/s²

Uncertainty (K) : 1.5 m/s²

Work mode : hammer drilling into concrete

Vibration emission ($a_{h,HD}$) : 15.0 m/s²

Uncertainty (K) : 1.5 m/s²

Work mode: drilling into metal

Vibration emission ($a_{h,D}$) : 2.5 m/s²

Uncertainty (K) : 1.5 m/s²

ENG901-1

- The declared vibration emission value has been measured in accordance with the standard test method and may be used for comparing one tool with another.
- The declared vibration emission value may also be used in a preliminary assessment of exposure.

WARNING:

- The vibration emission during actual use of the power tool can differ from the declared emission value depending on the ways in which the tool is used.

- Be sure to identify safety measures to protect the operator that are based on an estimation of exposure in the actual conditions of use (taking account of all parts of the operating cycle such as the times when the tool is switched off and when it is running idle in addition to the trigger time).

ENH101-16

For European countries only

EC Declaration of Conformity

We Makita Corporation as the responsible manufacturer declare that the following Makita machine(s):

Designation of Machine:

Rotary Hammer

Model No./ Type: HR2800, HR2810, HR2810T, HR2811F, HR2811FT

are of series production and

Conforms to the following European Directives:

2006/42/EC

And are manufactured in accordance with the following standards or standardised documents:

EN60745

The technical documentation is kept by:

Makita International Europe Ltd.

Technical Department,

Michigan Drive, Tongwell,

Milton Keynes, Bucks MK15 8JD, England

30.01.2009



000230

Tomoyasu Kato

Director

Makita Corporation

3-11-8, Sumiyoshi-cho,

Anjo, Aichi, 446-8502, JAPAN

GEA005-3

General Power Tool Safety Warnings

 **WARNING** Read all safety warnings and all instructions. Failure to follow the warnings and instructions may result in electric shock, fire and/or serious injury.

Save all warnings and instructions for future reference.

The term "power tool" in the warnings refers to your mains-operated (corded) power tool or battery-operated (cordless) power tool.

Work area safety

1. **Keep work area clean and well lit.** Cluttered or dark areas invite accidents.
2. **Do not operate power tools in explosive atmospheres, such as in the presence of flammable liquids, gases or dust.** Power tools create sparks which may ignite the dust or fumes.
3. **Keep children and bystanders away while operating a power tool.** Distractions can cause you to lose control.

Electrical safety

4. **Power tool plugs must match the outlet. Never modify the plug in any way. Do not use any adapter plugs with earthed (grounded) power tools.** Unmodified plugs and matching outlets will reduce risk of electric shock.
5. **Avoid body contact with earthed or grounded surfaces such as pipes, radiators, ranges and refrigerators.** There is an increased risk of electric shock if your body is earthed or grounded.
6. **Do not expose power tools to rain or wet conditions.** Water entering a power tool will increase the risk of electric shock.
7. **Do not abuse the cord. Never use the cord for carrying, pulling or unplugging the power tool. Keep cord away from heat, oil, sharp edges or moving parts.** Damaged or entangled cords increase the risk of electric shock.
8. **When operating a power tool outdoors, use an extension cord suitable for outdoor use.** Use of a cord suitable for outdoor use reduces the risk of electric shock.
9. **If operating a power tool in a damp location is unavoidable, use a residual current device (RCD) protected supply.** Use of an RCD reduces the risk of electric shock.
10. **Use of power supply via a RCD with a rated residual current of 30mA or less is always recommended.**

Personal safety

11. **Stay alert, watch what you are doing and use common sense when operating a power tool. Do not use a power tool while you are tired or under the influence of drugs, alcohol or medication.** A moment of inattention while operating power tools may result in serious personal injury.
12. **Use personal protective equipment. Always wear eye protection.** Protective equipment such as dust mask, non-skid safety shoes, hard hat, or hearing protection used for appropriate conditions will reduce personal injuries.
13. **Prevent unintentional starting. Ensure the switch is in the off-position before connecting to power source and/or battery pack, picking**

up or carrying the tool. Carrying power tools with your finger on the switch or energising power tools that have the switch on invites accidents.

14. **Remove any adjusting key or wrench before turning the power tool on.** A wrench or a key left attached to a rotating part of the power tool may result in personal injury.
15. **Do not overreach. Keep proper footing and balance at all times.** This enables better control of the power tool in unexpected situations.
16. **Dress properly. Do not wear loose clothing or jewellery. Keep your hair, clothing, and gloves away from moving parts.** Loose clothes, jewellery or long hair can be caught in moving parts.
17. **If devices are provided for the connection of dust extraction and collection facilities, ensure these are connected and properly used.** Use of dust collection can reduce dust-related hazards.

Power tool use and care

18. **Do not force the power tool. Use the correct power tool for your application.** The correct power tool will do the job better and safer at the rate for which it was designed.
19. **Do not use the power tool if the switch does not turn it on and off.** Any power tool that cannot be controlled with the switch is dangerous and must be repaired.
20. **Disconnect the plug from the power source and/or the battery pack from the power tool before making any adjustments, changing accessories, or storing power tools.** Such preventive safety measures reduce the risk of starting the power tool accidentally.
21. **Store idle power tools out of the reach of children and do not allow persons unfamiliar with the power tool or these instructions to operate the power tool.** Power tools are dangerous in the hands of untrained users.
22. **Maintain power tools. Check for misalignment or binding of moving parts, breakage of parts and any other condition that may affect the power tool's operation. If damaged, have the power tool repaired before use.** Many accidents are caused by poorly maintained power tools.
23. **Keep cutting tools sharp and clean.** Properly maintained cutting tools with sharp cutting edges are less likely to bind and are easier to control.
24. **Use the power tool, accessories and tool bits etc. in accordance with these instructions, taking into account the working conditions and the work to be performed.** Use of the power tool for operations different from those

intended could result in a hazardous situation.

Service

25. **Have your power tool serviced by a qualified repair person using only identical replacement parts.** This will ensure that the safety of the power tool is maintained.
26. **Follow instruction for lubricating and changing accessories.**
27. **Keep handles dry, clean and free from oil and grease.**

GEB007-7

ROTARY HAMMER SAFETY WARNINGS

1. **Wear ear protectors.** Exposure to noise can cause hearing loss.
2. **Use auxiliary handle(s), if supplied with the tool.** Loss of control can cause personal injury.
3. **Hold power tool by insulated gripping surfaces, when performing an operation where the cutting accessory may contact hidden wiring or its own cord.** Cutting accessory contacting a "live" wire may make exposed metal parts of the power tool "live" and could give the operator an electric shock.
4. **Wear a hard hat (safety helmet), safety glasses and/or face shield.** Ordinary eye or sun glasses are NOT safety glasses. It is also highly recommended that you wear a dust mask and thickly padded gloves.
5. **Be sure the bit is secured in place before operation.**
6. **Under normal operation, the tool is designed to produce vibration. The screws can come loose easily, causing a breakdown or accident. Check tightness of screws carefully before operation.**
7. **In cold weather or when the tool has not been used for a long time, let the tool warm up for a while by operating it under no load. This will loosen up the lubrication. Without proper warm-up, hammering operation is difficult.**
8. **Always be sure you have a firm footing. Be sure no one is below when using the tool in high locations.**
9. **Hold the tool firmly with both hands.**
10. **Keep hands away from moving parts.**
11. **Do not leave the tool running. Operate the tool only when hand-held.**
12. **Do not point the tool at any one in the area when operating. The bit could fly out and injure someone seriously.**
13. **Do not touch the bit or parts close to the bit immediately after operation; they may be extremely hot and could burn your skin.**
14. **Some material contains chemicals which may be toxic. Take caution to prevent dust inhalation and skin contact. Follow material supplier safety data.**

SAVE THESE INSTRUCTIONS.

WARNING:

DO NOT let comfort or familiarity with product (gained from repeated use) replace strict adherence to safety rules for the subject product. **MISUSE** or failure to follow the safety rules stated in this instruction manual may cause serious personal injury.

FUNCTIONAL DESCRIPTION

⚠CAUTION:

- Always be sure that the tool is switched off and unplugged before adjusting or checking function on the tool.

Switch action

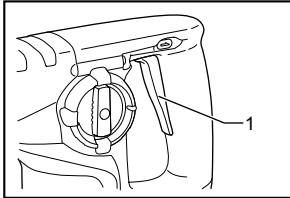

1. Switch trigger

008204

⚠CAUTION:

- Before plugging in the tool, always check to see that the switch trigger actuates properly and returns to the "OFF" position when released.

To start the tool, simply pull the switch trigger. Tool speed is increased by increasing pressure on the switch trigger. Release the switch trigger to stop.

Lighting up the lamps

For Models HR2811F, HR2811FT

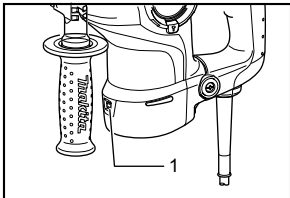

1. Lamp

008235

⚠CAUTION:

- Do not look in the light or see the source of light directly.

To turn on the lamp, pull the trigger. Release the trigger to turn it off.

NOTE:

- Use a dry cloth to wipe the dirt off the lens of lamp. Be careful not to scratch the lens of lamp, or it may lower the illumination.

Reversing switch action

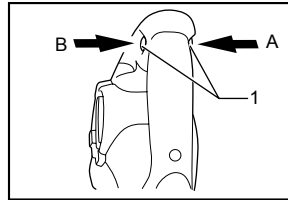

1. Reversing switch lever

008205

This tool has a reversing switch to change the direction of rotation. Depress the reversing switch lever from the A side for clockwise rotation or from the B side for counterclockwise rotation.

⚠CAUTION:

- Always check the direction of rotation before operation.
- Use the reversing switch only after the tool comes to a complete stop. Changing the direction of rotation before the tool stops may damage the tool.
- When you operate the tool in counterclockwise rotation, the switch trigger is pulled only halfway and the tool runs at half speed.

Changing the quick change chuck for SDS-plus

For model HR2810T, HR2811FT

The quick change chuck for SDS-plus can be easily exchanged for the quick change drill chuck.

Removing the quick change chuck for SDS-plus

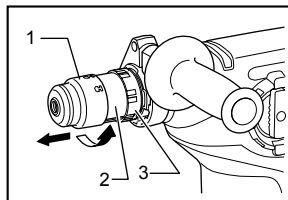



1. Quick change chuck for SDS-plus
2. Change cover line
3. Change cover

008233

⚠CAUTION:

- Before removing the quick change chuck for SDS-plus, always remove the bit.

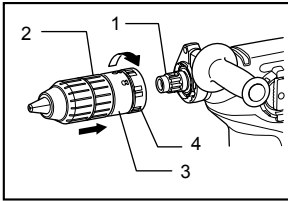

Grasp the change cover of the quick change chuck for SDS-plus and turn in the direction of the arrow until the change cover line moves from the  symbol to the  symbol. Pull forcefully in the direction of the arrow.

Attaching the quick change drill chuck



1. Spindle
2. Quick change drill chuck
3. Change cover line
4. Change cover

008234

Check the line of the quick change drill chuck shows the  symbol. Grasp the change cover of the quick change drill chuck and set the line to the  symbol.

Place the quick change drill chuck on the spindle of the tool.

Grasp the change cover of the quick change drill chuck and turn the change cover line to the  symbol until a click can clearly be heard.

Selecting the action mode

For Model HR2800

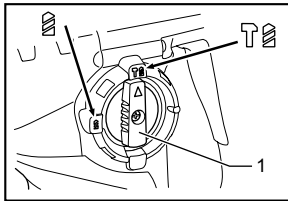

1. Action mode changing knob

008236

This tool employs an action mode changing knob. Select one of the two modes suitable for your work needs by using this knob.

For rotation only, turn the knob so that the arrow on the knob points toward the  symbol on the tool body.

For rotation with hammering, turn the knob so that the arrow on the knob points toward the  symbol on the tool body.

CAUTION:

- Always set the knob fully to your desired mode symbol. If you operate the tool with the knob positioned halfway between the mode symbols, the tool may be damaged.
- Use the knob after the tool comes to a complete stop.

For models HR2810, HR2810T, HR2811F, HR2811FT Rotation with hammering

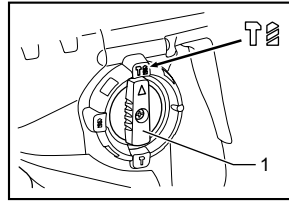

1. Action mode changing knob

008206

For drilling in concrete, masonry, etc., rotate the action mode changing knob to the  symbol. Use a tungsten-carbide tipped bit.

Rotation only

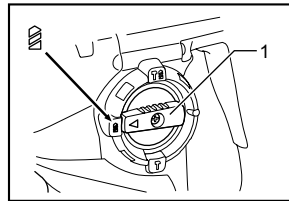

1. Action mode changing knob

008207

For drilling in wood, metal or plastic materials, lock button and rotate the action mode changing knob to the  symbol. Use a twist drill bit or wood bit.

Hammering only

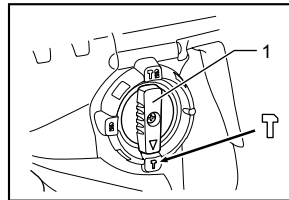

1. Action mode changing knob

008208

For chipping, scaling or demolition operations, rotate the action mode changing knob to the  symbol. Use a bull point, cold chisel, scaling chisel, etc.

CAUTION:

- Do not rotate the action mode changing knob when the tool is running under load. The tool will be damaged.
- To avoid rapid wear on the mode change mechanism, be sure that the action mode changing knob is always positively located in one of the three action mode positions.

Torque limiter

The torque limiter will actuate when a certain torque level is reached. The motor will disengage from the

output shaft. When this happens, the bit will stop turning.

⚠ CAUTION:

- As soon as the torque limiter actuates, switch off the tool immediately. This will help prevent premature wear of the tool.
- Bits such as hole saw, which tend to pinch or catch easily in the hole, are not appropriate for this tool. This is because they will cause the torque limiter to actuate too frequently.

ASSEMBLY

⚠ CAUTION:

- Always be sure that the tool is switched off and unplugged before carrying out any work on the tool.

Side grip (auxiliary handle)

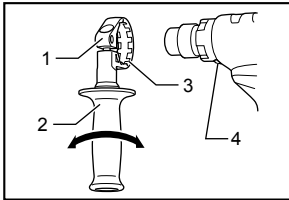

008209

1. Grip base
2. Side grip
3. Teeth
4. Protrusion

⚠ CAUTION:

- Always use the side grip to ensure operating safety.

Install the side grip so that the teeth on the grip fit in between the protrusions on the tool barrel. Then tighten the grip by turning clockwise at the desired position. It may be swung 360° so as to be secured at any position.

Bit grease

Coat the bit shank head beforehand with a small amount of bit grease (about 0.5 - 1 g).

This chuck lubrication assures smooth action and longer service life.

Installing or removing the bit

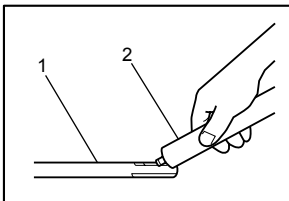

003150

1. Bit shank
2. Bit grease

Clean the bit shank and apply bit grease before installing the bit.

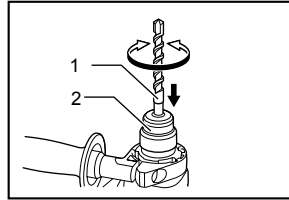

008210

1. Bit
2. Chuck cover

Insert the bit into the tool. Turn the bit and push it in until it engages.

After installing, always make sure that the bit is securely held in place by trying to pull it out.

To remove the bit, pull the chuck cover down all the way and pull the bit out.

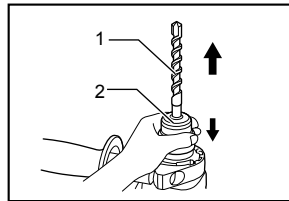

008211

1. Bit
2. Chuck cover

Bit angle (when chipping, scaling or demolishing)

For models HR2810, HR2810T, HR2811F, HR2811FT

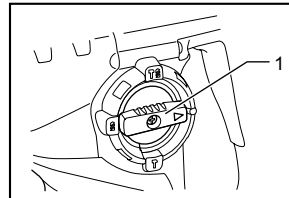

008237

1. Action mode changing knob

The bit can be secured at the desired angle. To change the bit angle, rotate the action mode changing knob to the O symbol. Turn the bit to the desired angle.

Rotate the action mode changing knob to the ∇ symbol. Then make sure that the bit is securely held in place by turning it slightly.

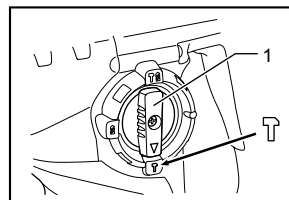

008208

1. Action mode changing knob

Depth gauge

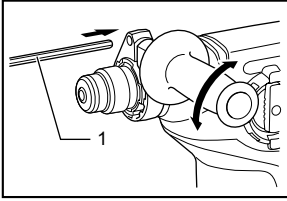

1. Depth gauge

008212

The depth gauge is convenient for drilling holes of uniform depth. Loosen the side grip and insert the depth gauge into the hole in the side grip. Adjust the depth gauge to the desired depth and tighten the side grip.

NOTE:

- The depth gauge cannot be used at the position where the depth gauge strikes against the gear housing.

Dust cup

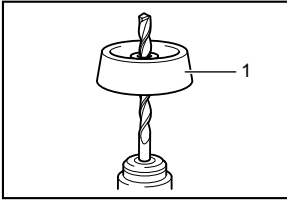

1. Dust cup

001300

Use the dust cup to prevent dust from falling over the tool and on yourself when performing overhead drilling operations. Attach the dust cup to the bit as shown in the figure. The size of bits which the dust cup can be attached to is as follows.

	Bit diameter
Dust cup 5	6 mm - 14.5 mm
Dust cup 9	12 mm - 16 mm

006406

OPERATION

⚠CAUTION:

- Always use the side grip (auxiliary handle) and firmly hold the tool by both side grip and switch handle during operations.

Hammer drilling operation

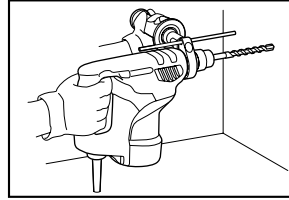

008213

Set the action mode changing knob to the  symbol. Position the bit at the desired location for the hole, then pull the switch trigger.

Do not force the tool. Light pressure gives best results. Keep the tool in position and prevent it from slipping away from the hole.

Do not apply more pressure when the hole becomes clogged with chips or particles. Instead, run the tool at an idle, then remove the bit partially from the hole. By repeating this several times, the hole will be cleaned out and normal drilling may be resumed.

⚠CAUTION:

- There is a tremendous and sudden twisting force exerted on the tool/bit at the time of hole breakthrough, when the hole becomes clogged with chips and particles, or when striking reinforcing rods embedded in the concrete. Always use the side grip (auxiliary handle) and firmly hold the tool by both side grip and switch handle during operations. Failure to do so may result in the loss of control of the tool and potentially severe injury.

NOTE:

Eccentricity in the bit rotation may occur while operating the tool with no load. The tool automatically centers itself during operation. This does not affect the drilling precision.

Blow-out bulb (optional accessory)

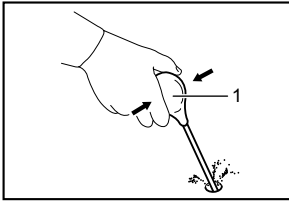

1. Blow-out bulb

002449

After drilling the hole, use the blow-out bulb to clean the dust out of the hole.

Chipping/Scaling/Demolition

For models HR2810, HR2810T, HR2811F, HR2811FT only

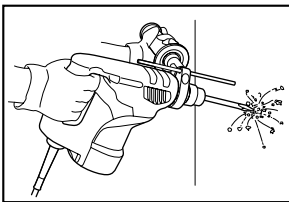

008214

Set the action mode changing knob to the  symbol. Hold the tool firmly with both hands. Turn the tool on and apply slight pressure on the tool so that the tool will not bounce around, uncontrolled. Pressing very hard on the tool will not increase the efficiency.

Drilling in wood or metal

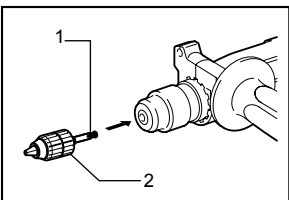

1. Chuck adapter
2. Keyless drill chuck

004223

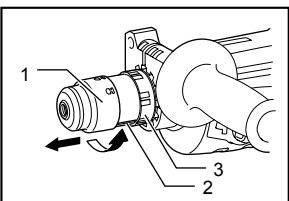

1. Quick change chuck for SDS-plus
2. Change cover line
3. Change cover

007944

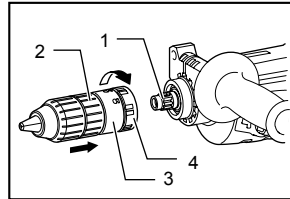

007945

1. Spindle
2. Quick change drill chuck
3. Change cover line
4. Change cover

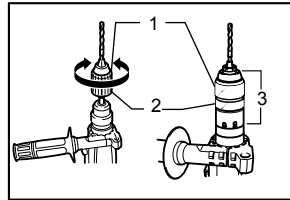

004224

1. Sleeve
2. Ring
3. Quick change drill chuck

For Model HR2800, HR2810, HR2810F

Use the optional drill chuck assembly. When installing it, refer to "Installing or removing the bit" described on the previous page.

Set the action mode changing knob so that the pointer points to the  symbol.

For model HR2810T, HR2811FT

Use the quick change drill chuck as standard equipment. When installing it, refer to "changing the quick change chuck for SDS-plus" described on the previous page.

Hold the ring and turn the sleeve counterclockwise to open the chuck jaws. Place the bit in the chuck as far as it will go. Hold the ring firmly and turn the sleeve clockwise to tighten the chuck. To remove the bit, hold the ring and turn the sleeve counterclockwise.

Set the action mode changing knob to the  symbol. You can drill up to 13 mm diameter in metal and up to 32 mm diameter in wood.

⚠CAUTION:

- Never use "rotation with hammering" when the quick change drill chuck is installed on the tool. The quick change drill chuck may be damaged. Also, the drill chuck will come off when reversing the tool.
- Pressing excessively on the tool will not speed up the drilling. In fact, this excessive pressure will only serve to damage the tip of your bit, decrease the tool performance and shorten the service life of the tool.
- There is a tremendous twisting force exerted on the tool/bit at the time of hole breakthrough. Hold the tool firmly and exert care when the bit begins to break through the workpiece.

- A stuck bit can be removed simply by setting the reversing switch to reverse rotation in order to back out. However, the tool may back out abruptly if you do not hold it firmly.
- Always secure small workpieces in a vise or similar hold-down device.

Diamond core drilling

When performing diamond core drilling operations, always set the change lever to the  position to use "rotation only" action.

CAUTION:

- If performing diamond core drilling operations using "rotation with hammering" action, the diamond core bit may be damaged.

MAINTENANCE

CAUTION:

- Always be sure that the tool is switched off and unplugged before attempting to perform inspection or maintenance.
- Never use gasoline, benzine, thinner, alcohol or the like. Discoloration, deformation or cracks may result.

To maintain product SAFETY and RELIABILITY, repairs, carbon brush inspection and replacement, any other maintenance or adjustment should be performed by Makita Authorized Service Centers, always using Makita replacement parts.

OPTIONAL ACCESSORIES

CAUTION:

- These accessories or attachments are recommended for use with your Makita tool specified in this manual. The use of any other accessories or attachments might present a risk of injury to persons. Only use accessory or attachment for its stated purpose.

If you need any assistance for more details regarding these accessories, ask your local Makita Service Center.

- SDS-Plus Carbide-tipped bits
- Bull point
- Core bit
- Cold chisel
- Diamond core bit
- Scaling chisel
- Grooving chisel
- Drill chuck assembly
- Drill chuck S13
- Chuck adapter
- Chuck key S13
- Bit grease

- Side grip
- Depth gauge
- Blow-out bulb
- Dust cup
- Dust extractor attachment
- Safety goggles
- Plastic carrying case
- Keyless drill chuck

NOTE:

- Some items in the list may be included in the tool package as standard accessories. They may differ from country to country.

Makita Corporation
Anjo, Aichi, Japan

884729C220

www.makita.com