

Models 5022/5522

Barrett™

Swirl-way® Rectangular Whirlpools and Bathtub



Bathtub and Whirlpool Features

- 66" x 42" x 24" rectangular bathtub
- Sculpted armrests and lumbar backrest
- Two pillows
- Drop-in or undermount installation
- Two-person tub
- Mansfield® Limited Ten Year Warranty
- Available in standard colors (white, almond, biscuit and bone) and premium colors (British khaki, sterling silver, black and ice gray)



Basic Whirlpool Features





- Hydro-V back jet system
- Single speed pump
- 1-button electronic keypad
- Color match trim
- Dual air controls

Luxury Whirlpool Features



- Hydro-V back jet system
- Variable speed pump
- 5-button electronic keypad with digital temperature readout
- Metal trim upgrades
- Chromotherapy system
- In-line heater

Model 5022LUX

Options

Cable Drain			Lift and Turn Drain		
Model #	Description		Model #	Description	
SW1319	Standard Colors		PF1320	Polished Chrome	
SW1320	Polished Chrome		PF1321	Everbrass (PVD)	
SW1321	Everbrass (PVD)		PF1322	Brushed Nickel	
SW1322	Brushed Nickel		PF1323	Oil Rubbed Bronze	
SW1323	Oil Rubbed Bronze				
SWP150	Factory Installed Nailing Flange		SWA100	Rainbow Pillow	

Whirlpool Options

Metal Trim			In-line water heater		
Model #	Description		Model #	Description	
SW1335	Chrome		SWP151	In-line water heater	
SW1336	Everbrass (PVD)				
SW1337	Brushed Nickel				
SW1338	Oil Rubbed Bronze				



MADE IN USA

Models 5022/5522

Barrett™

Swirl-way® Rectangular Whirlpools and Bathtub



Specifications

Model #	Description	Codes/Standards
5522	66" X 42" X 24" Rectangular Bathtub	  
5022BAS	66" X 42" X 24" Basic Whirlpool Package	
5022LUX	66" X 42" X 24" Luxury Whirlpool Package	

Specification	Description	Specification	Description
Material	Acrylic, fiberglass reinforced	Number of Jets	16
Construction	Self-contained, pre-plumbed whirlpool bath, with heat-bent rigid PVC pipe, mounted on a pre-leveled base	Water Capacity	65 gal. (min.) / 80 gal. (max.)
Pump Motor	Basic: 1.5 HP Single speed induction pump Luxury: 1.5 HP Variable speed induction pump	Floor Loading Weight	47 lbs. / sq. ft. (229 kg/m ²)
Electrical Requirements	Basic: One 120V, 20 Amp, GFCI dedicated circuit. Optional heater: separate 120V, 20 Amp, GFCI dedicated circuit. Luxury: Two separate 120V, 20 Amp, GFCI dedicated circuits.	Shipping Weight	whirlpool - 165 lbs. bathtub - 145 lbs.
On/Off Control	Basic: 1-button electronic control pad Luxury: 5-button electronic control pad with digital readout showing temperature of water, speed of pump and time remaining in 20-minute cycle.	Warranty	Limited Ten Year

Technical Information

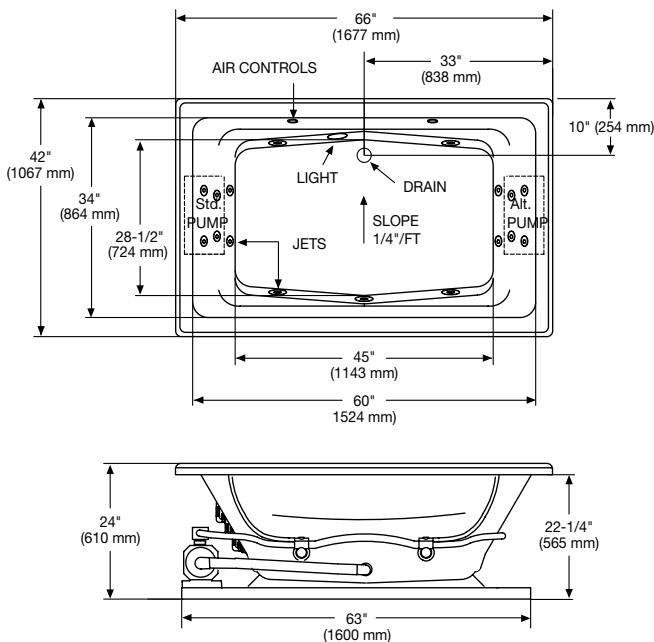

Pump locations are shown for clarity.
STD-standard pump location.
ALT1-alternate pump location.

Note: Install this product according to the installation guide.

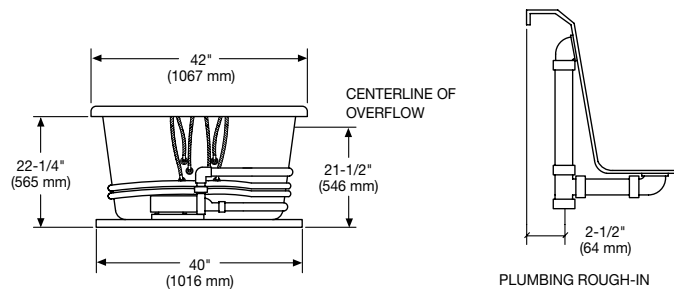

Rough-in measurements may vary 1/4" (+/-)

These dimensions are nominal and subject to change without notice.

When tested for compliance to the requirements of ASME A112.19.7M for "Whirlpool Bath Appliances" and ANSI Z124.1.2M "American National Standard for Plastic Bathtub and Shower Units", the tested units are found to comply and are acceptable for listing under IAPMO R & T.

Certified for permanent electrical connection only.



MADE IN USA