

# Models 9085/9185/9285

## Elba OV™

Ariance® Oval Air Massage Bath



### Features

- 59-1/2" x 42" x 23" Oval air massage bath
- Three advanced therapy air bath systems
- Multifunctional digital controller
- Chromotherapy system
- PerfectBack™ — Multiple soothing recessed back jets with heated neck/backrest
- Heated SilentAir™ system — Quiet single/dual air blowers
- QuickDrain™ channel and automatic purge system
- Color-Match trim for air jets — Optional finishes available
- Cable drain with matching trim (optional)
- One pillow
- Mansfield® Limited Ten Year Warranty
- Available in standard colors (white, almond, biscuit and bone) and premium colors (British khaki, sterling silver, black and ice gray)



Model 9285

### Options

#### Cable Drain

Model #	Description
SW1319	Standard Colors
SW1320	Polished Chrome
SW1321	Everbrass (PVD)
SW1322	Brushed Nickel
SW1323	Oil Rubbed Bronze



#### Metal Trim

Model #	Description
AR1335	Chrome
AR1336	Everbrass (PVD)
AR1337	Brushed Nickel
AR1338	Oil Rubbed Bronze

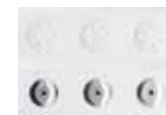

AR1200	Blower relocation kit	SWA100	Rainbow Pillow
--------	-----------------------	--------	----------------



**MADE IN USA**



# Models 9085/9185/9285

## Elba OV™

Ariance® Oval Air Massage Bath



### Specifications

Model #	Description	Codes/Standards
9085	59-1/2" x 42" x 23" Oval HealthTouch™ Air Massage Bath	  
9185	59-1/2" x 42" x 23" Oval GentleTouch™ Air Massage Bath	
9285	59-1/2" x 42" x 23" Oval DualTherapy™ Air Massage Bath	

Specification	Description	Specification	Description
Material	Acrylic, fiberglass reinforced	Number of Jets	HealthTouch - 43 perimeter, side/back air jets GentleTouch - 54 body/foot micro air jets (9 injectors and 12 side/back jets) DualTherapy - 43 perimeter, side/back air jets and 54 body/foot micro air jets (9 injectors with 12 side/back jets)
Water Capacity	50 gal. (min.) / 70 gal. (max.)		
Construction	Self-contained, pre-plumbed air massage bath, mounted on a pre-leveled base		
Electrical Requirements	Health and GentleTouch – One 120v, 20 Amp, GFCI dedicated circuit DualTherapy – Two 120v, 20 Amp, GFCI dedicated circuits	On/Off Control:	Health and GentleTouch – 5-button electronic control pad DualTherapy – 10-button electronic control pad
Blower	HealthTouch & GentleTouch one variable speed, 120v, 60 Hz, 9.5 Amp, pre-mounted DualTherapy two variable speed, 120v, 60 Hz, 9.5 Amp, pre-mounted	Shipping Weight	155 lbs. - HealthTouch/GentleTouch 170 lbs. - DualTherapy
		Floor Loading Weight	47 lbs. / sq. ft. (229 kg/m <sup>2</sup> )
		Warranty	Limited Ten Year

### Technical Information

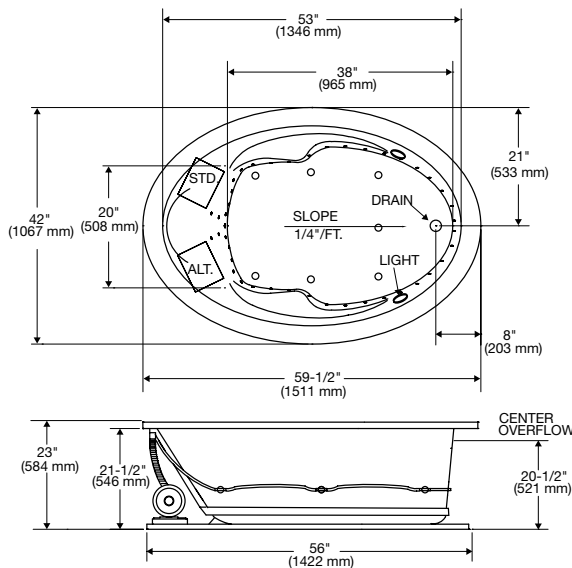

No apron available on this model.

Blower locations are shown for clarity.  
STD - standard blower location  
ALT - alternative blower location.

Note: Install this product according to the installation guide.

INSTALLER NOTE: DUE TO THE FREEFORM SHAPE OF THIS TUB IT IS RECOMMENDED THAT THE TUB BE ON THE JOBSITE BEFORE MAKING THE FINAL CUT OUT FOR DROP IN INSTALLATION.

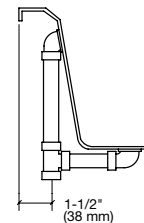
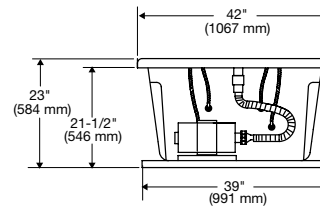

PLUMBING ROUGH-IN

These dimensions are nominal and subject to change without notice.

When tested for compliance to the requirements of ASME A112.19.7M for "Whirlpool Bath Appliances" and ANSI Z124.1.2M "American National Standard for Plastic Bathtub and Shower Units", the tested units are found to comply and are acceptable for listing under IAPMO R & T.

Certified for permanent electrical connection only.



**MADE IN USA**