



ENGINEERING EXCELLENCE

Motegi Series #3MT178 PARTS BREAKDOWN SHEET

DESCRIPTION

- Single Handle Lavatory Faucet
- Metal Lever Handle
- Straight Spout
- 3-3/4" Reach, 10-7/8" from Deck to Aerator
- Ceramic Disc Cartridge with Temperature Limit Stop
- 1-Hole Installation

FINISHES

- PC PVD Polished Chrome
- BN PVD Brushed Nickel
- SS PVD Stainless Steel
- PN PVD Polished Nickel
- PB PVD Polished Brass
- ORB Oil Rubbed Bronze



#3MT178 SHOWN * ADA 

STANDARDS APPLICABLE

- ASME A112.18.1
- ANSI A117.1
- ANSI / NSF 61, SECTION 9
- CUPC / IAPMO LISTED / ADA COMPLIANT
- CONTAINS NO MORE THAN 0.25% WEIGHTED AVERAGE LEAD CONTENT

FLOW

- Aerator Limited to 1.5 GPM



Model #: _____

Specific Features: _____

Project Name: _____

Submitted For: _____

Model	Description	Finishes	
#3MT178	Single Handle Lavatory Faucet	<input type="checkbox"/> PC	<input type="checkbox"/> Other__



ENGINEERING EXCELLENCE

Pioneer:1-800-338-9468
 Commerce, CA 90040
 www.pioneerind.com
 Pioneer Industries, Inc. © 2013

DMPB3MT178/REV. 12 2012
 Page 1 of 2

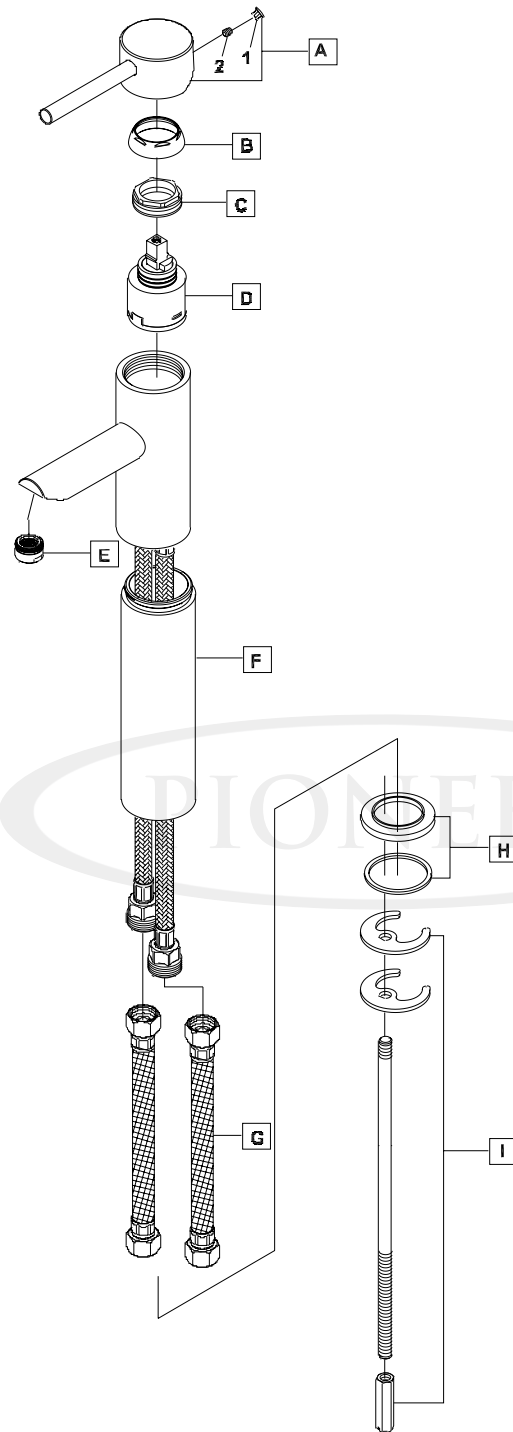

	ITEM#	DESCRIPTION
A	X-1900008*	Motegi Lever Handle
B	X-4900017*	Retainer Sleeve
C	X-4900018	Retainer Nut
D	X-3900001	Ceramic Disc Cartridge
E	X-4900089*	1.5 GPM Aerator
F	X-4300022*	8" Extension
G	X-4300084	Flex Hose
H	X-4300019*	Escutcheon
I	X-5300008	Mounting Kit
1	X-4900044*	Hole Cover
2	X-4900002	3/32" Allen Screw

* Note: Please specify finish/color when ordering.

Product Diagram



ENGINEERING EXCELLENCE

Pioneer: 1-800-338-9468
 Commerce, CA 90040
 www.pioneerind.com
 Pioneer Industries, Inc. © 2013