

Liberty Pumps®

Pump Specifications

Water Powered Back Up System SJ10 and SJ10A Sump Jet®

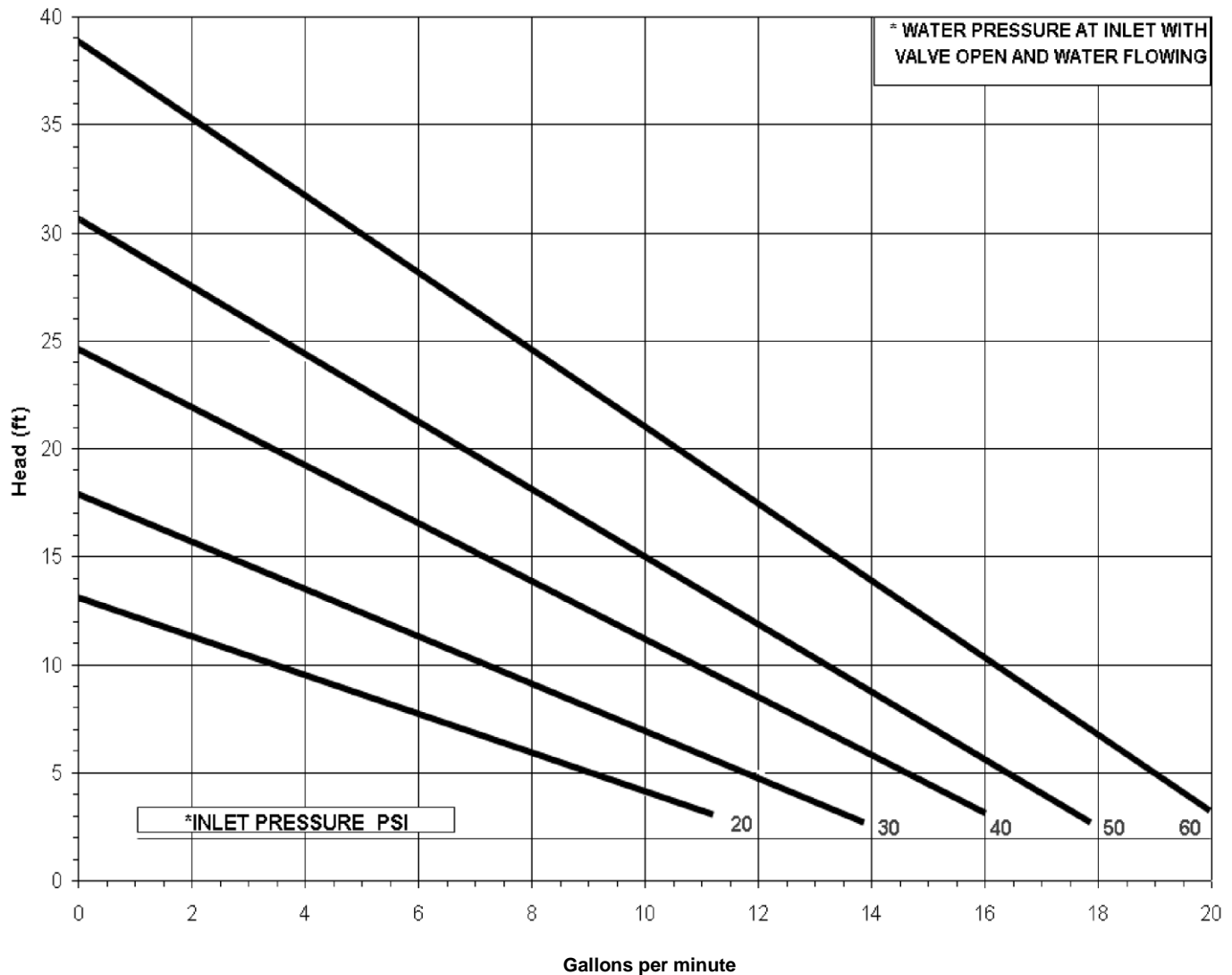
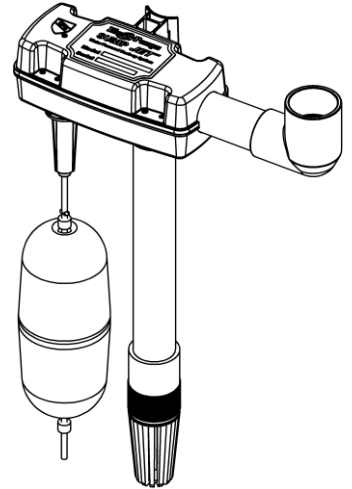

SJ10 / SJ10A - Series Dimensional Data

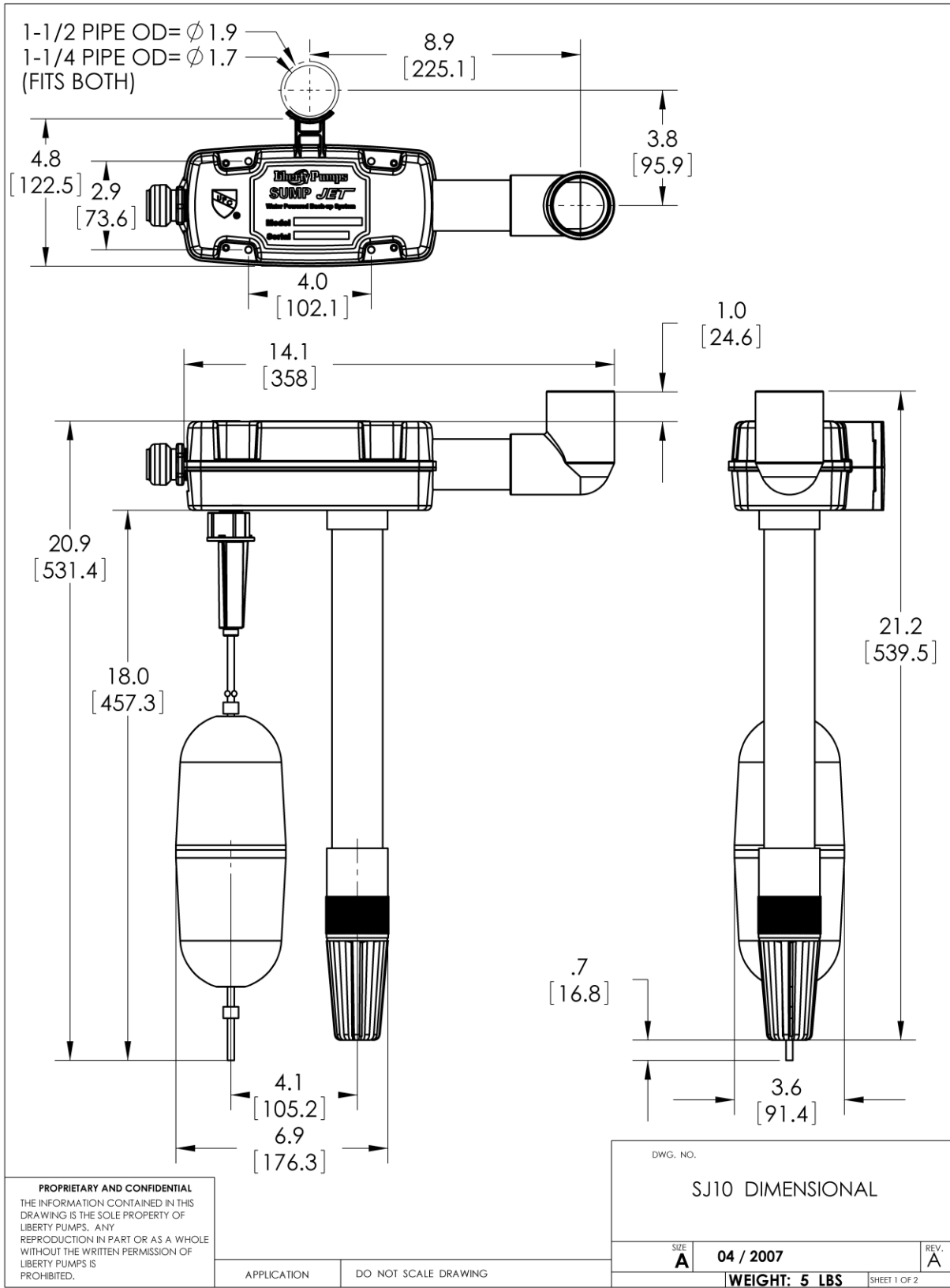

SJ10 / SJ10A- Operating Data

WATER PRESSURE AT INLET WITH VALVE OPEN AND WATER FLOWING		SUMP WATER REMOVAL AT VARIOUS HEADS. (STATIC HEAD IN 1-1/2 PIPE OR LARGER)											
		LIFT		4FT		1.21 M	8FT		2.4 M	12 FT		3.6 M	15 FT
PSI	KPA	GPM	GPH	M ³ / HR	GPM	GPH	M ³ / HR	GPM	GPH	M ³ / HR	GPM	GPH	M ³ / HR
20	138	11.0	660	2.5	5.8	348	1.3						
30	207	12.8	765	2.9	9	540	2.0	5.5	330	1.2			
40	276	15.4	924	3.5	12.5	750	2.8	9.3	558	2.1	7.2	432	1.6
50	345	17.2	1032	3.9	14.5	870	3.3	12	720	2.7	10	600	2.3
60	414	19.8	1185	4.5	17	1020	3.9	15.2	912	3.5	13.5	810	3.1

SJ10 / SJ10A - Series Technical Data

COVER	ABS PLASTIC
PIPE	UPC SCHEDULE 40 PVC
DIAPHRAGM SWITCH	NORYL BODY, SS PLUNGER 100 PSI MAX OPERATING
BACK FLOW CHECK VALVE	NEOPERL / ACETAL BODY, LISTED ASME A112.18.3 and ASME A112.18.1
NOZZLE / VENTURI	PVC PLASTIC
FOOT VALVE	PVC BODY SS SPRING LOADED POPPET
FLOAT	ABS PLASTIC
FLOAT ROD	STAINLESS STEEL
FLOAT ROD GUIDE	ACETAL PLASTIC
FASTENERS	SS
*ALARM	AUDIBLE AND VISUAL NOTIFICATION WITH REMOTE CONTACTS, 9V BATTERY BACK-UP (*SJ10A ONLY)
WEIGHT	6 LBS

SJ10 / SJ10A - Series Specifications

1.01 GENERAL:

The contractor shall provide labor, material, equipment, and incidentals required to provide _____(QTY) water powered back up pumps as specified herein. The pump models covered in this specification are Series SJ10.

2.01 OPERATING CONDITIONS:

Each water powered back up pump shall produce _____G.P.M. at _____ feet of total dynamic head.

The water powered back up pump shall be capable of handling clear sump water. The water powered back up pump shall flow a minimum of 9 GPM @ 8ft of head with an operating pressure of 30 psi. The water powered back up pump shall be supplied with a ¾" municipal water line. Per UPC an approved RPZ backflow prevention device is required to prevent backflow into the municipal water system.

3.01 CONSTRUCTION:



Each water powered back up pump shall be equal to the IAPMO approved series SJ10 water powered back up pumps as manufactured by Liberty Pumps, Bergen NY. . All components are made of tough non corrosive engineered polymers, stainless steel or brass. This construction meets IAPMO standard PS 119-2007 requirements for pressure, strength, performance, and safety.

4.01 SWITCH / VALVE ASSEMBLY

The body of the switch shall be of nylon construction. The diaphragm shall be constructed of fiber reinforced nitrile. All metal components are stainless steel. The switch / valve shall be opened and closed by a float operated neodymium magnet.

5.01 BUILT IN BACK WATER PREVENTION DEVICE

The water powered back up pump shall provide an internally installed back flow prevention device equal to Neoperl OV20 check valve for the inlet water supply. The OV20 is a UPC approved device, IAPMO file 4374, and in compliance with ASME A112.18.3-2002 and ASME A112.18.1/CSA B125.1.2005. The device shall be provided with a foot valve, to provide further protection in the event of a valve failure.

6.01 SUPPORT

The water powered back up pump shall have a means of support enabling it to easily installed by clamping to an existing pipe or fastening to a board.

7.01 SERVICEABILITY

Components required for the repair of the pump shall be shipped within a period of 24 hours.

8.01 TESTING

The pump shall have an air test performed to it to ensure that the diaphragm switch / float assembly operates, that the foot valve is functional and that the nozzle – venture arrangement is working.

9.01 QUALITY CONTROL

The pump shall be manufactured in an ISO 9001 certified Facility.

10.01 WARRANTY

Standard limited warranty shall be 3 years.