



*600FG/620FG/900FG/915FG/920FG
Optional Hinge/Latch Construction

ORDER INFORMATION SUPPLEMENT

Hinge/Latch Variation Options:

- Add \$24.00 to list for optional hinge/latch construction

Standard Construction:

- Hinges/Latches on longest dimension standard
- Blades run parallel to the first dimension standard

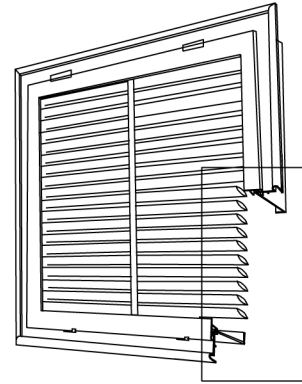

Not Available in FG series

See Detail Below

Long Blade FG's

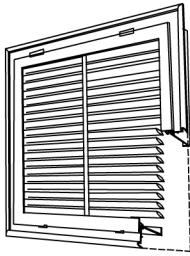

A-Hinge
Top
(Standard)

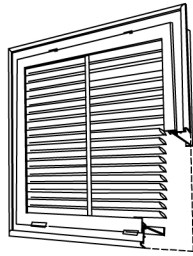

*B-Hinge
Bottom

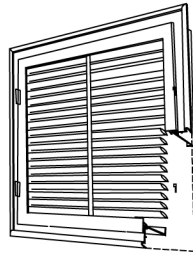

*C-Hinge
Left

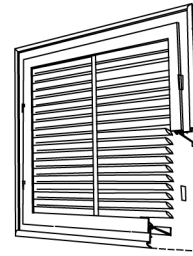

*D-Hinge
Right

Short Blade FG's



E-Hinge
Left
(Standard)



*F-Hinge
Right

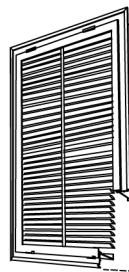

*G-Hinge
Top

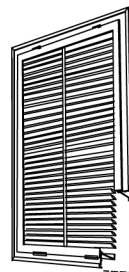

*H-Hinge
Bottom

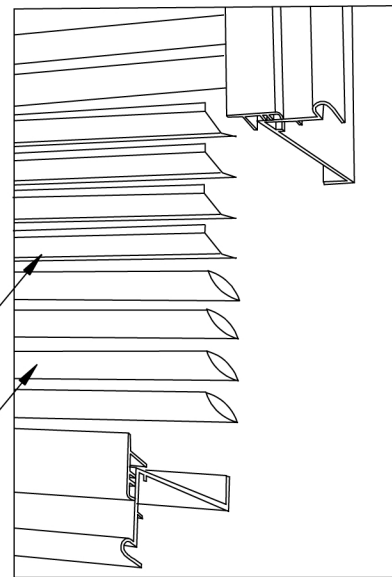

Fix Bar 915 Blade
Air Foil 900 Blade

Detail View of Right Front
Corner Blade Angle

600FG/620FG Optional
Hinge/Latch
Construction:

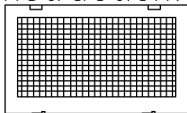

A
(Standard)

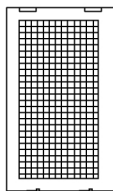

B

To Order Example:
920FG 20X30 Hinge Option G