



Submittal Sheet

Part Description:
 6" PVC WHITE Sewer 45 Degree (1/8) Bend
 or Elbow H X H

Part Number:
 414186BC

Approvals and Listings maintained by:
Canplas Industries Ltd
 Canada: 1-800-461-5300 USA: 1-888-461-5307

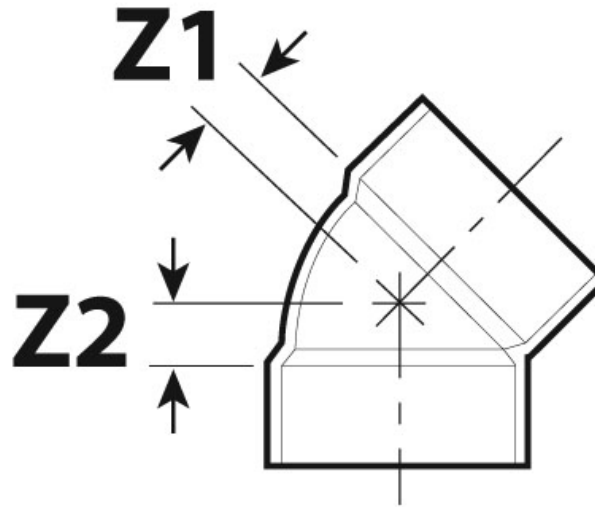

Part #	Part UPC	Colour	Size (inches)	Ctn Qty	Ctn Bar Code	Ctn. Wt (Kgs)	Ctn. Wt (lbs)	Skid Cubic (m)	Skid Cubic (ft)	Ctns/Skid
414186BC	662671410252	WHITE	6X6	10	20662671410256	9.57	21.05	1.90	67.04	18

Dimensions (inches)

Z1	Z2
1.42	1.44