



COOLER PARTS CATALOG



DIAL MANUFACTURING, INC.

Everything to Maintain Your Evaporative Cooler

1-800-350 DIAL

25 South 51st Avenue Phoenix, Arizona 85043 (602) 278-1100 (800) 350-DIAL Fax (602) 278-1991 Fax (800) 370-3299

www.dialmfg.com



EVAPORATIVE COOLER PARTS



WATER DISTRIBUTOR TUBES & CLIPS Pages 11 & 12

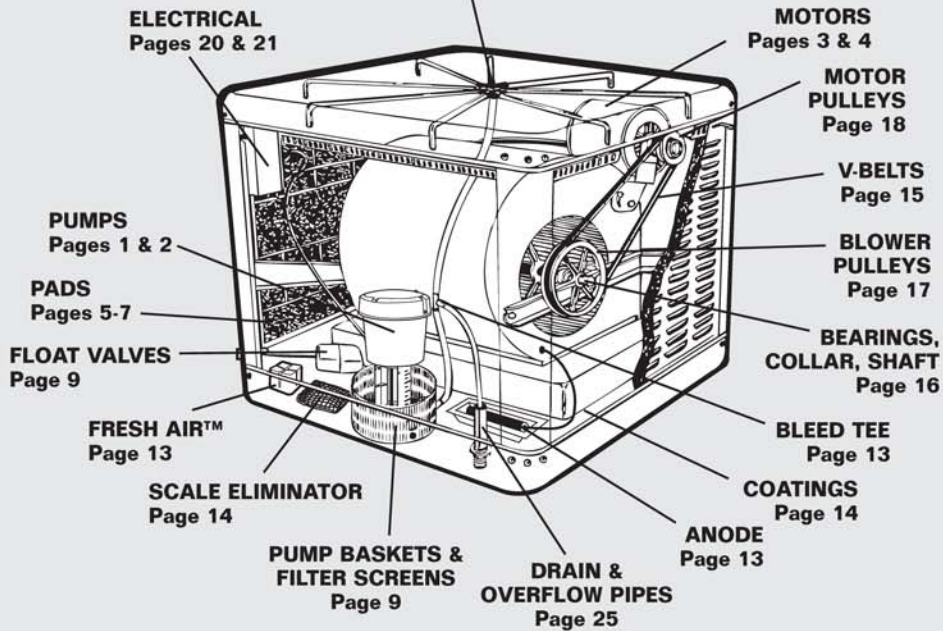

Digital Cooler Controller™

PN 7619

115 VOLTS

A fully automatic evaporative cooling controller with digital readout. Automatically controls cooler operation and temperature setting. Special "pad pre-wet" cycle adds cooling efficiency.



FEATURES

- Automatically turns cooler on/off at desired (programmed) temperature setting.
- Constant digital display of room temperature.
- Automatic four (4) minute pad pre-wet cycle.
- Green run indicator light comes on when unit is running.
- Compact, stylish, state-of-the-art design.
- Designed for use with 1/3, 1/2, 3/4, and 1 HP 2-speed, 115 volt motors.
- 80 degree power interruption default setting. Unit automatically resets to 80 degrees in the event of power failure.
- Mounts in either a standard single 2x4 or double 4x4 gang electrical box.
- Easy, worry-free operation.



DIAL MANUFACTURING, INC.
25 S. 51st Ave. • Phoenix, AZ 85043
(602) 278-1100 • www.dialmfg.com

EziStat™ CONTROLLER

PN 7621

115V / 230V

Automatic or Manual Operation

Changes motor speeds automatically and turns pump on and off.



FEATURES

- Automatically adjusts from high to low speed as temperature approaches set point.
- "Set and forget" option with soft touch buttons.
- Optional manual control for cool (pump) and fan only and 2 / 4 / 8 hour timer mode.
- Automatic start and stop.
- Simple 5 wire interface.
- Installs in standard 2 x 4 single gang electrical box.
- Designed for 1/3, 1/2, 3/4 and 1 HP 2-speed motors. 115V or 230V.
- Easy to install.
- Ultra slim profile.



DIAL MANUFACTURING, INC.
25 S. 51st Ave. • Phoenix, AZ 85043
(602) 278-1100 • www.dialmfg.com



HIGH EFFICIENCY CONCENTRIC PUMP

OPERATES IN WATER RESERVOIRS OF 1/2" TO 4" LOW DRAW / LOW RECOVERY

ONE YEAR WARRANTY

PUMP FLOW RATE PERFORMANCE

120 VAC, 60 HZ

GALLONS PER HOUR
1 FT. HEAD HEIGHT

EVAPORATIVE COOLER RETROFIT PUMP
FOR USE WITH SPECIFIED
EVAPORATIVE COOLERS ONLY
EK91

MADE IN U.S.A.

336 pumps per pallet

Dial P/N	Model	CFM / GPH @ 1 Ft.*	Volts	Color	Approval*	Ctn Qty.	Ctn Wt.
----------	-------	--------------------	-------	-------	-----------	----------	---------

RESIDENTIAL CONCENTRIC

<ul style="list-style-type: none"> UL Recognized Auto Reset Thermal Overload 			<ul style="list-style-type: none"> Flame Retardant Motor Housing Grounded 3 Prong Plug 			<ul style="list-style-type: none"> Heavy Duty Motor Low Level Pump 		
	▲1150	UL5500 Premium Pump	5,500 / 240	115V	Black	UL/UR	12 27.0	
	▲1175	UL7500 Premium Pump	7,500 / 360	115V	Blue	UL/UR	12 31.0	
	▲1195	UL11000 Premium Pump	11,000 / 420	115V	Green	UL/UR	12 36.8	
	▲1279	UL7500-2 Premium Pump	7,500 / 360	230V	Orange/Black	UL/UR	6 17.0	
	▲1286	UL11000-2 Premium Pump	11,000 / 420	230V	Orange/Black	UL/UR	6 19.2	

COMMERCIAL CONCENTRIC

<ul style="list-style-type: none"> UL Recognized & City Of L.A. Approved Auto Reset Thermal Overload Flame Retardant Motor Housing 			<ul style="list-style-type: none"> Molded 3 Prong Plug Grounded Round SJT Power Cord Extra Heavy Duty Motor 			<ul style="list-style-type: none"> Low Level Operation Low Level Splash Protection 		
	▲1414	UL7500LA Pump	7,500 / 375	115V	Black	UL/UR/ COLA	12 33.2	
	▲1424	UL11000LA Pump	11,000 / 440	115V	Black	UL/UR/ COLA	12 40.0	
	▲1428	UL7500-2LA Pump	7,500 / 375	230V	Orange/Black	UL/UR/ COLA	6 17.5	
	▲1429	UL11000-2LA Pump	11,000 / 440	230V	Orange/Black	UL/UR/ COLA	6 20.1	

INDUSTRIAL CONCENTRIC

<ul style="list-style-type: none"> Same Features As Commercial Pumps 			<ul style="list-style-type: none"> 6 Ft Grounded Round SJT Power Cord 			<ul style="list-style-type: none"> Requires 5/8 Or 3/4 Inch I.D.Pump Hose 		
	▲1387	UL15000LA Pump	12 to 21,000 / 505	115V	Black	UL/UR/ COLA	6 21.3	
	▲1400	UL25000LA Pump	15 to 25,000 / 580	115V	Black	UL/UR/ COLA	6 22.5	
	▲1396	UL15000-2LA Pump	12 to 21,000 / 505	230V	Orange/Black	UL/UR/ COLA	6 21.9	
	▲1402	UL25000-2LA Pump	15 to 25,000 / 580	230V	Orange/Black	UL/UR/ COLA	6 23.3	

MASTERCool® REPLACEMENT

<ul style="list-style-type: none"> Replacement Pumps For Mastercool® Using 8" And 12" Media And Arctic Circle® Coolers Includes Mesh Basket And Mounting Bracket 			<ul style="list-style-type: none"> Exceeds OEM Pump Performance And Longevity 				
	▲1442	MC8500UL Pump	4 to 8,500 / 360	115V	Tan	UL/UR	6 14.2
	▲1443	MC8500-2UL Pump	4 to 8,500 / 360	230V	Orange/Black	UL/UR	6 14.9

Fits Fits
 MasterCool® Arctic Circle®

*Gallons per hour flow rate at 1 foot.
 **UL Classified Replacement Pump, UL Recognized Component Pump and City Of Los Angeles Approved.



OFFSET PUMP

- FLAME RETARDANT MOTOR HOUSING
- PERMALUBE BEARINGS
- FITS CHAMPION™ COOLER MOUNTING BRACKET
- BUILT-IN BARBED ELBOW
- BUILT-IN SUPPLEMENTARY PUMP SCREEN
- AUTO RESET THERMAL OVERLOAD
- CORROSION RESISTANT SHAFT
- EXTRA LONG CORD
- THREE PRONG GROUNDED PLUG
- REMOVABLE BASE PLATE FOR EASE OF CLEANING

OPERATES IN WATER RESERVOIRS OF 1/2" TO 4" LOW DRAW

PUMP FLOW RATE PERFORMANCE

120 VAC, 60 HZ

GALLONS PER HOUR
1 FT. HEAD HEIGHT

290 UL10000	250 UL7000	225 UL5000
-----------------------	----------------------	----------------------

EVAPORATIVE COOLER RETROFIT PUMP
FOR USE WITH SPECIFIED
EVAPORATIVE COOLERS ONLY
6K91

90 DAY WARRANTY

336 pumps per pallet

Dial P/N	Model	CFM / GPH *	Volts	Color	Approval**	Ctn Qty	Ctn Wt	
OFFSET								
		<ul style="list-style-type: none"> Auto Reset Thermal Overload Flame Retardant Motor Housing 	<ul style="list-style-type: none"> Molded 3 Prong Plug & Grounded Cord Low Level Pump 		<ul style="list-style-type: none"> 90 Day Warranty Bilingual Packaging 			
▲1055	UL5000 Offset Pump	5,000 / 225	115V	Maroon	UL/UR	12	22.4	
▲1075	UL7000 Offset Pump	7,000 / 250	115V	Tan	UL/UR	12	25.0	
▲1095	UL10000 Offset Pump	10,000 / 290	115V	Gray	UL/UR	12	27.5	



OFFSET FOR MASTERCool®

		<ul style="list-style-type: none"> Built-In Optional Bleed-Off Port Auto Reset Thermal Overload Flame Retardant Motor Housing 	<ul style="list-style-type: none"> Heavy Duty Motor Molded 3 Prong Plug Grounded Power Cord 		<ul style="list-style-type: none"> Low Level/Low Recovery UL Classified And City Of L.A. Approved One Year Warranty/Made in U.S.A. 			
▲1438	UL 115V Pump for Single Inlet Coolers	8" Media/ 290	115V	Gray	UL/UR/COLA	6	27.5	
▲1440	UL 230V Pump for Single Inlet Coolers	8" Media/ 290	230V	Gray	UL/UR/COLA	6	27.6	



Recommended for MasterCool® EC 430/440, EC 630/640, IM 450/460, IM 650/660; AeroCool™ 4400/4800, ACD 5800/6800; UltraCool™ 4500/6500; ComfortCool™ SI 5000/7000.

MasterCool®, AeroCool™, UltraCool™, ComfortCool™ are trademarks of AdobeAir, Inc., Phoenix Manufacturing, Inc., Champion Cooler Corp. and Essick Air respectively.

*Gallons per hour flow rate at 1 foot.

**UL Classified Replacement Pump, UL Recognized Component Pump, and City Of Los Angeles Approved.



COOLER MOTORS



EVAPORATIVE COOLER MOTORS

High Temperature Insulation System
Capable of withstanding temperatures over 300° F, this system reduces motor failures due to heat aging.

Underwriter's Laboratories Approved Construction
Mechanically and electrically approved for evaporative cooler applications

Premium Moisture Resistant Insulation System
Tests prove that in high moisture applications, this system has twice the life of the nearest competitor.

Styrenated Epoxy Coating on Rotor
This chromate free treatment prevents rust build-up and extends the life of the motor.



Heavy Duty Bronze Bearing
5/8" diameter fed by an extra large reservoir of oil; insures long life.

Superior Starting Switch Features
Rust inhibiting materials and coatings provide increased motor life.

High Viscosity Encapsulating Varnish
Reduces winding failures, and increases resistance to moisture.

Automatic Reset Thermal Overload Protection
This Underwriter's Laboratories listed protector helps to prevent motor burnouts due to temporary overloads.

Permanently Lubricated Sleeve Bearings
Motor is permanently lubricated at the factory; no relubrication is required.



LABEL AND INSTRUCTIONS IN ENGLISH AND SPANISH

- All Copper*
- High Efficiency
- Single Phase

100 Motors Per Pallet

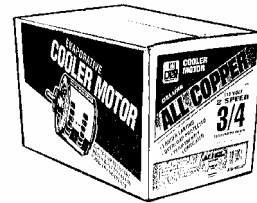

	Dial P/N	Model	Volts	Amp Rating	Shaft Dia.	Ctn Wt	Ctn Qty
--	----------	-------	-------	------------	------------	--------	---------

COPPERLINE™ REPLACEMENT MOTOR

ALL COPPER WINDINGS – 56Z FRAME MOTOR ONLY, NO BASE



▲2201	1/3 HP 1 Speed Motor	115V	6.3	1/2"	12.6	1
▲2202	1/3 HP 2 Speed Motor	115V	6.5	1/2"	14.2	1
▲2203	1/2 HP 1 Speed Motor	115V	7.6	1/2"	13.8	1
▲2204	1/2 HP 2 Speed Motor	115V	8.4	1/2"	17.0	1
▲2205	3/4 HP 1 Speed Motor	115V	10.5	1/2"	15.4	1
▲2206	3/4 HP 2 Speed Motor	115V	10.5	1/2"	20.6	1

COPPERLINE™ SINGLE INLET REPLACEMENT MOTOR

WILL FIT MASTER COOL®, AERO COOL™, AND ULTRA COOL™ - ALL COPPER – MOTOR ONLY, NO BASE



▲2395	1 HP 2 Speed Single Inlet Motor	115V	12.3	5/8"	26.1	1
▲2396	1 HP 2 Speed Single Inlet Motor	230V	6.2	5/8"	25.1	1

230 VOLT COOLER MOTOR

COMPOSITE WINDINGS – 56Z FRAME MOTOR ONLY, NO BASE



▲2172	1/2 HP 1 Speed Motor	230V	4.4	1/2"	14.5	1
▲2176	1/2 HP 2 Speed Motor	230V	4.4	1/2"	16.3	1
▲2184	3/4 HP 1 Speed Motor	230V	5.1	1/2"	17.7	1
▲2189	3/4 HP 2 Speed Motor	230V	5.1	1/2"	20.4	1

INDUSTRIAL COOLER MOTOR

INCLUDES BASE AND CLAMPS



▲2390	1 HP 2 Speed Motor	115V	12.3	5/8"	28.5	1
▲2391	1 HP 1 Speed Motor	115/ 230V	15.8	5/8"	26.5	1
▲2392	1 HP 2 Speed Motor	230V	6.2	5/8"	33.0	1

Copperline™, MasterCool®, Arctic Circle® and WisperCool®; AeroCool™, Phoenix™ and Frigiking™; Champion™ and UltraCool™ are trademarks of Dial Manufacturing, Inc., AdobeAir, Inc., Phoenix Manufacturing, Inc. and Essick Air Products, Inc., respectively.
*230V motors have copper / aluminum composite windings



MOTOR KITS & PARTS

EVAPORATIVE COOLER MOTORS

COPPERLINE™ SINGLE INLET MOTOR KITS WITH MINI PLUGS

WITH SPECIAL MINI PLUG AND CORD, ADJUSTABLE IRON PULLEY, AND MOTOR CLAMPS - WILL FIT MASTER COOL®

Dial P/N	Model	Volts	Amp Rating	Pulley Size	Ctn Wt	Ctn Qty
▲2574	1/2 HP 2 Speed Motor Kit W/Mini Plug	115V	8.4	3½ x ½	17.9	1
▲2576	3/4 HP 2 Speed Motor Kit W/Mini Plug	115V	10.5	3¾ x ½	21.9	1
▲2577	1 HP 2 Speed Motor Kit W/Mini Plug	115V	12.3	4 x ⅝	27.9	1
▲2578	1 HP 2 Speed Motor Kit W/Mini Plug	230V	6.2	4 x ⅝	27.8	1



1 HP MOTOR KIT

COPPERLINE™ MOTOR KITS

WITH 36" MOTOR CORD, ADJUSTABLE IRON PULLEY, AND MOTOR CLAMPS - C.O.L.A. APPROVED
WILL FIT ARCTIC CIRCLE®, WISPER COOL®, PHOENIX™, FRIGIKING™, AERO COOL™, ULTRA COOL™

Dial P/N	Model	Volts	Amp Rating	Pulley Size	Ctn Wt	Ctn Qty
▲2530	1/3 HP 1 Speed Motor Kit	115V	6.3	3¼ x ½	13.7	1
▲2537	1/3 HP 2 Speed Motor Kit	115V	6.5	3¼ x ½	15.5	1
▲2545	1/2 HP 1 Speed Motor Kit	115V	7.6	3½ x ½	15.2	1
▲2548	1/2 HP 2 Speed Motor Kit	115V	8.4	3½ x ½	18.6	1
▲2564	3/4 HP 1 Speed Motor Kit	115V	10.5	3¾ x ½	18.1	1
▲2569	3/4 HP 2 Speed Motor Kit	115V	10.5	3¾ x ½	22.5	1
▲2393	1 HP 2 Speed Motor Kit for Aero/UltraCool	115V	12.3	4 x ⅝	27.5	1
▲2394	1 HP 2 Speed Motor Kit for Aero/UltraCool	230V	6.2	4 x ⅝	27.1	1



1/3 - 3/4 HP MOTOR KIT

MOTOR ACCESSORIES

Dial P/N	Description – Packaging	Pkg	Ctn Qty	Ctn Wt.
▲2710	Motor Clamps (set of 2)	Bag	10	1.0
▲27105	Motor Clamps (set of 2)	Bag	50	5.5
▲2715	Motor Clamps (set of 2)	Clam	10	1.1
▲2724	Motor Base	Lbl	6	9.6
▲2726	Motor Base for A.O. Smith 1HP	Lbl	6	10.0
2731	Belt/Motor Tension Adjuster	Blk	10	1.8
▲2736	Belt/Motor Tension Adjuster	Clam	6	1.4
▲2739	3/16" x 3/16" x 1-1/2" Motor Shaft Key	Clam	10	0.2
2742	1/2" x 5/8" Motor Pulley Adapter	Blk	10	0.5
▲2748	1/2" x 5/8" Motor Pulley Adapter	Clam	8	0.5
▲2828	2 Speed Motor Relay Switch - 115V	Pkg	4	4.3
2835	A.O. Smith Motor Mounting Ring	Blk	10	0.9



Motor Clamps



1/3 to 3/4 HP Motor Base



AOS 1HP Motor Base

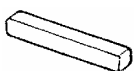

Motor Shaft Key



Motor Pulley Adapter



A.O. Smith Motor Mounting Ring



2 Speed Relay Switch



Belt Tension Adjuster

COOLER PADS & ROLLS



DURA-COOL™ EVAPORATIVE COOLER PAD

THE MOST ADVANCED COOLER PAD

- COOLER AIR... MORE EFFICIENT
- REMOVES PARTICULATES
- NON-ALLERGENIC... ODORLESS
- WON'T SHED FIBER

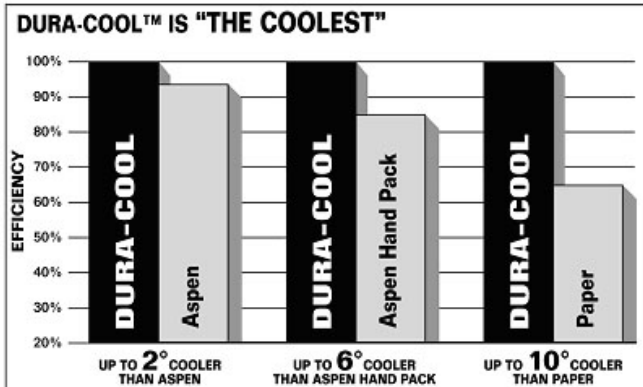

NOTE: Data generated at Dial Manufacturing's Engineering Laboratory under identical conditions.

Dial P/N	Model / Size	Cut To Fit	Pkg	Ctn Wt	Ctn Qty
----------	--------------	------------	-----	--------	---------

DURA-COOL™ PRE-CUT PADS

HIGH EFFICIENCY FOAMED POLYESTER - MORE EFFICIENT THAN PAPER PADS

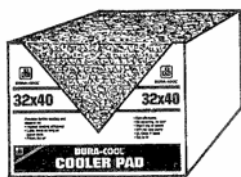

▲3060	19 x 36 Dura-Cool Pad**	Tradewinds TC-451	Lbl	14.5	24
▲3070	24 x 30 Dura-Cool Pad**	24 x 24	Lbl	14.5	24
▲3069	24 x 36 Dura-Cool Pad**	22 x 34	Lbl	18.0	24
▲3062	24 x 40 Dura-Cool Pad**	Tradewinds TC-571	Lbl	20.0	24
▲3063	25 x 33 Dura-Cool Pad**	Tradewinds TS-451	Lbl	15.0	24
▲3071	28 x 32 Dura-Cool Pad**		Lbl	19.0	24
▲3072	28 x 34 Dura-Cool Pad**	28 x 32	Lbl	19.5	24
▲3073	29 x 30 Dura-Cool Pad**	29 x 29	Lbl	18.0	24
▲3074	30 x 36 Dura-Cool Pad**	28 x 34	Lbl	21.5	24
▲3075	32 x 40 Dura-Cool Pad**	32 x 35	Lbl	25.5	24

DURA-COOL™ ROLLS CUT TO FIT

HIGH EFFICIENCY FOAMED POLYESTER - MORE EFFICIENT THAN PAPER PADS



▲3078	4500 CFM Dura-Cool Roll**	29 x 144	Pkg	26.0	5
▲3079	6500 CFM Dura-Cool Roll**	33 x 160	Pkg	32.0	5
▲3080	36 x 240 Dura-Cool Roll**	20 Ft.	Pkg	37.0	5
▲3095	36 x 576 Dura-Cool Roll**	48 Ft.	Lbl	15.0	1

Note: **Items do not qualify for UPS shipping.

AIR FILTER UNIT
CLASSIFIED BY
UNDERWRITERS LABORATORIES
AS TO FLAMMABILITY ONLY
CLASS 2
419S-R7568



COOLER PADS



ASPEN PADS

Individually packaged aspen pads made with rugged natural super absorbent aspen – biodegradable. Expands to extra thick when wetted. Aspen fibers are evenly distributed for a uniform cooling surface and interwoven to avoid sagging. Aspen pads are more efficient than paper pads producing a lower cooling temperature. Fold to fit...do not cut.

Dial P/N	Model / Size	Fold To Fit	Pallet Qty.	Master Pack	Bundle Wt	Bundle Qty
----------	--------------	-------------	-------------	-------------	-----------	------------

ASPEN PADS

INDIVIDUALLY PACKAGED

▲3006	20 x 22 Aspen Pad	18 x 22	1152	144	26.0	24
▲3004	20 x 36 Aspen Pad	Tradewinds TC-451	576	144	40.0	24
▲3007	22 x 24 Aspen Pad	20 x 21, 20 x 22 and 21 x 24	1152	144	32.9	24
▲3002	22 x 34 Aspen Pad	18 x 29 and 22 x 30	576	144	44.0	24
▲3045	24 x 24 Aspen Pad	22 x 24	1152	144	34.0	24
▲3044	24 x 26 Aspen Pad	22 x 24, 22 x 26 and 24 x 24	1152	144	35.0	24
▲3003	24 x 30 Aspen Pad	21 x 29	576	144	43.0	24
▲3005	24 x 36 Aspen Pad	22 x 34 and 20 x 36	576	144	51.0	24
▲3011	24 x 42 Aspen Pad	Tradewinds TC-571	576	144	55.0	24
▲3048	26 x 34 Aspen Pad	Tradewinds TS-451	432	144	42.0	24
▲3012	28 x 32 Aspen Pad	26 x 30	432	144	56.0	24
▲3001	28 x 34 Aspen Pad	26 x 34 and 28 x 32	432	144	56.0	24
▲3046	29 x 29 Aspen Pad	28 x 29	432	144	49.0	24
▲3008	30 x 36 Aspen Pad	30 x 35	288	72	63.0	12*
▲3030	32 x 40 Aspen Pad	26 x 40	216	72	37.0	12*
▲3024	33 x 36 Aspen Pad	30 x 36 and 32 x 35	288	72	35.0	12*
▲3015	36 x 42 Aspen Pad	36 x 36	216	72	44.0	12*
4012	"Pad Size" Display Labels Kit - for 12 Most Popular Sizes					1

*Pads are folded for shipping.

ASPEN SPIN ROLLS

24 FT. ROLLS – CUT LENGTHWISE TO FIT

3404	20 x 288 Aspen Roll	13.0	1
3409	24 x 288 Aspen Roll	16.0	1
3410	28 x 288 Aspen Roll	18.0	1
3411	30 x 288 Aspen Roll	19.0	1
3412	36 x 288 Aspen Roll	23.0	1
3413	48 x 288 Aspen Roll	31.0	1



RIGID COOLING MEDIA



THE ULTIMATE COOLING MEDIA FOR SINGLE INLET EVAPORATIVE COOLERS

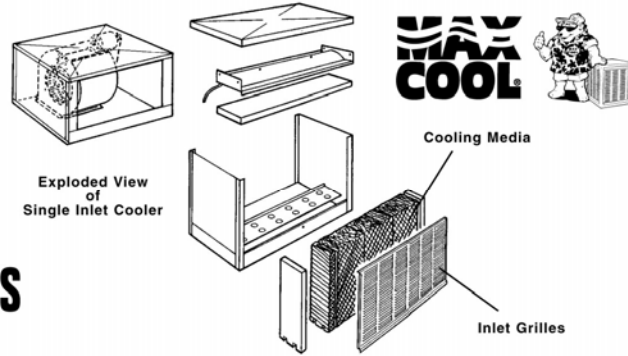

RIGID COOLING MEDIA

- Long Life
- High Air Velocity
- Energy Efficient
- Consistent Performance
- Heavier paper holds more water and lasts longer
- Fast wet-out
- Limited one-year warranty

• Engineered for optimal performance and longevity... Cellulose base impregnated with plastic resins and anti-rot agents... Durable and easy to install.

8" RIGID MEDIA	Dial PN	Description	Pkg.....Box / Ctn Qty.....1	
			W x H x D	Ctn Wt
	▲3437	8" MasterCool PM100/ AeroCool 4800 CFM (Grooved)	40 x 23 x 8	10.0
	▲3438	8" MasterCool PM200 6800 CFM (Grooved)	40 x 28 x 8	12.0
	▲3439	8" AeroCool 6800CFM	40 x 30 x 8	13.5
	▲3440	8" UltraCool ADA/ASA 50 and 51 / ComfortCool SI500	41¼ x 22¼ x 8	11.0
	▲3441	8" UltraCool ADA/ASA 70 and 71 / ComfortCool SI700	41¼ x 28¾ x 8	13.5
	▲3442	8" Champion UltraCool™ ASA/ADA 50 Pad	41¼ x 21-7/8 x 8	
	▲3443	8" Champion UltraCool™ ASA/ADA 70 Pad	41½ x 28-3/8 x 8	
	▲3460*	8" Industrial MasterCool PM300 (Grooved)	40 x 37¼ x 8	18.5
	▲3461*	8" Industrial MasterCool PM400/AeroCool (Grooved)	48 x 44-5/8 x 8	24.8

Engineered for optimal performance and longevity... Cellulose base impregnated with plastic resins and anti-rot agents... Durable and easy to install.

12" RIGID MEDIA	Dial PN	Description	Pkg.....Box / Ctn Qty.....1	
			W x H x D	Ctn Wt
	▲3452*	12" MasterCool PM120/AeroCool 45/48 (Grooved)	40 x 23 x 12	16.0
	▲3453*	12" MasterCool PM220 (Grooved)	40 x 28 x 12	19.0
	▲3454	12" AeroCool 6800 CFM	40 x 30 x 12	20.2
	▲3455	12" UltraCool ADA/ASA 5012 and 5112	41¼ x 22¼ x 12	16.5
	▲3456	12" UltraCool ASDA/ASA 7012 and 7112	41¼ x 28¾ x 12	19.5
	▲3465*	12" Industrial MasterCool PM500/AeroCool (Grooved)	48 x 44-5/8 x 12	38.0

- Long Life
- High Air Velocity
- Energy Efficient
- Long Life

3" MASTERCool® WINDOW VIEW RIGID MEDIA (4 pcs)	Dial PN	Description	Pkg.....Box / Ctn Qty.....1	
			W x H x D	Ctn Wt
	▲3436	3" MasterCool MW5500 Window View Pad (4 pcs)	10 x 26-1/8 x 3	10.0

3-1/2" BREEZAir™ RIGID MEDIA (4 pcs)	Dial PN	Description	Pkg.....Box / Ctn Qty.....1	
			W x H x D	Ctn Wt
	▲3431	3½" BreezAir™ EM-1 (4 pcs)	17½ x 31½ x 3½	11.0
	▲3432	3½" BreezAir™ EM-2 (4 pcs)	25 x 31½ x 3½	13.0

*Oversize carton dimensions prevent UPS shipment of PN's 3460, 3461 and 3465.

Note: Styrofoam spacers are not included.

MasterCool®, AeroCool™, UltraCool™, ComfortCool™ are trademarks of AdobeAir, Inc., Phoenix Manufacturing, Inc., Champion Cooler Corp. and Essick Air respectively. Max-Cool® is a registered trademark of Dial Manufacturing, Inc. BreezAir™ is a trademark of Seeley International.

AUTOMATIC EVAPORATIVE COOLER PURGE SYSTEM



**INSTALLS
IN MINUTES!**



AUTOMATICALLY FLUSHES YOUR COOLER EVERY 8 HOURS

REPLACES CLEAN MACHINE® AND PMI AUTOMATIC COOLER CLEANER® AND FOR NEW PURGE PUMP INSTALLATIONS

Changes cooler water every 8 hours of operation

Every 8 hours of cooler operation, the Power-Clean® drain pump activates to remove the old cooler reservoir water. The cooler is then refilled with fresh water.

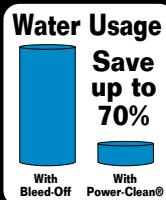

- Saves water and money
- Reduces maintenance
- Freshens air
- Pads last longer
- Prevents mineral buildup

The best way to keep your cooler clean has always been to install a "bleed-off" system which drains off a percentage of water while the cooler is in operation.

Now you can replace the "bleed-off" with a system that can save as much as 3000 gallons of water per month. That is a lot of water in a season.

Power-Clean® will save money and conserve water by automatically flushing your cooler clean every 8 hours.

POWER-CLEAN®

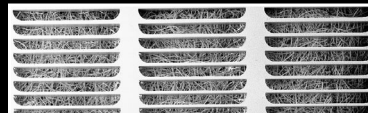

WITHOUT **POWER-CLEAN®**

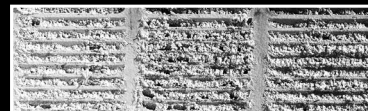

AUTOMATIC POWER-CLEAN®

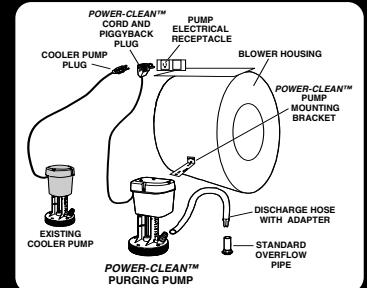

Once installed in the pan of the cooler, Power-Clean® automatically cycles every 8 hours of cooler operation to empty the water and replenish the cooler with fresh water.

The cooling capability is never interrupted. Replacing the cooler water on a regular basis is beneficial by removing mineral scale build-up and bacterial growth. Power-Clean® eliminates the need for a bleed-off and the use of cleaners and harsh chemical additives.

Power-Clean® includes...

- Purge pump
- Mesh pump screen
- Mounting bracket
- Installation instructions
- 30 inches of 1/2 inch I.D. vinyl drain hose
- Drain hose to overflow pipe adapter

Part No.	Description	Amp Rating*	Pkg.	Carton Qty.	Carton Wt.
▲ 1540	115V Power-Clean® Kit — Complete kit for all cooler models	0.7	Box	6	16.0
▲ 1542	230V Power-Clean® Kit — Complete kit for all cooler models	0.4	Box	6	16.0



PN 1552

▲ 1552	Purge Pump Drain Adapter — Adapter only	—	Clam	6	0.2
▲ 1554	Purge Pump Drain Kit and Adapter	—	Clam	6	0.8

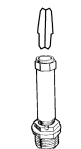

PN 1554

FITS ALL EVAPORATIVE COOLERS

TWO YEAR WARRANTY

*In Tucson, Arizona; a 1.6 amp pump fuse may be required for Power-Clean® operation.

Power-Clean® is manufactured by Dial Manufacturing, Inc. under license from Phoenix Manufacturing, Inc. and is protected by US Patent 5,527,157.



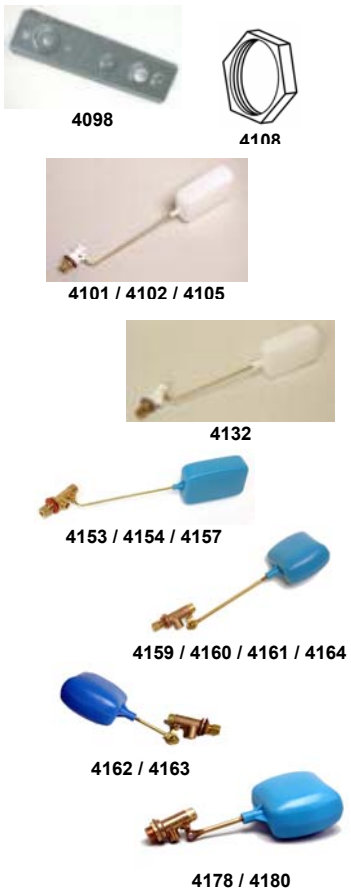
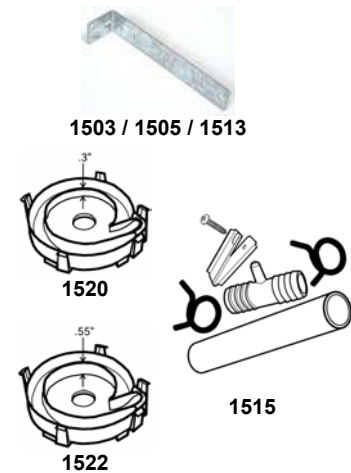

Dial P/N	Description/Packaging	Pkg	Ctn Qty	Ctn Wt	
PUMP MOUNTING BRACKETS					
1503	Metal Pump Mounting Bracket	Universal brackets fit all pump models.	Bulk	10	0.2
▲1505	Metal Pump Mounting Bracket		Clam	10	0.3
▲1513	MasterCool/Arctic Pump Bracket		Clam	10	0.3
▲1515	Pump Elbow Extension Kit	Fits MasterCool® and Arctic Circle® and all other pump brands.	Clam	10	0.3
▲1515	Pump Elbow Extension Kit	<i>INCLUDES:</i> 3" Pump hose, 2 pump hose clamps, bleed tee and bleed tee cap. For use with MasterCool and other coolers requiring extra pump hose length and/or an above water level bleed tee installation/	Bag	10	0.4
▲1520	5000 Pump Base	Replacement base for Concentric 5500 CFM pump and PowerClean pump models (0.3" volute cavity depth)	Clam	6	0.3
▲1522	7000 / 11000 Pump Base	Replacement base for Concentric 7500, 11000, 15000 and 25000 CFM pump models (0.55" volute cavity depth)	Clam	6	0.3

MasterCool® and Arctic Circle® are registered trademarks of AdobeAir, Inc.

Dial P/N	Description/Packaging	Pkg	Ctn Qty	Ctn Wt	
PUMP SCREENS AND FILTERS					
4215	Plastic Pump Basket	Heavy duty formed basket side and bottom. Rugged Polyethylene 8" long, 6" wide and 3-1/2" high...fits all pump models.	Bulk	50	6.0
▲4218	Plastic Pump Basket		Label	12	1.9
4220	Mesh Pump Basket		Bulk	50	4.0
▲4221	Mesh Pump Basket	Poly mesh basket. OEM style fits all offset and concentric pumps.	Label	120	12.0
▲4222	Mesh Pump Basket		Label	12	1.0
▲42225	Mesh Pump Basket		Label	24	2.0
4235	Pump Screen	Adjustable screen designed to fit all pump models. Easy to install. Rugged Polyethylene.	Bulk	50	6.5
▲4238	Pump Screen		Label	24	3.4
▲4253	Pump Micro Filter	Eliminates fine media from entering water distribution system. For use with pump screen only. Easy to install.	Bag	10	0.7

Dial P/N	Description/Packaging	Pkg	Ctn Qty	Ctn Wt	
FLOAT VALVES					
▲4098	Float Valve Mounting Bracket	Galvanized steel. Fits all floats	Label	10	1.7
4108	1/4" Float Valve Locknut	Replacement for all 1/4" Float Valves	Bulk	10	0.9
▲4101	1/4" Float Valve (White)	1/4" compression - Brass inlet, arm and stem. Polypropylene body and float. Noiseless and noncorrosive.	Label	10*	1.6
▲4102	1/4" Float Valve (White)		Label	50	7.7
▲4105	1/4" Float Valve (White)		Clam	10	2.2
▲4132	1/4" Celcon Float Valve (White)	1/4" compression - Brass inlet, arm and stem. Rugged Celcon body. Poly-propylene float. Extra shut off capacity.	Label	10	1.9
▲4154	1/4" Brass Float Valve (Blue)	1/4" compression - Brass body casting, brass arm and stem. Stainless steel seat. Polypropylene float. Plunger rotates to discourage alkali deposits.	Label	50	11.9
▲4153	1/4" Brass Float Valve (Blue)		Label	10*	2.5
▲4157	1/4" Brass Float Valve (Blue)		Clam	10	3.1
▲4159	1/4" Heavy Duty Bronze Float Valve** (Green)	1/4" compression - Heavy duty bronze body, brass plunger, arm and stem. Polypropylene float. 2 piece arm with adjustable screw. Bronze is resistant to corrosion.	Label	10*	4.1
▲4160	1/4" Heavy Duty Bronze Float Valve** (Green)		Clam	10	5.4
▲4161	1/4" Heavy Duty Bronze Float Valve** (Green)		Label	30	19.5
▲4162	1/4" Tradewinds Bronze Float Valve - 3" Arm** (Green)	Same as above except with shorter 3" brass arm.	Label	10	4.0
▲4163	1/4" Tradewinds Bronze Float Valve - 3" Arm** (Green)		Label	30	12.0
▲4164	3/8" Heavy Duty Bronze Float Valve (Red)	3/8" compression for industrial coolers. Heavy duty bronze body, brass plunger, arm and stem. Polypropylene float. 2 piece arm with adjustable screw.	Label	10	4.1
▲4178	3/8" MPT and 1/8" FPT Bronze Float Valve (Red)	3/8" MPT threads and 1/8" FPT threads. Heavy duty Bronze body, brass plunger and 2 piece arm for residential and industrial coolers, fountain and stock tanks.	Label	10	4.3
▲4180	3/8" MPT and 1/8" FPT Bronze Float Valve - 3" Arm (Black)	Same as 4178, except with shorter 3" Brass arm. For industrial coolers, swimming pools, fountains and stock tanks.	Label	10	5.2

*10 per carton — 10 boxes per master carton.

**For Tradewinds and Aireze coolers with thick plastic walls.

▲UPC Items



EVAPORATIVE COOLER PARTS

TUBING

Dial P/N	Description	Pkg.	Carton Qty.	Carton Wt.
----------	-------------	------	-------------	------------

POLY TUBING

For **Outdoor** Use Only. Do not use indoors or in attic.

Natural, Copper and Black — 1/4" O.D. — Use to Run Water to Coolers (not for potable water)

▲4288	1/4" 25 Ft. Copper Poly Tube	Label	10	3.9
▲4294	1/4" 50 Ft. Natural Poly Tube	Label	20	12.9
▲4296	1/4" 50 Ft. Black Poly Tube	Label	20	12.9
▲4299	1/4" 50 Ft. Copper Poly Tube	Label	20	12.9
▲4310	1/4" 100 Ft. Natural Poly Tube	Label	20	23.9
▲4316	1/4" 100 Ft. Copper Poly Tube	Label	20	23.9
▲4321	1/4" 100 Ft. Black Poly Tube	Label	20	23.9
▲4323	1/4" 1000 Ft. Natural Poly Tube	Box	1	12.3
▲4325	1/4" 1000 Ft. Black Poly Tube	Box	1	12.3

Copper and Black poly tubing are resistant to UV degradation.



POLY



COPPER

COPPER TUBING

Not recommended for refrigerations lines

Utility — .020 Wall — 1/4" O.D. — Use to Run Water to Coolers, Ice Makers, Humidifiers

▲4352	1/4" 25 Ft. Copper Tube	Pkg	10	14.2
▲4355	1/4" 50 Ft. Copper Tube	Pkg	10	29.0
▲4361	3/8" 50 Ft. Copper Tube	Pkg	10	50.5



MINI TUBE CUTTER

COPPER TUBE CUTTER

Cuts Copper, Brass and Steel Pipe

4335	Metal Tube Cutter	Cuts 1/8" to 1-1/8" tube	Bulk	10	4.4
▲4336	Metal Tube Cutter		Clam	6	2.8
▲4349	Mini Metal Tube Cutter	Cuts 1/8" to 5/8" tube	Bag	10	2.5
▲43495	Mini Metal Tube Cutter		Bag	20	5.0
▲4350	Mini Metal Tube Cutter		Clam	6	1.5

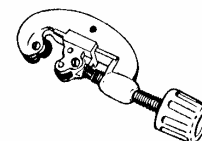

TUBE CUTTER

TUBE STRAPS

Metal Straps for 1/4" and 3/8" O.D. Poly or Copper Tube - Use to Support Water Line

9062	1/4" Metal Tube Strap	Bulk	50	0.4
▲9063	1/4" Metal Tube Strap (4 per bag)	Bag	10	0.2
▲9064	1/4" Metal Tube Strap (4 per card)	Clam	10	0.3
9067	3/8" Metal Tube Strap	Bulk	10	0.1



TUBE STRAP

VINYL PUMP HOSE

1/2, 5/8 and 3/4 In. I.D. — Clear Pump Hose — Use to Run Water from Pump to Distributor

▲4372	1/2" 5 Ft. Vinyl Pump Hose	Label	10	2.7
4378	1/2" 100 Ft. Vinyl Pump Hose	Bulk	4	23.0
▲4388	5/8" 6 Ft. Vinyl Pump Hose	Label	4	3.5
▲4396	3/4" 6 Ft. Vinyl Pump Hose	Label	4	3.8



VINYL

1/2 inch Pump Hose is standard for Residential and Commercial pumps with 4,500 to 11,000 CFM ratings...5/8 inch pump hose is required for Industrial pumps with 15,000 and 21,000 CFM rating...3/4 inch pump hose is required for Industrial pumps with 25,000 CFM rating.



PUMP INSTALLATION KIT

Dial P/N	Description	Pkg.	Carton Qty.	Carton Wt.
PUMP INSTALLATION KITS				
EVERYTHING TO INSTALL A PUMP ON A NEW OR EXISTING EVAPORATIVE COOLER				
PN4403 Includes: • 1/4" Float Valve • Water Distributor Adapter • 1/2" 5 Ft. Pump Hose • Pump Hose Restrictor • Pump Screen • 2 Hose Ring Clamps • Plastic Drain & Overflow Pipe • Instructions				
PN4405 Includes: • Same as PN4403, except with a Round Formed Basket instead of a Pump Screen.				
▲4403	Pump Installation Start-Up Kit	Bag	10	6.5
▲4405	Pump Installation Start-Up Kit	Pkg	10	8.2



**4472/4475
WATER HOOK-UP KIT**

Dial P/N	Description	Pkg.	Carton Qty.	Carton Wt.
WATER HOOK UP KITS				
EVERYTHING TO RUN WATER TO AN EVAPORATIVE COOLER				
POLY TUBE SILL COCK KITS PN 4472 AND 4475 outdoor use only:				
• 1/4" 25 Ft. Poly Tube • Brass Sill Cock - Garden Hose Thread x 1/8" FPT Tapped on Side • Hose Washer • 1/4"cc x 1/8" MPT Male Union • 1/4" Poly Tube Adapters (2) • Installation Instructions				
▲4472	Water Hook-Up Kit w/Poly Tube	Bag	10	9.0
▲4475	Water Hook-Up Kit w/ Poly Tube	Clam	10	9.7
POLY TUBE ANGLE VALVE SILL COCK KIT P/N 4479 outdoor use only:				
• 1/4" 25 Ft. Poly Tube • Brass Sill Cock - Garden Hose Thread x 1/8" FPT Tapped on Side • Hose Washer • 1/4"cc x 1/8" MPT Angle Needle Valve • 1/4" Poly Tube Adapters (2) • Installation Instructions				
▲4479	Water Hook-Up Kit w/Angle Needle Valve	Clam	10	9.9
COPPER TUBE SILL COCK KIT P/N 4487 outdoor use only:				
• 1/4" 25 Ft. Copper Tube • Brass Sill Cock - Garden Hose Thread x 1/8" FPT Tapped on Side • Hose Washer • 1/4"cc x 1/8" MPT Angle Needle Valve • Installation Instructions				
▲4487	Water Hook-Up Kit w/Copper Tube	Pkg	10	20.1



**4479/4487
WATER HOOK-UP KIT**



WATER DISTRIBUTOR KIT

Dial P/N	Description	Pkg.	Carton Qty.	Carton Wt.
WATER DISTRIBUTOR KITS				
Includes: • Distributor Tubes • Distributor Head • Water Distributor Adapter • MEK Solvent • Instructions				
▲4489	3 Way Side Draft Distributor Kit	Bag	8	2.8
▲4491	4 Way Side Draft Distributor Kit	Bag	8	3.1
▲4493	6 Way Side Draft Distributor Kit	Bag	12	5.2
▲4497	4 Way Down Draft Distributor Kit	Bag	8	3.4
▲4501	8 Way Down Draft Distributor Kit	Bag	12	6.4
One kit fits 3 way side, 4 way down, 6 way side and 8 way down by using an 8 way down distributor with up to 5 insert plugs & MEK				
▲4502	Universal Distributor Kit	Bag	12	8.0
▲4648	20-1/8" Distributor Tubes (4 per bag)	Bag	10	3.3
▲4777	Universal Distributor Head Kit (w/o tubes)	Clam	10	1.5
▲4779	Distributor Insert Plug (Use MEK to attach)	Blk	50	0.02
▲4780	Distributor Insert Plug (5 per card) to attach	Clam	10	0.02



UNIVERSAL HEAD KIT



EVAPORATIVE COOLER PARTS

SPIDER PARTS

Dial P/N	Description/Packaging	Pkg	Ctn. Qty.	Ctn. Wt.
WATER DISTRIBUTOR ACCESSORIES				
4621	Water Distributor Adapter	Bulk	50	0.6
▲4619	Water Distributor Adapter	Bag	10	0.2
▲4625	Water Distributor Adapter	Clam	8	0.2
4630	Tube Retainer Clip	Bulk	50	0.4
▲4631	Tube Retainer Clip (4 per)	Bag	10	0.4
▲46315	Tube Retainer Clip (4 per)	Bag	30	0.8
▲4632	Tube Retainer Clip (4 per)	Clam	10	0.4
4626	Champion Tube Retainer Clip	Bulk	50	0.4
▲4628	Champion Tube Retainer Clip (4 per)	Bag	10	0.4
▲46285	Champion Tube Retainer Clip (4 per)	Bag	30	0.8
▲4627	Champion Tube Retainer Clip (4 per)	Clam	10	0.4
4624	Tradewinds Distr. Tube Latch	Bulk	10	0.1
▲4622	Tradewinds Dist. Tube Latch (4 per)	Clam	10	0.5
4637	18-1/2" Distributor Tube	Bulk	100	6.1
4638	20-1/8" Distributor Tube	Bulk	100	6.4
▲4643	20-1/8" Distributor Tube	Box	200	12.4
▲4648	20-1/8" Distributor Tube (4 per)	Bag	10	3.3
4674	MEK Distributor Tube Solvent	Bulk	10	0.6
▲46745	MEK Distributor Tube Solvent	Bulk	25	1.2
▲4689	MEK Distributor Tube Solvent	Clam	6	0.4
▲4690	24" Spider Snake™	Label	10	0.9
▲4691	24" Spider Snake™	Clam	10	1.1
▲4693	60" Pump Hose and Water Distributor Snake	Label	10	1.2
▲4694	60" Pump Hose and Water Distributor Snake	Clam	10	1.3
4657	Tube Flow Meter - One Piece	Bulk	50	0.4
4663	2 Way Flow Divider	Bulk	10	2.3
4662	13/64 ID Meter Tip	Bulk	10	0.1



ADAPTER



TUBE



ADOBE CLIP



CHAMPION CLIP



TRADEWINDS DIST.



FLOW METER



SPIDER SNAKE



MEK



METER TIP

WATER DISTRIBUTOR HEADS

4713	3 Way Side Distributor Head	Bulk	12	0.4
▲4718	3 Way Side Distributor Head	Clam	12	0.5
4724	4 Way Side Distributor Head	Bulk	12	0.5
▲4729	4 Way Side Distributor Head	Clam	12	0.5
4732	6 Way Side Distributor Head	Bulk	12	0.5
▲4737	6 Way Side Distributor Head	Clam	12	0.5
4754	4 Way Down Distributor Head	Bulk	12	0.5
▲4759	4 Way Down Distributor Head	Clam	12	0.7
4770	8 Way Down Distributor Head	Bulk	12	0.6
▲4775	8 Way Down Distributor Head	Clam	12	0.7
4714	Distributor Head Screw	Bulk	12	0.1

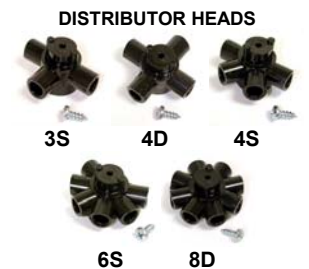

3S

4D

4S

6S

8D



PAD LATCH



DRIP TRAY

CHAMPION™ WATER DRIP TRAYS

▲4799	24" Water Drip Tray	Bag	6	4.5
▲4800	28" Water Drip Tray	Bag	6	5.1

PAD FRAME LATCHES

4791	Pad Frame Latch Assembly	Bulk	10	0.2
▲4792	Pad Frame Latch Assembly (2 per)	Bag	10	0.4
▲47925	Pad Frame Latch Assembly (2 per)	Bag	25	0.8
▲4793	Pad Frame Latch Assembly (2 per)	Clam	10	0.5
4795	Metal Pad Frame Latch	Bulk	10	0.4
▲4797	Metal Pad Frame Latch (2 per)	Clam	10	0.9
▲4785	Tradewinds Pad Latch (2 per)	Clam	10	0.3
▲4786	Tradewinds Corner Wire Latch	Clam	10	0.5



TRADEWINDS PAD LATCH



METAL PAD LATCH



TW CORNER WIRE LATCH

▲UPC Items



4000



4001

Dial P/N	Description/Packaging	Pkg	Ctn Qty	Ctn Wt
“HOW TO” BOOKS				
▲4000	Evaporative Cooler “How To” Book		10	3.3
4001	Cooler Maintenance & Troubleshooting Guide - English		25	1.5
40015	Cooler Maintenance & Troubleshooting Guide - English		125	8.4
4062	Cooler Maintenance & Troubleshooting Guide - Spanish		25	1.5



5011

BLEED OFF KITS

Prevents scale build-up and algae by effectively changing out the cooler water...designed to eliminate approximately 90% of mineral build-up caused by evaporation...Heavy duty tee will not corrode and easily connects to existing pump hose. Rate of bleed varies with pump pressure and bleed tee orifice size.

Bleed Off Kit Includes: • 1/4" 25' Copper Poly Tube • Bleed Tee • 2 Pump Hose Clamps • Instructions

▲5009	1/2 Bleed Off Kit	For standard 1/2" I.D. pump hose with 25 ft. of poly tube.	Bag	10	4.4
▲5011	1/2 Bleed Off Kit		Clam	10	5.1
▲5019	1/2 Bleed Tee	Tee only for 1/2" pump hose	Bulk	10	0.1
5022	1/2 Bleed Tee		Bulk	50	0.4
▲5023	1/2 Bleed Tee/Clamps	Tee and 2 pump hose clamps	Bag	10	0.1
▲50235	1/2 Bleed Tee/Clamps		Bag	25	0.2
▲5025	1/2 Bleed Tee/Clamps		Clam	10	0.2
5030	5/8 Bleed Tee	Tee only for 5/8" pump hose	Bulk	10	0.1



5152



5157

ANODE KITS

Magnesium Anode - Controls rust-electrolysis. Works as a sacrificial metal to protect cooler cabinet and parts. A unique anode tray design keeps anode above metal cooler bottom and allows anode to degrade evenly on all sides. Safe to use and easy to install.

▲5152	Magnesium Cooler Anode Kit	Kit includes anode, grounding wire, sediment collecting tray and instructions.	Clam	12	3.5
-------	----------------------------	--	------	----	-----

Zinc Anode - Controls rust-electrolysis as a sacrificial metal, similar to magnesium anodes, but also inhibits bacteria, mold and mildew. Stops the smell and freshens the air.

5157	Zinc Cooler Anode Kit	Kit includes anode, grounding wire, sediment collecting tray and instructions.	Clam	12	10.5
------	-----------------------	--	------	----	------

LIQUID TREATMENTS

Cooler Cleaner - Provides a one step treatment to inhibit buildup of scale, rust, and offensive odor. Conditions cooler pad to reduce air temperature and contains mild acid and wetting agents. Not for potable water.

▲5218	Pint Cooler Cleaner	Bottle	12	15.5
▲5225	Quart Cooler Cleaner	Bottle	12	28.0
▲5231	Gallon Cooler Cleaner	Bottle	4	35.9

Heavy Duty D-SCALE™ - New concentrated formulation to effectively treat scale and mineral buildup. Not for potable water.

▲5242	Quart Heavy Duty D-SCALE™	Bottle	12	28.0
▲5244	Gallon Heavy Duty D-SCALE™	Bottle	4	35.9

AIR FRESHENERS

Fresh Air™/Cooler Tab™ - A time release formula that controls unpleasant odors from algae and bacteria in evaporative coolers and neutralizes odor in cooler water to freshen the air. Not for potable water.

▲5255	Fresh Air™	Cake - can be divided 4 ways	Box	12	4.6
▲5279	Cooler Tab™	Tablet - for bottom of cooler	Clam	10	1.3



QUART



GALLON



QUART D-SCALE™



GALLON D-SCALE™



TABLET



CAKE



EVAPORATIVE COOLER PARTS

COOLER CARE

Dial P/N	Description/Packaging	Pkg	Ctn. Qty.	Ctn. Wt.
----------	-----------------------	-----	-----------	----------

WATER CONDITIONERS

Scale Eliminator™/Water Supply Line Scale Eliminator™ - Controls scale buildup and corrosion in coolers. Special formula holds minerals in suspension by raising the solubility level of the water, reduces mineral buildup on pads and must be used with a bleed off kit or PowerClean™ purge pump to flush suspended minerals. Lasts all season and is easy to install.

▲5284	Scale Eliminator™	Mesh bag rests in cooler pan water	Clam	10	2.8
▲52825	Scale Eliminator		Bag	20	5.6
▲5178	Water Supply Line Scale Eliminator™	Cartridge attaches to 1/4" copper or poly tube water line. PN 5178 includes Quick Connect Fittings	Clam	6	6.6
▲51795	Water Supply Scale Eliminator w/Brass Fittings	PN 51795 includes brass fittings For Outdoor Use Only. Not for potable water.	Pkg	8	8.9



WATER SUPPLY LINE SCALE ELIMINATOR™



SCALE ELIMINATOR



AEROSOL COATING



PREMIUM "ONE COAT" COATING



COARSE COATING BRUSH



TAN, GRAY AND ALUMINUM

PREMIUM "ONE COAT" COATING INTERIOR COOLER COATING

The only "one coat" coating on the market. This is a heavy bodied, thick asphaltic base coating, not a thin clay base coating. Designed to coat and seal evaporative cooler bottom pans...protects against rust and corrosion all season...also has sound deadening qualities... resistant to moisture...non-asbestos...fast drying

▲5324	13 Oz. Aerosol Coating	Fast drying, spray...aerosol coating.	Can	12	13.7
▲5328	20 Oz. Aerosol Coating		Can	12	20.0
▲5347	Quart Coating	Premium, heavy bodied, thick asphaltic "one coat" coating...apply with a brush.	Can	12	27.9
▲5351	Gallon Coating		Can	4	34.3
▲5366	5 Gallon Coating		Can	1	42.9
▲5749	Coarse Coating Brush	Thick polypropylene fiber brush - 3-1/8" wide - for applying coating.	Label	12	4.8

AEROSOL EXTERIOR COOLER PAINT

▲5623	12 Oz. Cooler Spray Paint	Standard Tan/Almond Color	Can	12	12.6
▲5624	12 Oz. Cooler Spray Paint	Gray for 1995 and newer Phoenix and Frigiking coolers.	Can	12	12.6
▲5637	12 Oz. Cooler Spray Paint	Standard Chrome Aluminum	Can	12	13.3

ZOOM SPOUT OIL

Zoom Spout Oil - For cooler bearings and some cooler motors with oilable bearings. Lubricate shaft bearings at the start of every season and every 60 days during season. Inhibits rust and oxidation. Comes in 4 oz. Zoom Spout bottle and .3 oz. tube.

▲5713	Zoom Spout Cooler Oil	Bottle	12	3.7
▲5714	Zoom Spout Cooler Oil	Bottle	24	7.4
▲5718	Qwik Lube™ Cooler Oil	Tube	50	1.6



ZOOM SPOUT OIL



QWIK LUBE™ OIL

CLEANING BRUSH AND SCRAPER

Wire Brush/Scraper - Rugged wire bristles for cleaning scale build-up, lime-mineral deposits, algae, rust and dirt from cooler pan, pad frames and parts. Includes metal scraper.

▲5744	Wire Brush & Scraper	Label	12	3.7
-------	----------------------	-------	----	-----



WIRE BRUSH & SCRAPER

PEEL N SEAL® - TAPE

▲5708	10 Ft. Peel N Seal®	All weather, heavy duty, pressure sensitive tape with an aluminum foil backing that will provide an instant water resistant bond...for roof, duct, cooler and many other uses.	Pkg	12	7.8
-------	---------------------	--	-----	----	-----



PEEL N SEAL®

V-BELTS



PRECISION ENGINEERED V-BELTS



- Standard "Type A" High Quality
- For Fractional Horsepower Motors
- 1/2" wide x 5/16" thick
- Packaged in Sleeves

Dial P/N	Size	Ref. #	Ctn Qty	Ctn Wt
▲6517	17"	4L170	5	0.7
▲6518	18"	4L180	5	0.7
▲6519	19"	4L190	5	0.6
▲6520	20"	4L200	5	0.7
▲6521	21"	4L210	5	0.7
▲6522	22"	4L220	5	0.7
▲6523	23"	4L230	5	0.7
▲6524	24"	4L240	5	0.8
▲6525	25"	4L250	5	0.8
▲6526	26"	4L260	5	0.9
▲6527	27"	4L270	5	0.9
▲6528	28"	4L280	5	0.9
▲6529	29"	4L290	5	0.9
▲6530	30"	4L300	5	1.0
▲6531	31"	4L310	5	1.0
▲6532	32"	4L320	5	1.0
▲6533	33"	4L330	5	1.1
▲6534	34"	4L340	5	1.1
▲6535	35"	4L350	5	1.1
▲6536	36"	4L360	5	1.1
▲6537	37"	4L370	5	1.1
▲6538	38"	4L380	5	1.2
▲6539	39"	4L390	5	1.2
▲6540	40"	4L400	5	1.2
▲65405	40"	4L400	10	2.4
▲6541	41"	4L410	5	1.3
▲6542	42"	4L420	5	1.3
▲6543	43"	4L430	5	1.3
▲6544	44"	4L440	5	1.3
▲65445	44"	4L440	10	2.6
▲6545	45"	4L450	5	1.4
▲65455	45"	4L450	10	2.8
▲6546	46"	4L460	5	1.4
▲65465	46"	4L460	10	2.8
▲6547	47"	4L470	5	1.4
▲65475	47"	4L470	10	2.8
▲6548	48"	4L480	5	1.5
▲65485	48"	4L480	10	3.0
▲6549	49"	4L490	5	1.5
▲65495	49"	4L490	10	3.0
▲6550	50"	4L500	5	1.5
▲65505	50"	4L500	10	3.0
▲6551	51"	4L510	5	1.6

Dial P/N	Size	Ref. #	Ctn Qty	Ctn Wt
▲65515	51"	4L510	10	3.2
▲6552	52"	4L520	5	1.6
▲65525	52"	4L520	10	3.2
▲6553	53"	4L530	5	1.6
▲65535	53"	4L530	10	3.2
▲6554	54"	4L540	5	1.6
▲65545	54"	4L540	10	3.2
▲6555	55"	4L550	5	1.7
▲65555	55"	4L550	10	3.4
▲6556	56"	4L560	5	1.8
▲65565	56"	4L560	10	3.6
▲6557	57"	4L570	5	1.8
▲65575	57"	4L570	10	3.6
▲6558	58"	4L580	5	1.8
▲65585	58"	4L580	10	3.6
▲6559	59"	4L590	5	1.9
▲65595	59"	4L590	10	3.8
▲6560	60"	4L600	5	1.9
▲65605	60"	4L600	10	3.8
▲6561	61"	4L610	5	1.9
▲65615	61"	4L610	10	3.8
▲6562	62"	4L620	5	1.9
▲65625	62"	4L620	10	3.8
▲6563	63"	4L630	5	1.9
▲65635	63"	4L630	10	3.8
▲6564	64"	4L640	5	1.9
▲65645	64"	4L640	10	3.8
▲6565	65"	4L650	5	2.0
▲65655	65"	4L650	10	4.0
▲6566	66"	4L660	5	2.1
▲65665	66"	4L660	10	4.2
▲6567	67"	4L670	5	2.1
▲65675	67"	4L670	10	4.2
▲6568	68"	4L680	5	2.1
▲65685	68"	4L680	10	4.2
▲6569	69"	4L690	5	2.1
▲65695	69"	4L690	10	4.2
▲6570	70"	4L700	5	2.1
▲6571	71"	4L710	5	2.2
▲6572	72"	4L720	5	2.2
▲6573	73"	4L730	5	2.2
▲6574	74"	4L740	5	2.2
▲6575	75"	4L750	5	2.2

Dial P/N	Size	Ref. #	Ctn Qty	Ctn Wt
▲6576	76"	4L760	5	2.3
▲6577	77"	4L770	5	2.4
▲6578	78"	4L780	5	2.4
▲6579	79"	4L790	5	2.4
▲6580	80"	4L800	5	2.5
▲6581	81"	4L810	5	2.5
▲6582	82"	4L820	5	2.5
▲6583	83"	4L830	5	2.5
▲6584	84"	4L840	5	2.5
▲6585	85"	4L850	5	2.6
▲6586	86"	4L860	5	2.6
▲6587	87"	4L870	5	2.7
▲6588	88"	4L880	5	2.7
▲6589	89"	4L890	5	2.7
▲6590	90"	4L900	5	2.8
▲6591	91"	4L910	5	2.8
▲6592	92"	4L920	5	2.8
▲6593	93"	4L930	5	2.8
▲6594	94"	4L940	5	2.9
▲6595	95"	4L950	5	2.9
▲6596	96"	4L960	5	3.0
▲6597	97"	4L970	5	3.0
▲6598	98"	4L980	5	3.0
▲6599	99"	4L990	5	3.0
▲6600	100"	4L1000	5	3.2
6500	Measuring Gauge		1	1.5

Belts from 40" to 69" are packed in cartons with tear away lids.





EVAPORATIVE COOLER PARTS

BEARINGS

Dial P/N	Description / Packaging	Pkg	Ctn. Qty.	Ctn. Wt.
----------	-------------------------	-----	-----------	----------

PILLOW BLOCK BEARINGS

6613	5/8" Pillow Block Bearing		Bulk	180	57.5
6630	5/8" Pillow Block Bearing		Bulk	24	7.8
▲6633	5/8" Pillow Block Bearing	5/8" Pillow Block Assembly	Bag	10	3.3
▲66335	5/8" Pillow Block Bearing		Bag	10	3.3
▲6634	5/8" Pillow Block Bearing		Clam	6	2.4
6615	3/4" Pillow Block Bearing		Bulk	180	59.0
6639	3/4" Pillow Block Bearing		Bulk	24	7.9
▲6642	3/4" Pillow Block Bearing	3/4" Pillow Block Assembly	Bag	10	3.4
▲6643	3/4" Pillow Block Bearing		Clam	6	2.4
6645	3/4" High Rise Pillow Block Brg.		Bulk	24	10.7
▲6644	3/4" High Rise Pillow Block Brg.	3/4" High Rise Pillow Block Assembly for Arctic Circle®, Arvin® and McGraw® coolers	Bag	10	4.6
▲6646	3/4" High Rise Pillow Block Brg.		Clam	6	3.0
6617	1" Pillow Block Bearing		Bulk	180	59.1
6660	1" Pillow Block Bearing		Bulk	24	7.9
▲6663	1" Pillow Block Bearing	1" Pillow Block Assembly	Bag	10	3.4
▲6664	1" Pillow Block Bearing		Clam	6	2.4
6651	1" High Rise Pillow Block Brg.		Bulk	24	10.7
▲6655	1" High Rise Pillow Block Brg.	1" High Rise Pillow Block Assembly for Arctic Circle®, Arvin®, and McGraw® coolers	Bag	10	4.6
▲6656	1" High Rise Pillow Block Brg.		Clam	6	3.0
6620	1" Pillow Block Side Oiler		Bulk	24	7.9
▲6622	1" Pillow Block Side Oiler	Oiler rotated 90° for side draft Tradewind coolers only	Clam	6	2.4
6672	1-3/16" Pillow Block Bearing	1-3/16" Light Duty Industrial P. Block	Bulk	6	6.0
6679	1-3/16" Pillow Block Bearing	1-3/16" Heavy Duty Industrial P. Block	Bulk	6	14.8

SPIDER BEARINGS

6683	5/8" Spider Bearing		Bulk	6	6.2
▲6684	3/4" Spider Bearing	5/8" bearing has 7" arms, 3/4" and 1" bearings have 9" arms.	Label	6	6.3
▲6686	1" Spider Bearing		Label	6	6.3

BEARING BALLS AND CUSIONS

6690	5/8" Bearing Ball and Cushion	5/8" Bearing Ball & Cushion Only	Bulk	10	1.7
6695	3/4" Bearing Ball and Cushion		Bulk	10	1.7
▲6692	3/4" Bearing Ball and Cushion (1 per)	3/4" Bearing Ball & Cushion Only	Clam	6	1.3
▲6696	3/4" Bearing Ball and Cushion (2 per)		Bag	6	2.4
6698	1" Bearing Ball and Cushion		Bulk	10	1.8
▲6693	1" Bearing Ball and Cushion (1 per)	1" Bearing Ball & Cushion Only	Clam	6	1.3
▲6699	1" Bearing Ball and Cushion (2 per)		Bag	6	2.4

COLLARS AND WASHERS

6804	3/4" Hollow Steel Collar	3/4" and 1" Stamped Galvanized Steel Collar with Set Screw	Bulk	10	0.8
6808	1 Hollow Steel Collar		Bulk	10	1.0
▲6802	3/4" Hollow Steel Collar & Washer		Bag	10	0.6
▲68025	3/4" Hollow Steel Collar & Washer		Bag	20	1.2
▲6805	3/4" Hollow Steel Collar & Washer	Stamped Galvanized Steel Collar (1 per), Set Screw & Leather Washer (1 per)	Clam	10	0.7
▲6803	1 Hollow Steel Collar & Washer		Bag	10	0.9
▲68035	1 Hollow Steel Collar & Washer		Bag	20	1.8
▲6806	1 Hollow Steel Collar & Washer		Clam	10	1.0
6813	5/8" Solid Steel Collar		Bulk	10	0.6
6825	3/4" Solid Steel Collar	Standard Solid Steel Collar with Zinc plating to resist corrosion and with Set Screw. Heavy Duty	Bulk	10	0.6
6832	1 Solid Steel Collar		Bulk	10	0.9
6839	1-3/16 Solid Steel Collar		Bulk	10	1.1
6809	Solid Steel Collar Set Screw	For 3/4" & 1" Solid Steel Collars	Bulk	10	0.1
▲6845	3/4" Solid Steel Collar and Washer	Zinc Plated Solid Steel Collar with Set Screw and Leather Washer	Clam	10	0.8
▲6846	1 Solid Steel Collar and Washer		Clam	10	1.1
6910	5/8" Leather Washer	5/8" Leather Washer	Bulk	10	0.1
6927	3/4" Leather Washer	3/4" Leather Washer	Bulk	10	0.1
▲6928	3/4" Leather Washer	3/4" Leather Washer (2 per)	Bag	10	0.3
6933	1 Leather Washer	1" Leather Washer	Bulk	10	0.1
▲6934	1 Leather Washer	1" Leather Washer (2 per)	Bag	10	0.3
6944	1-3/16 Leather Washer	1-3/16" Leather Washer	Bulk	10	0.1

BLOWER SHAFTS

6714	3/4" x 21" Shaft		Bulk	5	7.0
▲6713	3/4" x 21" Shaft		Label	5	7.0
6717	3/4" x 24" Shaft	Polished Steel and Chamfered Ends with 1-1/2" Flats.	Bulk	5	7.0
▲6716	3/4" x 24" Shaft		Label	5	7.0
6719	3/4" x 27" Shaft		Bulk	5	7.8
▲6718	3/4" x 27" Shaft		Label	5	7.8
6721	1 x 24" Shaft	Premium Shafts with Flats create a flat surface to securely attach set screw.	Bulk	5	9.4
▲6722	1 x 24" Shaft		Label	5	9.4
6737	1 x 27" Shaft		Bulk	5	11.2
▲6736	1 x 27" Shaft		Label	5	11.2
▲6749	1/4" x 1/4" x 1-1/2" Shaft Key 1" x 27" Shaft	Universal Blower Shaft Key	Bulk	10	0.3
▲6750	1/4" x 1/4" x 1-1/2" Shaft Key		Clam	10	0.4



PILLOW BLOCK BEARING



HIGH RISE PILLOW BLOCK BEARING



PILLOW BLOCK SIDE OILER

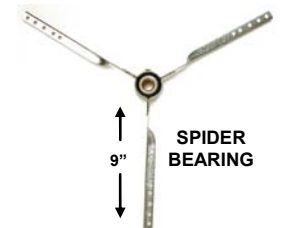

SPIDER BEARING



BEARING BALL & CUSHION



ECONOMY HOLLOW STEEL COLLAR



STANDARD SOLID STEEL COLLAR



LEATHER

WASHER



SHAFT WITH FLAT FOR SET SCREW



BLOWER SHAFT

▲UPC Items

Dial P/N	Description	Dia.	Bore	Pkg	Carton Qty.	Carton Wt.
----------	-------------	------	------	-----	-------------	------------

BLOWER PULLEYS — ZINC — WITH KEYWAY

▲6307	7 x 5/8" Blower Pulley	7"	5/8"	Label	5	5.8
▲6309	7 x 3/4" Blower Pulley	7"	3/4"	Label	5	5.7
▲6310	7 x 1" Blower Pulley	7"	1"	Label	5	5.7
▲6311	8 x 5/8" Blower Pulley	8"	5/8"	Label	5	6.1
▲6312	8 x 3/4" Blower Pulley	8"	3/4"	Label	5	6.1
▲6314	8 x 1 Blower Pulley	8"	1"	Label	5	6.0
▲6319	9 x 3/4" Blower Pulley	9"	3/4"	Label	5	6.7
▲6321	9 x 1" Blower Pulley	9"	1"	Label	5	6.8
▲6323	10 x 3/4" Blower Pulley	10"	3/4"	Label	5	7.5
▲6324	10 x 1" Blower Pulley	10"	1"	Label	5	7.4
▲6328	11 x 3/4" Blower Pulley	11"	3/4"	Label	5	9.7
▲6330	11 x 1" Blower Pulley	11"	1"	Label	5	9.8
▲6336	12 x 3/4" Blower Pulley	12"	3/4"	Label	5	10.4
▲6338	12 x 1" Blower Pulley	12"	1"	Label	5	10.3
▲6340	14 x 3/4" Blower Pulley	14"	3/4"	Label	5	14.2
▲6341	14 x 1" Blower Pulley	14"	1"	Label	5	14.1



**BLOWER PULLEY
WITH KEYWAY**

FIXED MOTOR PULLEYS — ZINC

5/8" bore Pulleys have Keyways

6207	2 x 1/2" Motor Pulley	2"	1/2"	Bulk	20	5.0
6209	2 x 5/8" Motor Pulley	2"	5/8"	Bulk	20	5.6
6211	2-1/4 x 1/2" Motor Pulley	2-1/4"	1/2"	Bulk	20	8.0
6219	2-1/4 x 5/8" Motor Pulley	2-1/4"	5/8"	Bulk	20	8.5
6235	2-1/2" x 1/2" Motor Pulley	2-1/2"	1/2"	Bulk	20	8.2
6237	2-1/2" x 5/8" Motor Pulley	2-1/2"	5/8"	Bulk	20	8.7
6240	2-3/4" x 1/2" Motor Pulley	2-3/4"	1/2"	Bulk	20	9.0
6255	2-3/4" x 5/8" Motor Pulley	2-3/4"	5/8"	Bulk	20	9.5
6262	3 x 1/2" Motor Pulley	3"	1/2"	Bulk	20	10.0
6271	3 x 5/8" Motor Pulley	3"	5/8"	Bulk	20	10.5
6280	3-1/4 x 1/2" Motor Pulley	3-1/4"	1/2"	Bulk	20	9.0
6286	3-1/4 x 5/8" Motor Pulley	3-1/4"	5/8"	Bulk	20	9.0
6293	3-1/2" x 1/2" Motor Pulley	3-1/2"	1/2"	Bulk	20	9.0
6298	3-1/2" x 5/8" Motor Pulley	3-1/2"	5/8"	Bulk	20	9.0
62985	4 x 5/8" Motor Pulley	4"	5/8"	Bulk	20	11.0



**FIXED
PULLEY**

FIXED MOTOR PULLEYS — ZINC PACKAGED

▲6215	1/3" H.P. Motor Pulley	2-1/4"	1/2"	Bag	10	4.2
▲6216	1/3" H.P. Motor Pulley			Pkg	6	2.7
▲6244	1/2" H.P. Motor Pulley	2-3/4"	1/2"	Bag	10	4.6
▲6245	1/2" H.P. Motor Pulley			Pkg	6	2.9
▲6264	3/4" H.P. Motor Pulley	3"	1/2"	Bag	10	5.5
▲6265	3/4" H.P. Motor Pulley			Pkg	6	3.5

***Note:** Above fixed pulleys are sized to avoid overloading cooler motors that are installed without using an ammeter



EVAPORATIVE COOLER PARTS

PULLEYS

Dial P/N	Description	Dia.	Bore	Motor	Pkg.	Carton Qty.	Carton Wt.
VARIABLE MOTOR PULLEYS — ZINC							
5/8 Bore Pulleys Have Keyways							
6122	3-1/4 x 1/2 Variable Pulley				Bulk	20	16.7
▲6123	3-1/4 x 1/2 Variable Pulley	3-1/4	1/2	1/3 HP	Bag	10	7.5
▲6124	3-1/4 x 1/2 Variable Pulley				Pkg	6	5.5
6128	3-1/4 x 5/8 Variable Pulley	3-1/4	5/8	1/3 HP	Bulk	20	18.4
▲6129	3-1/4 x 5/8 Variable Pulley				Bag	10	9.0
6143	3-1/2 x 1/2 Variable Pulley				Bulk	20	20.0
▲6144	3-1/2 x 1/2 Variable Pulley	3-1/2	1/2	1/2 HP	Bag	10	10.0
▲6145	3-1/2 x 1/2 Variable Pulley				Pkg	6	5.9
6147	3-1/2 x 5/8 Variable Pulley	3-1/2	5/8	1/2 HP	Bulk	20	20.4
▲6146	3-1/2 x 5/8 Variable Pulley				Bag	10	10.9
6148	3-3/4 x 1/2 Variable Pulley				Bulk	20	21.0
▲6151	3-3/4 x 1/2 Variable Pulley	3-3/4	1/2	1/2 or 3/4 HP	Bag	10	11.2
▲6149	3-3/4 x 1/2 Variable Pulley				Pkg	6	6.3
6152	3-3/4 x 5/8 Variable Pulley	3-3/4	5/8	1/2 or 3/4 HP	Bulk	20	18.4
▲6153	3-3/4 x 5/8 Variable Pulley				Bag	10	8.7
6167	4 x 1/2 Variable Pulley	4	1/2	1 HP	Bulk	20	37.6
▲6170	4 x 1/2 Variable Pulley				Bag	10	20.1
6171	4 x 5/8 Variable Pulley				Bulk	20	36.6
▲6172	4 x 5/8 Variable Pulley ♦	4	5/8	1 HP	Bag	4	7.0
▲6173	4 x 5/8 Variable Pulley ♦				Pkg	6	8.1

IMPORTANT: Variable pulleys must be opened 2-1/2 to 5 full turns, depending on air resistance, or motor will overheat.

IMPORTANT: If motor cycles (stops and starts due to overheating), open variable pulley until motor stops cycling. If cycling persists when pulley is fully opened, you must use next size **SMALLER** pulley. Always use pulley size recommended by cooler manufacturer.



ZINC VARIABLE (ADJUSTABLE) PULLEY

VARIABLE MOTOR PULLEYS — CAST IRON							
5/8 Bore Pulleys Have Keyways							
6190	3-1/4 x 1/2 Variable Iron Pulley	3-1/4	1/2	1/3 HP	Bulk	20	23.8
▲6191	3-1/4 x 1/2 Variable Iron Pulley	Same as 1VL34			Bag	6	7.6
6192	3-1/2 x 1/2 Variable Iron Pulley	3-1/2	1/2	1/2 HP	Bulk	20	26.9
▲6193	3-1/2 x 1/2 Variable Iron Pulley				Bag	6	8.5
6194	3-3/4 x 1/2 Variable Iron Pulley	3-3/4	1/2	1/2 or 3/4 HP	Bulk	20	29.5
▲6195	3-3/4 x 1/2 Variable Iron Pulley	Same as 1VL40			Bag	6	9.3
6196	3-3/4 x 5/8 Variable Iron Pulley	3-3/4	5/8	1/2 or 3/4 HP	Bulk	6	8.9
6197	4.15 x 1/2 Variable Iron Pulley ♦	4.15	1/2	1 HP	Bulk	6	11.0
6198	4.15 x 5/8 Variable Iron Pulley ♦	4.15	5/8	1 HP	Bulk	6	10.9
▲6199	4.15 x 5/8 Variable Iron Pulley ♦	Same as 1VL44			Bag	4	7.3

IRON VARIABLE (ADJUSTABLE) PULLEY

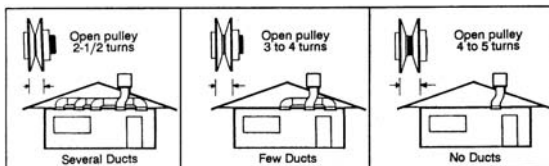

♦For 1 H.P. Single Inlet Coolers



PULLEY PULLER

MOTOR PULLEY AND SHAFT PLUGS

Dial P/N	Description	Pkg.	Carton Qty.	Carton Wt.
▲6100	Pulley Puller	Removes blower or motor pulley from shaft.	Label	5 6.2
▲6752	3/4 Blower Shaft Plug	Use as a plug to remove blower pulley on coolers with hollow shafts.	Clam	5 0.5
▲6755	1" Blower Shaft Plug		Clam	5 0.7

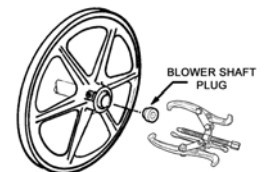

▲UPC Items

UL
RECOGNIZED
COMPONENT
ROTARY
SWITCHES



2 SPEED



2 GANG



6 POSITION



8 POSITION



PUSH BUTTON

Dial P/N	Description	Pkg.	Ctn. Qty.	Ctn. Wt.
WALL SWITCHES FOR COOLERS - UL RECOGNIZED				
Rotary wall switches use a 4 position switch for single speed coolers and 6 position for 2 speed coolers. Kits include: mounting screws and wiring diagram.				
▲7109	Two Speed Wall Switch	Bag	100	20.0
▲7110	Two Speed Wall Switch	Bag	10	2.0
▲71105	Two Speed Wall Switch	Bag	20	4.2
▲7112	Two Speed Wall Switch	Card	10	2.5
▲7115	Two Speed Wall Switch -Metal	Card	10	2.6
▲7131	Two Speed Wall Switch-2 Gang Metal	Card	10	2.8

6 POSITION COOLER SWITCHES

6 position cooler switch for single or 2 speed window view coolers or installations with cooler operating switch mounted to a ceiling grille. Use with Arctic Circle®, Arvin®, McGraw®, Phoenix®, Frigiking®, Champion and Essick® coolers. Stem length of shaft is 3/4 inch for short shaft switch and 2 inches for long shaft switches. Rated for motors up to 1/2 HP 16A 125 VAC.

7256	Two Speed Short Shaft Switch	Bulk	10	1.0
▲7260	Two Speed Short Shaft Switch	Clam	6	0.7
7271	Two Speed Long Shaft Switch	Bulk	10	1.1
▲7278	Two Speed Long Shaft Switch	Clam	6	0.8
▲7325	Two Speed Short Shaft Switch Kit	Bag	6	1.3
▲7334	Two Speed Long Shaft Switch Kit	Bag	6	1.3

8 POSITION COOLER SWITCHES

8 position cooler switch for 2 or 3 speed coolers with ceiling grilles or window view coolers. Short shafts have 5/8" stem, long shafts have 2-3/8" stem. Used on Arctic Circle®, Arvin®, McGraw®, and Wright coolers. Rated 25 amps at 115 volts for 1/3 to 1 H.P. cooler motors. When used with 2 speed motors, only 6 of the 8 switch positions are used.

7212	Two or 3 Speed Short Shaft Switch	Bulk	10	1.0
▲7219	Two or 3 Speed Short Shaft Switch	Clam	6	0.7
7225	Two or 3 Speed Long Shaft Switch	Bulk	10	1.0
▲7231	Two or 3 Speed Long Shaft Switch	Clam	6	0.7

WINDOW VIEW PUSH BUTTON SWITCH

7356	Two Speed Push Button Switch	Bulk	10	1.4
▲7361	Two Speed Push Button Switch	Clam	6	1.1



EVAPORATIVE COOLER PARTS

ELECTRICAL

Dial P/N	Description	Pkg.	Ctn. Qty.	Ctn. Wt.
KNOB KITS FOR 2 SPEED COOLERS				
Kits Include: knob, 6-position switch, inserts showing motor and pump operation at each position, a plain insert with only a pointer line and instructions.				
▲7485	Two Speed Short Shaft Knob Kit with Short Stem Knob (flush)	Clam	8	0.2
▲7486	Two Speed Medium Shaft Knob Kit with Medium Stem Knob (1/4")	Clam	8	0.2
▲7487	Two Speed Long Shaft Knob Kit with Long Stem Knob (5/8")	Clam	8	0.2

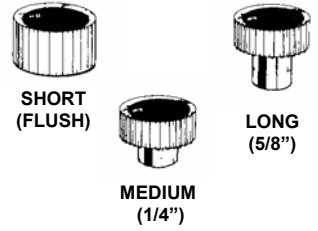

KNOB				
6-position knob for 6-position short and long shaft cooler switches (P2-169, P2-171). 8-position knob for 8-position short and long shaft cooler switches (P2-3006-1, P2-3006-3).				
7406	Six Position Short Pointer Knob (PA)	Bulk	10	0.1
7421	Six Position Short 2 Speed Knob (6A)	Bulk	10	0.1
7425	Six Position Short 2 Speed Knob (6B)	Bulk	10	0.1
7430	Eight Position Short 2 or 3 Speed Knob (8B)	Bulk	10	0.1
7436	Six Position Medium Pointer Knob (PA)	Bulk	10	0.1
7450	Six Position Medium 2 Speed Knob (6A)	Bulk	10	0.1
7453	Eight Position Medium Pointer Knob (PB)	Bulk	10	0.1
7456	Six Position Medium 2 Speed Knob (6B)	Bulk	10	0.1
7469	Six Position Long Pointer Knob (PA)	Bulk	10	0.2
7481	Six Position Long 2 Speed Knob (6A)	Bulk	10	0.2
7483	Six Position Long 2 Speed Knob (6B)	Bulk	10	0.2
7484	Eight Position Long 2 or 3 Speed Knob (8B)	Bulk	10	0.2
7497	Wall Switch Knob	Bulk	10	0.2
▲7499	Wall Switch Knob	Clam	6	0.2
7501	Wall Switch Knob for Newer "Made In China" Switches	Bulk	10	0.2

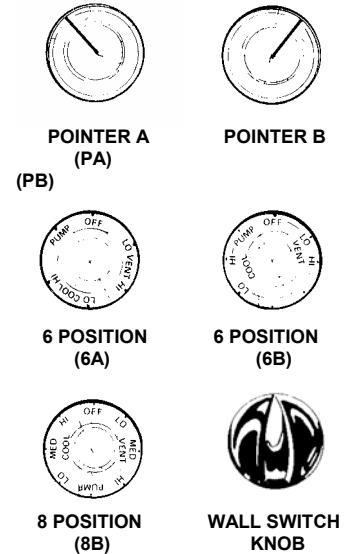

Dial P/N	Description	Pkg.	Ctn. Qty.	Ctn. Wt.
NEMA CORD AND NEMA RECEPTACLE SETS				
▲7512	One Speed 96" Outdoor 14/3 Motor Cord 120Volt	Label	10	8.8
▲7513	One Speed 144" Outdoor 14/3 Motor Cord 120Volt	Label	10	13.2
▲7514	One Speed 96" Indoor 16/3 Motor Cord 120Volt	Label	10	4.9
▲7524	Two Speed 84" Angle Plug Motor Cord 120Volt	Label	10	10.0
▲7526	Two Speed 144" Angle Plug Motor Cord 120Volt	Label	10	15.5
▲7570	Two Speed NEMA 14-20R Receptacle 120Volt	Box	10	0.2



7512 / 7513



7524 / 7526



7570

▲UPC Items

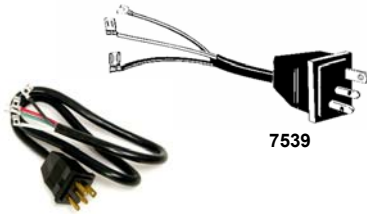

7539

7537 / 7545
7546 / 7548



7595 / 7599 / 7591



7597 / 7598



7583



7589



7547



7590



MINI PLUG



7555



7550 / 7551



7652

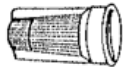

YELLOW TWIST CONNECTOR



7664



INTERIOR ELECTRICAL JUNCTION BOXES

Dial P/N	Description	Pkg.	Ctn. Qty.	Ctn. Wt.
----------	-------------	------	-----------	----------

MOLDED PLUG CORD & RECEPTACLE CORD SETS

Molded motor plug cords with 115 volt configuration will fit all the 115 volt molded motor receptacle cords and pigtails..all molded pump receptacle cords and pigtails will fit respective standard NEMA 115V or 230V prong configurations..motor plugs are terminalized.

FOR COOLERS WITH ELECTRICAL JUNCTION BOXES

7537	18" 2 Spd Motor Plug 115V/15A	14 gauge SJTW jacketed cord with 4 wires for 2 spd. Motors - up to 1 HP	Label	10	3.4
▲7595	18" Motor Receptacle 115V/15A	14 gauge 5 wire SJTW jacketed cord for 1 or 2 Spd motors up to 1 HP.	Label	10	3.1
▲7597	18" Pump Receptacle 115V/10A	18 gauge 3 wire SPT receptacle for standard 2 prong plus ground 115V plug.	Label	10	3.1
▲7539	36" 1 Spd Motor Plug 115V/15A	14 gauge SJTW jacketed cord with 3 wires for 1 Spd (P2-914) and 4 wires for 2 Spd (P2-911) motors - up to 1 HP	Label	10	4.4
▲7545	36" 2 Spd Motor Plug 115V/15A		Label	10	5.0
▲7546	36" 2 Spd Motor Plug 115V/15A		Clam	10	6.4
▲7548	42" 2 Spd Motor Plug 115V/15A	For 2 Spd (P2-911) motors - up to 1 HP for Champion RLD2 3001, 4001 and 5001 CFM	Label	10	5.8
▲7584	Pigtail Motor Receptacle 115-230V/15A	10 " leads, 14 gauge 5 wires for either 1 or 2 Spd motors up to 1 H.P. P2-905.	Bag	10	1.6
▲7583	Pigtail Motor Receptacle 115-230V/15A		Clam	6	1.7
▲7587	Pigtail Pump Receptacle 115V/10A	10 " leads. 18 gauge wire SPT receptacle for standard 2 prong plus ground 115V plug. P2-907.	Bag	10	1.6
▲7589	Pigtail Pump Receptacle 115V/10A		Clam	6	1.7
▲7599	38" Motor Receptacle 115V/15A	14 gauge 5 wire SJTW jacketed cord receptacle for 1 or 2 Spd motors up to 1 H.P.	Label	10	2.7
▲7598	38" Pump Receptacle 115V/10A	18 gauge 3 wire SPT cord receptacle for standard 2 prong plus ground 115V plug.	Label	10	2.6
▲7591	84" Motor Receptacle 115V/15A	14 gauge 5 wire SJTW jacketed cord receptacle for 1 or 2 Spd motors up to 1 H.P. P2-2150.	Label	10	3.9
7547	36" 230 Volt 2 Spd Motor Plug 230V/13A	16 gauge 4 wire SJTW jacketed cord for 1 or 2 spd motors up to 1 H.P..prongs are 230V configuration. P2-909.	Label	10	4.4
7590	Pigtail 230 Volt Pump Receptacle 230V/10A	10 " leads, 18 gauge 3 wire SPT receptacle for NEMA 230V (2 prong plus ground) plug. P2-908.	Bag	10	1.7

FOR MASTERCOOL® COOLERS

7585	36" Mini Plug & Cord 115V/15A		Bulk	100	30.0
▲7579	36" Mini Plug & Cord 115V/15A	14 gauge SJTW jacketed cord (16 gauge for 230V) 3 wires for 2 Spd motors up to 1 H.P.	Clam	10	3.3
7586	36" Mini Plug & Cord 230V/10A		Bulk	100	30.0
▲7581	36" Mini Plug & Cord 230V/10A		Clam	10	3.3

COOLER WHIP

10 FEET - 14 GAUGE WITH A GROUND WIRE

▲7555	10 Ft. Cooler Whip 115V/15A	For electrical hook-up of cooler to standard junction box. Water tight, non metallic, sun resistant. Components are UL Recognized, rated at 15 amps for up to 1 H.P. motors. Three 14 gauge motor wires and two 16 gauge wires for pump and ground.	Lbl	6	12.0
-------	-----------------------------	---	-----	---	------

SPOOL CORD

▲7550	250 Ft. 14 Gauge/4 Wire SJTW Jacketed Cord - 2 Spd		Spool	1	30.4
▲7551	250 Ft. 14 Gauge/5 Wire SJTW Jacketed Cord - 2 Spd		Spool	1	38.3

TERMINALS — TWIST CONNECTORS

7652	1/4" Straight Female Terminal	Straight 1/4" female terminal recommended for most rotary cooler switches.	Bulk	100	0.2
▲7657	1/4" Straight Female Terminal (6 per)		Clam	18	0.4
7664	1/4" Angle Female Terminal	Angle 1/4" female terminal recommended for most cooler motors.	Bulk	100	0.2
▲7670	1/4" Angle Female Terminal (6 per)		Clam	18	0.3
7682	Yellow Twist Connector	600 volt. min. of 2, 18 AWG wire. max of 3, 12 AWG wire.	Bulk	100	0.4
▲7689	Yellow Twist Connector (6 per)		Clam	10	0.3

INTERIOR ELECTRICAL JUNCTION BOXES

Suitable for universal mounting inside cooler ceiling, on motor cradles or on blower housing. Kits include a 3-wire pigtail pump receptacle (PN 7589 for 115V kits and PN 7590 for 230V kits) and a 1,2 or 3 spd pigtail motor receptacle (PN 7583 for both 115V & 230V)

▲7705	115 Volt Cooler Wiring Kit	Use as a quick disconnect for safely servicing coolers, includes a galvanized metal box	Box	1	1.5
▲7708	230 Volt Cooler Wiring Kit		Box	1	1.4



EVAPORATIVE COOLER PARTS

CONTROLLERS THERMOSTATS

Dial P/N	Description / Packaging	Ctn Qty.	Ctn Wt.
----------	-------------------------	----------	---------

COOLER™ CONTROLLER

2 Speed-1/3 to 1 HP-115 Volt

- Automatically controls the operation of an evaporative cooler.
- LCD digital temperature readout with electronic temperature sensor circuitry.
- Installs in standard depth 2 x 4 single gang electrical box.
- Four minute blower start delay when using pump feature for pad wetting
- Constant room temperature displayed.
- Case door covers operating controls
- Easy single touch temperature adjustment.
- UL Listed, 20 VAC, 1 HP, 125V 60Hz

▲7619	Digital Cooler Controller™ 115V	LCD digital temperature display, case door covers operating controls.	Clam	6	5.25
▲7616	Wall Plate for Digital Cooler Controller™ and Ezi-Stat™ Controller	Adapts Digital Cooler Controller and Ezi-Stat Controller™ to a 2 gang electrical junction box.	Bag	5	1.0



DIGITAL COOLER CONTROLLER™

EZI-STAT™ CONTROLLER

2 Speed-1/3 to 1 HP 115 and 230 Volt

- Automatically controls the operation and motor speed of an evaporative cooler.
- Optional manual control for cool (pump) and fan only and 2 / 4 / 8 hour timer mode.
- Automatic start and stop. Set and forget.
- UL Listed

▲7621	EziStat™ Controller 115/230V	Automatically adjusts motor speed	Clam	6	6.0
▲7625	EziStat™ Controller 115/230V		Clam	3	3.0



WALL PLATE FOR DIGITAL COOLER CONTROLLER™ & EZI-STAT™ CONTROLLER

SELECT-A-STAT™ CONTROLLER

2 Speed-1/3 to 3/4 HP-115 Volt

- Bimetallic temperature sensing with unique heat anticipator.
- Includes thermostat, motor switch, pump switch, leads and installation wiring diagram.
- Includes separate control of high and low speed blower motor and control of pump.
- Installs easily with 4 lead wires and ground terminal.
- Designed for installation in single gang or double gang electrical boxes (not included).
- Rated 15 amps at 115 volts VAC.
- UL listed.
- Automatic start and stop for temperature control

▲7620	SELECT-A-STAT™ Controller 115V	Line voltage thermostat and controller. Includes switches to control pump & 2 spd 15 amp motor.	Clam	6	7.4
-------	--------------------------------	---	------	---	-----



EZI STAT™ CONTROLLER

LINE-STAT™ THERMOSTAT

1 or 2 Speed-1/3 to 1 HP-115 Volt

- Automatic start and stop for temperature comfort.
- Does not include cooler switch or rotary wall switch.
- Includes thermostat, leads, screws, anticipator and installation wiring diagram.
- Requires single gang electrical box not included.
- Bimetallic sensing element with anticipator
- Rated 22 amps at 115 volts VAC.
- UL listed
- Easy to install with simple 2 wire hook-up.

▲7618	LINE STAT™ Thermostat 115V	Line voltage thermostat for 1/3 HP to 1 HP motors. Use with rotary wall switches...white.	Clam	4	2.4
-------	----------------------------	---	------	---	-----



SELECT-A-STAT™ CONTROLLER

DIGITAL LOW VOLT CONTROLLER™

2 Speed-1/3 to 1 HP-115 and 230 Volt

- Automatic start and stop for temperature comfort.
- Automatic pad pre-wet.
- Automatically adjusts from High to Low speed
- Digital Display
- Optional 2, 4, 8 hour timer
- Motor rated 1 HP 115V, 2HP 230V
- Pump rated 2 A @ 115 VAC and 1 A @ 230 VAC
- UL listed

▲7624	Digital Low Volt Controller™ 115V/230V	Digital design stat with separate controller in water proof box. Components are not interchangeable with other low voltage thermostats.	Pkg	2	29.5
-------	--	---	-----	---	------



LINE-STAT™ THERMOSTAT

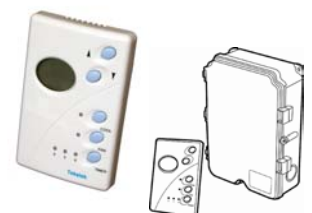

DIGITAL LOW-VOLTAGE THERMOSTAT & CONTROLLER BOX
▲UPC Items



UP-DUX®
See www.Up-Dux.com
and catalog page 32

Dial P/N	Description	Pkg	Ctn Qty.	Ctn Wt.
----------	-------------	-----	----------	---------

UP-DUX® CEILING TO ATTIC VENTS

Exhausts evaporative cooler air into attic. Eliminates excessive attic heat and the need to open windows and doors to vent air from cooler. Vents should be installed in the ceiling of each major room to allow the cool air to escape into the attic. The home can be locked while cooler is operating. Noise from outside is reduced.

- Improved home security with free attic venting.
- Easy to install
- Attractive ceiling grille.
- Cost free attic power-venting. Attic temps can reach 140° or more. Requires sufficient attic ventilation
- Up-Dux is rated 900 CFM nominal free air flow. Install one Up-Dux for each 900 CFM rating.
- DL-101 and DL-101-T models include ADR™, (Automatic Damper Release). At 190° ADR's fusible links will degrade and release anti-draft steel panels, blocking air flow between living areas and attic.
- Includes damper panel to secure venting during winter months.

▲7606	Economy "KD" (TPS-101)	Requires assembly. 7-1/4" height.	Box	6	22.0
▲7607	Extended Height Top-R™ (DL-101-T)	15-1/2" height to match R-38 attic insulation...includes ADR	Box	6	42.5
▲7608	Low Profile Height (LP-101)	Use when overhead clearance is limited. 3-1/2" Height	Box	6	19.0
▲7610	Deluxe Standard Height (DL-101)	Assembled 7-1/4" height. Includes ADR™	Box	6	30.0
▲76112	Slide-In Thermal Panels (3 per)	Fits all Up-Dux models	Bag	1	0.5
▲76114	Ceiling Grille	13-7/8" Square Polystyrene Grille	Box	12	9.0



7808/7809/7812/7815 Square

FOR 0 TO 6/12 PITCH



7805/7806 Round

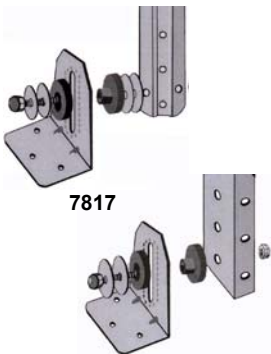

7817

7819

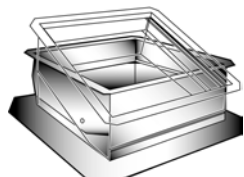

78317/78318

STANDARD COOLER LEG KITS

FOR ALL RESIDENTIAL COOLERS - FITS 0 TO 6/12 PITCH ROOFS

Kits include: two 30" long legs, two 20" short legs, 4 feet with fasteners and installation instructions.

Made with heavy gauge galvanized sheet metal and painted a standard Tan/Almond color or Gray color. Leg kits fit flat roofs and up to 6/12 pitch roofs. Square Corner leg kits also fit single inlet cooler models.

Round Corner Kits: for residential Arctic Circle®, Arvin®, McGraw®, Champion®, Essick®, Frigiking®, Wispercool™, Marquis™, Norrland™ and Alpine™ coolers.

Square Corner Kits: for residential Phoenix®, MasterCool®, AeroCool®, UltraCool®, Universal®, Sierra® and Century® coolers.

▲7805	Round Corner Cooler Leg Kit	2 30" long legs and 2 20" short legs. Standard Tan/Almond cooler color.	Bag	5	23.8
▲7808	Square Corner Cooler Leg Kit ♦		Bag	5	17.5
▲7806	Round Corner Gray Cooler Leg Kit	2 30" long legs and 2 20" short legs. Gray for Phoenix and Frigiking Coolers	Bag	5	23.6
▲7809	Square Corner Gray Cooler Leg Kit ♦		Bag	5	17.3
▲7812	Long Leg Only Square Corner Kit ♦	Tan...4. 30" long legs, feet and fasteners.	Bag	5	17.5
▲7815	Long Leg Square Corner Kit ♦	Tan...2. 38" long legs and 2 20" short legs for larger single inlet coolers.	Bag	5	25.5

VIBE-RX® COOLER LEG KITS

ISO MOUNT SYSTEM LEG KITS

Vibe-RX® cooler support legs incorporate Iso-Mount™ suspension to minimize the transfer of potential mechanical vibration for quieter cooler operation. 0.050" thick steel parts have a tan powder-coat finish.

▲7817	Vibe-RX® Round Corner Leg Kit	Tan...2. 30" long legs and 2 20" short legs with ISO-Mount feet and mounting hardware.	Bag	5	27.0
▲7819	Vibe-RX® Square Corner Leg Kit ♦		Bag	5	25.5
▲7820	Vibe-RX® Long Square Corner Leg Kit ♦	Tan...2. 38" long legs and 2 20" short legs with ISO-Mount feet and mounting hardware Fits larger single inlet coolers.	Bag	5	32.0

♦Fits Single Inlet Coolers

MULTI-PITCH™ ROOF JACKS

Multi-Pitch™ adjustable roof jacks are ideal for the installation of all major brands of residential ducted downdraft coolers. Roof jacks are made with galvanized sheet metal. A slide-in "winterizer" damper is included. Rails are preinstalled to support an optional Max Aire™ barometric damper. Roof jacks are flanged and adjustable for flat roofs and for roofs pitched up to 6"/12". 3000 to 4500 CFM jacks have a 17¾" discharge opening. 5500-7000 CFM jacks have a 19¾" discharge opening.

Caution: Roof jacks are intended for use as air distribution plenums only and not as supports for coolers. Use cooler legs to support cooler weight.

▲78317	18" Multi-Pitch™ Roof Jack w/Slide-in Damper	Box	1	13.0
▲78318	20" Multi-Pitch™ Roof Jack w/Slide-in Damper	Box	1	14.0



EVAPORATIVE COOLER PARTS

ACCESSORIES

Dial P/N	Description	Pkg.	Ctn Qty.	Ctn Wt.
COOLER INSTALLATION KITS				
FOR NEW COOLER INSTALLATION ON FLAT TO 6/12 PITCH ROOFS				
7832 and 7833 Kits include: <ul style="list-style-type: none"> Multi-Pitch™ Roof Jack Slide-In damper for winter Start collar Square to Round 7 ft. of non-insulated flex duct 				
7826 Kits include: Same as above and a Max-Air™ back draft barometric damper.				
▲7826	4500/6500 Cooler Installation Kit w/Barometric Damper	Deluxe kit with barometric damper and 20" roof jack for 4500 to 6500 CFM coolers.	Box	1 33.0
▲7832	4500 Cooler Installation Kit w/Slide-In Damper	Economy kits for either 3000 to 4500 or 5500 to 6500 CFM coolers.	Box	1 24.0
▲7833	6500 Cooler Installation Kit w/Slide-In Damper		Box	1 27.0

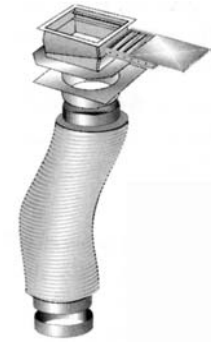

7626

COOLER INSTALLATION KITS



7832/7833

MAX AIRE™ BAROMETRIC DAMPERS				
CONSERVE ENERGY ON DOWNDRAFT COOLERS WITH BACK DRAFT DAMPERS				
<ul style="list-style-type: none"> All high grade aluminum construction. Automatic opening and closing of cooler ductwork. Fits Mission and Max-Aire jack design Designed for years of trouble free operation. 				
▲78235	18 x 18 Down Barometric Damper	17-3/4" Square...Aluminum...6 Blades	Box	1 4.8
▲78236	20 x 20 Down Barometric Damper	19-3/4" Square...Aluminum...5 Blades	Box	1 5.6

PLASTIC CEILING GRILLE				
FOR DUCTLESS INSTALLATIONS AND MOBILE HOMES				
Diffuses air 4 ways or 6 ways with 14 adjustable louvers, made with white colored, high impact plastic. Will not rust, corrode or stain. For duct openings up to 20" x 20". Grille is 22-1/2" x 22-1/2" x 3-1/8" depth. Easy to install. For all residential cooler models.				
▲7637	6 Way Grille 4500/6500 CFM	Air diffuser grille	Pkg	4 22.0
7932	Replacement Grille Louver (White)	Replacement louver for 6 way grille – White	Bulk	10 1.5
7626	Pillow Plug	Insulated winterizer pillow	Pkg	6 6.6



MAX AIRE™ DAMPER



PLASTIC CEILING GRILLE

PLASTIC CEILING & SIDEWALL REGISTERS				
Sizes shown are width and height dimensions for inside duct hole. Add 2" to width and height for outside dimensions. Plastic cooler, heating and air conditioning vents are economical and practical:				
<ul style="list-style-type: none"> Attractive brush finished trim can be painted to match decor. Built in opposed blade damper effect for system balancing. Easy to install, mounting screws and instructions included. Cleans with soap and water. Pull to open, push to close to operate damper. Will not rust. 				
▲7788	8 x 8 Plastic Ceiling Register	4 way	Pkg	6 6.1
▲7789	10 x 10 Plastic Ceiling Register	4 way	Pkg	6 10.2
▲7790	12 x 12 Plastic Ceiling Register	4 way	Pkg	6 11.8
▲7791	6 x 6 Plastic Sidewall Register	2 way	Pkg	6 3.8
▲7792	8 x 6 Plastic Sidewall Register	2 way	Pkg	6 5.8
▲7793	10 x 6 Plastic Sidewall Register	3 way	Pkg	6 7.0
▲7794	12 x 6 Plastic Sidewall Register	3 way	Pkg	6 8.0
▲7795	14 x 6 Plastic Sidewall Register	3 way	Pkg	6 8.5
▲7796	16 x 6 Plastic Sidewall Register	3 way	Pkg	6 10.5
▲7797	20 x 6 Plastic Sidewall Register	3 way	Pkg	6 12.5
▲7799	14 x 8 Plastic Sidewall Register	3 way	Pkg	6 10.7



PLASTIC CEILING REGISTERS

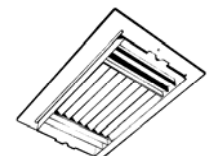

PLASTIC SIDEWALL REGISTERS

RETAINING WIRES				
FOR ARCTIC CIRCLE®, ARVIN®, McGRAW® COOLERS ONLY				
▲7971	16" Retaining Wires	Replacement Pad Frame Retaining Wires	Label	5 2.7
▲7972	21" Retaining Wires		Label	5 2.4
▲7973	27" Retaining Wires		Label	5 4.7
▲7974	30" Retaining Wires		Label	5 3.6

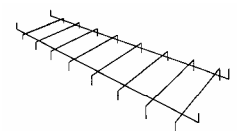

RETAINING WIRES

MasterCool® and ArcticCircle® are registered trademarks of AdobeAir, Inc. Arvin® is a registered trademark of Arvin Industries Inc.

▲UPC Items

DRAINS & CLAMPS

EVAPORATIVE COOLER PARTS



**BRASS
COOLER DRAIN***

**NYLON
COOLER DRAIN***



*2 flat sides. Fits Arctic Circle, MasterCool and all other coolers.



**POLY DRAIN &
OVERFLOW PIPE**



**NYLON DRAIN &
OVERFLOW PIPE***



OVERFLOW PIPE



**MAX-COOL
OVERFLOW DRAIN
ASSEMBLY**



**BRASS
SILL COCK**



**92375
MAX-COOL FLAT
SIDED BUSHING**



SADDLE VALVE



BRASS PLUG



BRASS CAP

9445
9446

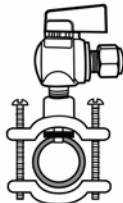

**PUMP HOSE
CLAMP**



**HOSE RING
CLAMP**



HEX KEYS



Dial P/N	Description	Pkg	Ctn Qty.	Ctn Wt.
DRAIN & OVERFLOW PIPE KITS				
▲9247 Poly Drain/Smooth Kit	Slip in, non-threaded overflow pipe, washer, poly drain with 3/4" male garden hose threads.	Bag	25	1.2
▲92475 Poly Drain/Smooth Kit		Bag	25	1.2
▲9249 Poly Drain/Smooth Kit		Clam	12	0.9
▲9240 Nylon Drain Kit*	1/2" MPT overflow pipe with flat sided hex head for easy install & removal, washer, nylon drain with 1/2" FPT I.D. and 3/4" male garden hose threads O.D.	Bag	25	1.5
▲92405 Nylon Drain Kit*		Bag	25	1.5
▲9244 Nylon Drain Kit*		Clam	12	1.1
▲9243 TW Nylon Drain Kit*	Same as PN 9240, except with longer overflow pipe for Tradewinds Coolers.	Clam	10	1.2
▲9230 Brass Drain Kit*	Same as PN9240, except with heavy duty brass drain.	Bag	25	3.7
▲9254 Brass Drain Kit*		Clam	12	2.2

DRAINS & OVERFLOW PIPES				
▲9205 Nylon Cooler Drain*	Nylon drain with 1/2" FPT for threaded overflow pipes, male garden hose threads O.D. Washer included. Flat sides for all coolers.	Bag	25	0.7
▲9209 Nylon Cooler Drain*		Clam	12	0.4
▲9225 Brass Cooler Drain*		Bag	25	2.9
▲92255 Brass Cooler Drain*	Same as above except with brass drain.	Bag	25	2.9
▲9229 Brass Cooler Drain*		Clam	12	1.5
9233 3-1/2 Threaded Overflow Pipe		Bulk	50	1.6
▲9235 3-1/2 Threaded Overflow Pipe	Threaded 1/2" MPT standpipe with hex head top, 3/2" overall height (1/2" thread length, 3" smooth length).	Bag	25	0.9
▲92355 3-1/2 Threaded Overflow Pipe		Bag	25	0.9
▲9236 3-1/2 Threaded Overflow Pipe		Clam	12	0.5
9234 4-3/4 Threaded Overflow Pipe	Same except extra 4 3/4" in length (1/2" thread length, 4 3/4" smooth length).	Bulk	10	0.4
6951 Rubber Washer for Cooler Drain	1-3/16" rubber washer	Bulk	10	0.1

MAX-COOL™ DRAIN AND OVERFLOW PIPE				
Flat sides for all coolers				
▲9239 Overflow Drain Assembly*	Prevents overflowing of cooler. Remove for cleaning.	Bag	10	1.0
▲92395 Overflow Drain Assembly*		Bag	25	2.0
▲92375 Flat Sided Bushing*	Flat sided plastic drain fitting with rubber washer fits all coolers. Use with Max-Cool style overflow pipe only.	Bag	20	1.4

SILL COCKS				
9252 Brass Sill Cock	Brass body, 3/4" FGH inlet x 3/4" MGH outlet with 1/2" FIP side tapped. Sill cock garden hose thread fits directly onto existing outdoor faucet. Attach angle needle valve or male compression coupling to side tapped 1/2" FIP to connect to cooler. Blue Handle.	Bulk	144	70.0
▲9251 Brass Sill Cock		Label	12	5.8
▲92515 Brass Sill Cock		Label	12	5.8
▲9253 Brass Sill Cock		Clam	8	4.4
▲9257 3/4 FPT Brass Sill Cock	Brass body, 3/4" FIP inlet x 3/4" MGH outlet with 1/2" FIP side tapped. 3/4" FIP fits directly onto pipe threads. Attach angle needle valve or male compression coupling to side tapped 3/4" FIP to connect to cooler. Red handle.	Label	12	5.8
▲92575 3/4 FPT Brass Sill Cock		Label	12	5.8
▲9258 3/4 FPT Brass Sill Cock		Clam	8	4.4
▲9520 1/8 MPT Brass Plug (1 per)	Winter seal for Sill Cock.	Clam	10	0.4
▲9525 1/4 cc Brass Cap (1 per)	Winter Seal for Float Valve.	Clam	10	0.4

SADDLE VALVES				
9267 1/4" Self Tapping SV		Bulk	200	48.0
▲9268 1/4" Self Tapping SV	Use to run water to cooler. Attaches to copper pipe 3/8" to 1-3/8" O.D. Available w/ rigid self piercing needle.	Bag	25	6.0
▲92685 1/4" Self Tapping SV		Bag	25	6.0
▲9270 1/4" Self Tapping SV		Clam	8	2.0
▲9272 1/4" Saddle Valve	Same except w/o self piercing needle.	Bag	25	6.1
▲9274 1/4" Saddle Valve	Must pre-drill hole.	Clam	8	2.1
▲9271 Deluxe 1/4" Self Tapping SV	Same with threaded lower clamp arm.	Bag	25	5.6
9445 1/4" SS Ball Valve & Brass Saddle	Heavy duty corrosion resistant stainless steel ball valve and brass saddle.	Bulk	25	7.4
▲9446 1/4" SS Ball Valve & Brass Saddle		Clam	10	3.6

PUMP HOSE RESTRICTOR CLAMPS				
9284 Pump Hose Clamp		Bulk	10	0.2
▲9287 Pump Hose Clamp	Regulates flow of water for maximum cooling efficiency. Excess water flow may damage cooler or ducts.	Clam	8	0.3
▲92875 Pump Hose Clamp		Bag	20	0.6

RING CLAMPS				
9289 1/4" Hose Ring Clamp	Fits 1/4" O.D. poly tube used on bleed off tees. (Gray)	Bulk	25	0.1
9294 1/2" Hose Ring Clamp		Bulk	25	0.2
▲9295 1/2" Hose Ring Clamp (2 per bag)	Fits standard 1/2" I.D. vinyl pump hose. (5/8" O.D. - Green)	Bag	10	0.2
▲9296 1/2" Hose Ring Clamp (2 per bag)		Clam	10	0.4
9298 5/8" Hose Ring Clamp	Fits 5/8" I.D. vinyl industrial pump hose. (3/4" O.D. - Bronze)	Bulk	25	0.3

HEX KEYS				
▲9277 5/32" Hex Key & Handle	6 inch long standard 5/32" hex key for use on adjustable and fixed motor pulleys, blower pulleys and collars.	Label	8	0.9
9278 5/32" x 2-1/2" Hex Key	Same except 2 1/2" long without handle.	Bulk	25	0.5
▲92785 5/32" x 2-1/2" Hex Key		Clam	10	0.6
9282 5/32" x 6" Hex Key	Same except 6" long without handle.	Bulk	25	1.2
9281 5/32" x 12" Hex Key	Same except 12" long without handle.	Bulk	25	2.0

▲UPC Items



EVAPORATIVE COOLER PARTS

BRASS FITTINGS

Dial P/N	Description	Pkg	Ctn. Qty.	Ctn. Wt.
COOLER DRAIN AND FEMALE GARDEN HOSE CAPS				
USE DRAIN CAP TO DRAIN WATER FROM COOLER WHERE OVERFLOW PIPE IS NOT USED OR WITH HOSE Y.				
9051	Female Brass Drain Hose Cap and Washer	Bulk	10	0.4
▲9054	Female Brass Drain Hose Cap and Washer	Clam	10	0.5
9043	Female Brass Hose Cap with 1/8" FPT Tap	Bulk	10	0.6
9048	Female Brass Hose Cap with 1/4" FPT Tap	Bulk	10	0.9
9265	Female Plastic Hose Cap and Washer	Bulk	10	0.2
▲9260	Plastic Hose Cap and Washer	Clam	10	0.3
6967	Standard Garden Hose Washer	Bulk	10	0.1



EASY PIPE ADAPTERS-SIDE TAPPED WITH 1/8" FPT

Attach to brass pipe, metal pipe, PVC pipe, or garden hose. Use 1/8" FPT to attach male union or angle needle valve to supply water to cooler. May also be used behind hose bib.

9011	Pipe Adapter 1/2" MPT x 1/2" FPT with 1/8" FPT Side Tap	Bulk	10	1.3
▲9015	Pipe Adapter 1/2" MPT x 1/2" FPT with 1/8" FPT Side Tap	Clam	6	0.8
▲90155	Pipe Adapter 1/2" MPT x 1/2" FPT with 1/8" FPT Side Tap	Bag	6	0.8
9020	Pipe Adapter 3/4" MPT x 3/4" FPT with 1/8" FPT Side Tap	Bulk	10	2.2
▲9026	Pipe Adapter 3/4" MPT x 3/4" FPT with 1/8" FPT Side Tap	Clam	6	1.5
▲90265	Pipe Adapter 3/4" MPT x 3/4" FPT with 1/8" FPT Side Tap	Bag	6	1.5
9032	Pipe Adapter 3/4" M. Hose x 3/4" F. Hose with 1/8" FPT Side Tap	Bulk	10	2.0
▲9037	Pipe Adapter 3/4" M. Hose x 3/4" F. Hose with 1/8" FPT Side Tap	Clam	6	1.3



GARDEN HOSE ADAPTER FOR MOBILE COOLERS

USE TO RUN WATER TO MOBILE COOLER

9056	Garden Hose x 1/4" Compression Float Valve Adapter	Bulk	10	0.7
▲9057	Garden Hose x 1/4" Compression Float Valve Adapter	Clam	6	0.5



SWIVEL BRASS HOSE ADAPTERS

ADAPTS GARDEN HOSE TO BRASS, METAL, OR PVC PIPE

9070	Female Hose x 1/2" FPT Swivel	Bulk	10	0.7
9074	Female Hose x 3/4" FPT Swivel	Bulk	10	1.3
9078	Female Hose x Female Hose Swivel	Bulk	10	1.4

BRASS HOSE ADAPTERS

ADAPTS GARDEN HOSE TO BRASS, METAL, OR PVC PIPE

9085	Male Hose x 3/4" MPT Hose Adapter	Bulk	10	1.4
9089	Male Hose x Male Hose Adapter	Bulk	10	1.4
9102	Female Hose x 3/4" MPT Hose Adapter	Bulk	10	1.1
9113	Male Hose x 3/4" FPT Hose Adapter	Bulk	10	1.3
9122	Female Hose x 3/4" FPT Hose Adapter	Bulk	10	1.3

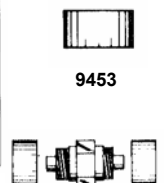

BRASS FITTINGS FOR POLY TUBING

USE WITH POLY TUBE

9453	1/4" Nut for Poly Tube Fittings	Bulk	25	0.2
9460	1/4" Poly Tube Full Union	Bulk	25	0.8
▲9462	1/4" Poly Tube Full Union	Clam	10	0.5
9465	1/4" Poly x 1/4" Copper Adapter Union	Bulk	25	1.9
▲9468	1/4" Poly x 1/4" Copper Adapter Union	Clam	10	0.6
9477	1/4" Poly x 1/8" MPT Male Coupling Union	Bulk	25	0.7
▲9480	1/4" Poly x 1/8" MPT Male Coupling Union	Clam	10	0.4
9483	1/4" Poly Float Valve Adapter to 1/4" Tapered Compr.Thread	Bulk	25	0.7
▲9484	1/4" Poly Float Valve Adapter to 1/4" Tapered Compr.Thread	Clam	10	0.4

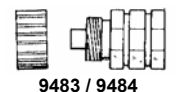
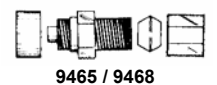

▲UPC Items



TUBE ADAPTER

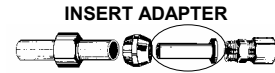

INSERT ADAPTER



BARBED ADAPTER

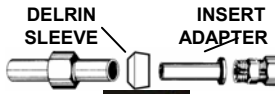

DELIRIN SLEEVE INSERT ADAPTER



SLEEVE



NUT



UNION



REDUCING UNION



FEMALE UNION



MALE UNION

Dial P/N	Description / Packaging	Pkg	Ctn. Qty.	Ctn. Wt.
ADAPTERS - POLY TUBE TO COMPRESSION FITTINGS				
9493	1/4" Poly Tube Adapter	For using 1/4" Brass Compression fittings with 1/4" Poly Tubing	Bulk	25 0.1
▲9495	1/4" Poly Tube Adapter (4 per)		Clam	10 0.2
9497	1/4" Poly Tube Insert Adapter		Bulk	25 0.1
▲9498	1/4" Poly Tube Insert Adapter (4 per)	Adapts Poly Tube to Brass Compression Fittings using 1/4" cc Sleeve	Clam	10 0.2
▲94985	1/4" Poly Tube Insert Adapter (4 per)		Clam	50 1.0
9500	1/4" Poly Barbed Adapter		Bulk	100 0.8
9502	1/4" Poly Barbed Adapter		Bulk	25 0.2
▲9503	1/4" Poly Barbed Adapter (4 per)	Adapts poly tube to brass fittings without using 1/4" cc Sleeve	Bag	10 0.1
▲95035	1/4" Poly Barbed Adapter (4 per)		Bag	50 0.5
▲9504	1/4" Poly Barbed Adapter (4 per)		Clam	10 0.4
9510	1/4" Delrin Sleeve	Use only on Poly Tube	Bulk	100 0.2
▲9512	1/4" Delrin Sleeve and 1/4" Poly Tube Brass Insert (2 per)		Clam	10 0.4
▲95125	1/4" Delrin Sleeve and 1/4" Poly Tube Brass Insert (2 per)		Clam	50 2.0

BRASS COMPRESSION FITTINGS

SLEEVE

9302	1/4" Compression Sleeve		Bulk	200 0.3
9304	1/4" Compression Sleeve (4 per)		Bulk	25 0.1
▲9305	1/4" Compression Sleeve (5 per)	Standard compression sleeve for 1/4" O.D. copper tube	Bag	10 0.1
▲93055	1/4" Compression Sleeve (5 per)		Bag	50 0.5
▲9310	1/4" Compression Sleeve (4 per)		Clam	10 0.2
9309	3/8" Compression Sleeve	Sleeve for 3/8" O.D. tube	Bulk	25 0.1

NUT

9313	1/4" Compression Nut		Bulk	100 1.2
9315	1/4" Compression Nut	Standard compression nut for 1/4" O.D. copper tube	Bulk	25 0.3
▲9316	1/4" Compression Nut (5 per)		Bag	10 0.7
▲93165	1/4" Compression Nut (5 per)		Bag	50 3.5
▲9312	1/4" Sleeve & 1/4" Nut (2 per)		Bag	10 0.3
▲93125	1/4" Sleeve & 1/4" Nut (2 per)	2 nuts and 2 sleeves	Bag	50 1.5
▲9311	1/4" Sleeve & 1/4" Nut (2 per)		Clam	10 0.4
9321	3/8" Compression Nut	Nut for 3/8" O.D. tube	Bulk	25 0.5

UNION

9324	1/4" Compression Union		Bulk	100 4.8
9326	1/4" Compression Union		Bulk	25 1.2
▲9328	1/4" Compression Union ♦		Bag	10 0.6
▲93285	1/4" Compression Union ♦	Standard compression union for copper tubes.	Bag	50 3.0
▲9329	1/4" Compression Union ♦		Clam	10 0.6
▲9327	1/4" Compression Union (5 per)		Bag	10 2.5
9331	5/16" Compression Union		Bulk	25 1.6
9334	3/8" Compression Union		Bulk	25 1.9

REDUCING UNIONS

9343	1/4" x 3/8" Reducing Union		Bulk	25 1.8
▲9345	1/4" x 3/8" Reducing Union	Standard reducing unions for copper tubes.	Clam	10 0.8
9338	1/4" x 5/16" Reducing Union		Bulk	25 1.4
▲9340	1/4" x 5/16" Reducing Union		Clam	10 0.8

FEMALE UNION

▲9357	1/4"cc x 1/8" FPT Female Union		Clam	10 0.5
9363	1/4"cc x 1/2" FPT Female Union		Bulk	25 1.8

MALE UNION

9370	1/4"cc x 1/8" MPT Male Union		Bulk	100 4.0
9372	1/4"cc x 1/8" MPT Male Union		Bulk	25 1.0
▲9373	1/4"cc x 1/8" MPT Male Union ♦		Bag	10 0.4
▲93735	1/4"cc x 1/8" MPT Male Union ♦	Use with copper or poly tube on side tapped sill cock or pipe adapter.	Bag	50 2.0
▲9375	1/4"cc x 1/8" MPT Male Union ♦		Clam	10 0.5
9377	1/4"cc x 1/4" MPT Male Union		Bulk	25 1.2
9378	1/4"cc x 1/2" MPT Male Union		Bulk	25 2.3
▲93781	1/4"cc x 1/2" MPT Male Union		Clam	10 0.9



EVAPORATIVE COOLER PARTS

BRASS FITTINGS

Part #	Description	Pkg	Ctn. Qty.	Ctn. Wt.
COMPRESSION ELBOW				
For Copper Water Supply Line				
93921	1/4" cc x 1/4" cc 90° Elbow	Bulk	25	1.6
▲93922	1/4" cc x 1/4" cc 90° Elbow	Clam	10	0.7
MALE ELBOW				
▲9391	1/4" cc x 1/8" MPT Male 90° Elbow ♦	Clam	10	0.7
COMPRESSION TEE				
For Connecting Coolers To 1 Water Source				
9395	1/4"cc x 1/4"cc x 1/4" cc Compression Tee	Bulk	25	2.4
▲9396	1/4"cc x 1/4"cc x 1/4" cc Compression Tee ♦	Clam	10	1.1
▲9397	1/4"cc x 1/4"cc x 1/4" cc Compression Tee ♦	Bag	10	1.0
▲93975	1/4"cc x 1/4"cc x 1/4" cc Compression Tee ♦	Bag	50	5.0
9399	3/8"cc x 3/8"cc x 3/8"cc Compression Tee	Bulk	25	3.4
MALE BRANCH TEE				
For Connecting Coolers To 1 Water Source				
9390	1/4"cc x 1/4"cc x 1/8" MPT Male Branch Tee	Bulk	25	1.8
▲93902	1/4"cc x 1/4"cc x 1/8" MPT Male Branch Tee ♦	Clam	10	1.0
ANGLE NEEDLE VALVE				
9436	1/4"cc x 1/8" MPT Angle Needle Valve	Bulk	100	7.6
9438	1/4"cc x 1/8" MPT Angle Needle Valve	Bulk	25	1.9
▲9439	1/4"cc x 1/8" MPT Angle Needle Valve ♦	Bag	10	1.9
▲94395	1/4"cc x 1/8" MPT Angle Needle Valve ♦	Bag	50	9.5
▲9440	1/4"cc x 1/8" MPT Angle Needle Valve ♦	Clam	10	0.9
9442	1/4"cc x 1/8" MPT SS Angle Ball Valve	Bulk	25	3.0
▲9443	1/4"cc x 1/8" MPT SS Angle Ball Valve ♦	Clam	10	1.3
STRAIGHT NEEDLE VALVE				
9416	1/4" cc x 1/8" MPT Straight Needle Valve	Bulk	100	8.0
9418	1/4" cc x 1/8" MPT Straight Needle Valve	Bulk	25	2.0
▲9419	1/4" cc x 1/8" MPT Straight Needle Valve ♦	Bag	10	0.8
▲94195	1/4" cc x 1/8" MPT Straight Needle Valve ♦	Bag	50	4.0
▲9421	1/4" cc x 1/8" MPT Straight Needle Valve ♦	Clam	10	1.0
9422	1/4" cc x 1/4" MPT Straight Needle Valve	Bulk	25	4.3
9425	1/4"cc x 1/8" MPT SS Straight Ball Valve	Bulk	25	3.0
▲9426	1/4"cc x 1/8" MPT SS Straight Ball Valve	Clam	10	1.3
9433	3/8"cc x 1/4" MPT Straight Needle Valve	Bulk	25	4.4
COMPRESSION NEEDLE VALVE				
9401	1/4"cc x 1/4"cc Straight Compression Needle Valve	Bulk	100	10.8
9403	1/4"cc x 1/4"cc Straight Compression Needle Valve	Bulk	25	2.7
▲9404	1/4"cc x 1/4"cc Straight Compression Needle Valve ♦	Bag	10	1.1
▲94045	1/4"cc x 1/4"cc Straight Compression Needle Valve ♦	Bag	50	5.5
▲9406	1/4"cc x 1/4"cc Straight Compression Needle Valve ♦	Clam	10	1.1
9413	3/8" cc x 3/8" cc Straight Compression Needle Valve	Bulk	25	3.5
SADDLE VALVES				
To supply water to coolers, humidifiers, or ice makers.				
<i>Should only be attached to copper or steel pipe, not copper tubing or PVC pipe.</i>				
9267	1/4" Self Piercing Saddle Valve	Bulk	200	24.0
▲9268	1/4" Self Piercing Saddle Valve	Bag	25	6.0
▲9270	1/4" Self Piercing Saddle Valve	Clam	8	2.0
▲9271	1/4" Self Piercing Saddle Valve Deluxe	Bag	25	5.6
▲9272	1/4" Saddle Valve-Non Piercing	Bag	25	6.1
▲9274	1/4" Saddle Valve-Non Piercing	Clam	8	2.1
9445	1/4" SS Ball Valve&Brass Saddle	Bulk	25	7.4
▲9446	1/4" SS Ball Valve&Brass Saddle	Clam	10	3.6
SPEEDFIT FITTINGS				
Quickly Connects 1/4 Poly to 1/4 Copper Tube				
9532	Speedfit 1/4 1/4 Compression Union	Bulk	25	1.0
▲9533	Speedfit 1/4 1/4 Compression Union	Clam	10	0.5
9535	Speedfit 1/4 1/8 Male Union	Bulk	25	0.9
▲9536	Speedfit 1/4 1/8 Male Union	Clam	10	0.4
9538	1/4 1/4 1/4 Compression Tee	Bulk	25	1.2
▲9539	1/4 1/4 1/4 Compression Tee	Clam	10	0.6

♦ Poly Tube Adapter Included

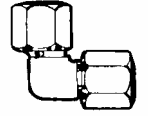

COMPRESSION ELBOW



MALE ELBOW



COMPRESSION TEE



MALE BRANCH TEE



ANGLE NEEDLE VALVE



ANGLE BALL VALVE (stainless steel)



STRAIGHT NEEDLE VALVE (stainless steel)



STRAIGHT BALL VALVE (stainless steel)



COMPRESSION NEEDLE VALVE



SADDLE VALVE



1/4 SS BALL VLV & BRASS SADDLE

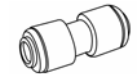

SPEEDFIT UNION



SPEEDFIT TEE

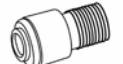

SPEEDFIT MALE UNION

▲UPC Items



DOWN



SIDE



WINDOW

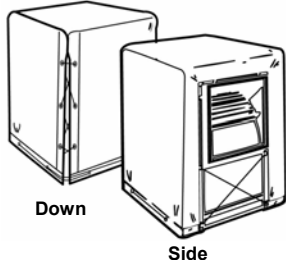

Down

Side

Helps to prevent rust and corrosion on cooler and cooler parts. Prolongs evaporative cooler life.

- Water repellant and mildew resistant.
- Rugged brass grommets for securing split cover.
- Heavy duty sun-resistant cord.
- Downdrafts have one split corner for coolers with electrical disconnect boxes on cooler exterior.
- Covers are made larger in width, depth and height to allow for shrinkage and minor cooler size variations.
- Each cover individually poly bagged with cover size in bold 1" high numbers and references cooler models.

Dial P/N	Type	W x D x H	Size Reference	Ctn. Qty.	Ctn. Wt.
ADOBE / PHOENIX / CHAMPION / ESSICK / ARCTIC CIRCLE WISPERCOOL / FRIGIKING / WILLIAMS / MC GRAW / GOETTL					
▲8301	Side	22 x 22 x 27	Arctic Circle TW2800 / WisperCool WV3000	5	2.0
▲8302	Side	25 x 18 x 28	Champion WV2800 / Essick WV2800 / Marquis WV 2800	5	2.1
▲8326	Side	28 x 28 x 29	ArcticCircle / Arvin / WisperCool 3000 & WV3000 / Goettl H332-A	5	3.4
▲8404	Down	28 x 28 x 29	Arctic Circle 3000 / Goettl D332-A / WisperCool 3000	5	3.9
▲8327	Side	28 x 28 x 32	Alpine RW4000 & S30A; Arctic Circle RC40W / EW445 / ES330G / SS330G / Brisa BW3500 & BH3000 / Frigiking W302 & FS350 / Williams 3000 / WisperCool WV4000	5	3.4
▲8410	Down	28 x 28 x 32	Alpine D30A / Arctic Circle ED330G & SS330G / Brisa BD3000 / Frigiking FD350 / Phoenix WH3302	5	4.0
▲8328	Side	28 x 28 x 34	Arvin WV4000 / Champion 3000 & WV3500 / McGraw 3000 / Marquis 3000 & WV3500 / Phoenix 3000 / Williams 3000	5	3.9
▲8412	Down	28 x 28 x 34	Champ & Marquis 3000 / McGraw 3000 / Williams 3000	5	4.4
▲8335	Side	28 x 28 x 41	Champion & Marquis WV40/43 / McGraw WV4200	5	4.2
▲8418	Down	28 x 34 x 30	Essick N3100D	5	4.2
▲8340	Side	29 x 29 x 36	Arvin WV4500 / Frigiking WV4000 / Phoenix WV 4000	5	3.9
▲8417	Down	30 x 30 x 33	Phoenix DM3300	5	4.8
▲8303	Side	31 x 9 x 27	Phoenix Economy Window WH2902	5	2.0
▲8422	Side	34 x 28 x 36	Brisa BW5500 / Champ WC44 / Essick N41W & N48W / Phoenix WH4402 & WH4802	5	3.9
▲8342	Side	34 x 28 x 40	Champ WC42-WC47-WC49 / Marquis WV4200 & WV4700 & WV4900 / McGraw WV4800	5	4.0
▲8461	Down	34 x 34 x 34	Essick 4300 & 4800	5	5.5
▲8345	Side	34 x 34 x 36	Alpine RW4000 & RW5000 & S45A / Arctic Circle WV4500 & WV4800 & 4300 / Brisa BH4000 & BW4500-5000 / Champ 4001 & WC46/50 & RWC46/50 / Essick N4000S & N4500S / Frigiking W453-W482-FD450 / Goettl H432-A & H482-A / Phoenix HM4800 / Williams 4500 / WisperCool 4000-WV4500-WV5000	5	4.5
▲8429	Down	34 x 34 x 36	Alpine D45A / Arctic Circle ED430G & SD430G / Brisa BD4000/ Champ 4001 / Essick N4300D & N4800D / Frigiking FD450 / Goettl D432-A & D482-A / Phoenix DM4800	5	5.2
▲8350	Side	34 x 34 x 40	Champ 4000 & 4500 / Marquis 4000 / McGraw 4500 / Phoenix 4500 (before 1985) / Williams 4500 (before 1986)	5	4.9
▲8435	Down	34 x 34 x 40	Champ & Marquis 4000-4800 / McGraw 4500 / Phoenix 4500 (before 1985) / Williams 4500 (before 1986)	5	6.1
▲8321	Side	35 x 29 x 41	Champion WV4700 (older model)	5	9.7
▲8438	Down	37 x 37 x 32	McGraw TRL4800 / Phoenix TRL4800	5	5.4
▲8467	Down	37 x 37 x 37		5	6.6
▲8356	Side	37 x 37 x 42	Alpine S65A / Arctic Circle ES630G & SS630G / Brisa BH5000 / Essick N5500S & N6500S / Frigiking FS650 / WisperCool 5500	5	5.6
▲8441	Down	37 x 37 x 42	Alpine D54A / Arctic Circle ED630G & SD630G / Arvin 6500 / Brisa BD5000 / Essick N5600D & N6600D / Frigiking FD650 / WisperCool 6500	5	7.1
▲8361	Side	37 x 37 x 45	McGraw 6500	5	6.0
▲8446	Down	37 x 37 x 45	McGraw 6500	5	7.2
▲8373	Side	38 x 38 x 40	Phoenix HM6800 / Williams 6500	5	5.8
▲8479	Down	38 x 38 x 40	Phoenix DM6800 / Williams 6500	5	7.0
▲8374	Side	38 x 38 x 44	Phoenix 6500 (before 1985)	5	6.1
▲8485	Down	38 x 38 x 44	Phoenix 6500 (before 1985)	5	7.8

MasterCool®, Arctic Circle®, are registered trademarks of AdobeAir, Inc. Arvin® is a registered trademark of Arvin Industries, Inc. Phoenix™, Frigiking™, AeroCool™ are trademarks of Phoenix Mfg. Inc. Champion™, UltraCool™ are trademarks of Champion Cooler Corp. Essick™, ComfortCool™ are trademarks of Essick Air Products.



EVAPORATIVE COOLER PARTS

COOLER COVERS

Dial P/N	Type	W x D x H	Size Reference	Ctn. Qty.	Ctn. Wt.
ADOBE / PHOENIX / CHAMPION / ESSICK / ARCTIC CIRCLE / WISPERCOOL / FRIGIKING / WILLIAMS / MC GRAW					
▲8473	Down	39 x 39 x 31	Champ RLD 43/48/54 & 44/49/55	5	6.0
▲8448	Down	40 x 40 x 43	Champ & Marquis 5000-5500-6500 / Goettl D582-A & D682-A	5	7.6
▲8367	Side	40 x 40 x 45	Champion & Marquis 5000-5500-6500 / Goettl H582-A & H682-A / Williams 6500 (before 1988)	5	6.7
▲8450	Down	40 x 40 x 45	Williams 6500 (before 1988)	5	8.0
▲8455	Down	41 x 41 x 38	Champion RLD 55/65/72 / 56/66/73	5	7.5

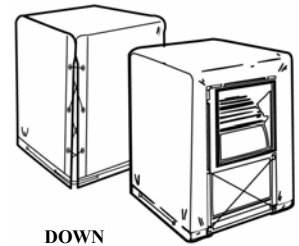

DOWN

SIDE

TRADEWINDS / BREEZAIR					
▲8407	Side	39 x 39 x 36	Tradewinds TS451	5	4.7
▲8405	Down	41 x 41 x 29	Tradewinds TC451	5	8.0
▲8406	Down	45 x 45 x 34	Tradewinds TC571	5	8.6
▲8470	Down	46 x 46 x 26	BreezAir EM137-145-155	5	5.2
▲8471	Down	46 x 46 x 34	BreezAir EM265-275	5	5.9



TRADEWINDS

MASTERCool / AEROCool / ULTRACool / COMFORTCool / ASTRO AIR					
▲8372	Side	42 x 26 x 33	MasterCool Window MW5500	5	5.2
▲8399	Side	42 x 43 x 28	MasterCool EC440 / MC44 / CMC441-442	5	5.0
▲8400	Down	42 x 43 x 28	Astro-Air MD430 & MD440 / MasterCool EC430 / MC43 / CMC431-432	5	5.8
▲8401	Side	42 x 43 x 28	AeroCool 4000 & AH4800 & PH4801-4231 / AeroCool Trophy TH4800	5	5.0
▲8402	Down	42 x 43 x 28	AeroCool 4400-4800 / AD4800 / AeroCool Pro PD4230 & PD4800 & Trophy TD4800 (split corner for junction box)	5	5.8
▲8377	Side	42 x 43 x 34	MasterCool EC640 / MC64 / CMC641-642	5	5.6
▲8487	Down	42 x 43 x 34	Astro-Air MD630-640 / MasterCool EC630 / MC63 / CMC631-632	5	6.3
▲8379	Side	42 x 45 x 28	ComfortCoolSI500S / UltraCool ASA50	5	5.0
▲8483	Down	42 x 45 x 28	ComfortCool SI500D / UltraCool ADA50	5	5.2
▲8378	Side	42 x 45 x 35	AeroCool ACD 5800-6800 / AeroCool Pro PH6800 / PH6230 / Trophy TH6800 (split corner for junction box)	5	5.9
▲8490	Down	42 x 45 x 35	AeroCool ACD 5800-6800 / AeroCool Pro PD6230-6231-6800-6801 / AeroCool Trophy TD6800 (split corner for junction box)	5	7.1
▲8383	Side	42 x 47 x 28	MasterCool II HP (w/12" pad) HC44/HPC440 / CHC441-442 / AeroCool Trophy TH4812	5	5.8
▲8488	Down	42 x 47 x 28	AeroCool Trophy TD4812 / MasterCool II HP (w/12" pad) HC43 / HPC430 / CHC431-432	5	6.0
▲8376	Side	42 x 47 x 33	MasterCool II HP (w/ 12" pad) HC64 / HPC640 / CHC641-642	5	6.0
▲8480	Down	42 x 47 x 33	MasterCool II HP (w/ 12" pad) HC63 / HPC630 / CHC631-632	5	7.2
▲8380	Side	42 x 48 x 35	ComfortCool SI700S / UltraCool ASA70	5	5.9
▲8484	Down	42 x 48 x 35	AeroCool Trophy TD6812 / Astro-Air SIPB-335 & SIPB45 / ComfortCool SI700D / UltraCool ADA70	5	7.1



BREEZAIR



8401 / 8402 / 8378 / 8490



SINGLE INLET SIDE



SINGLE INLET DOWN

AIREZE ROUND

Dial P/N	Type	Size Reference	Ctn Qty.	Ctn Wt.
▲8555	Side	34 D x 33 H Aireze F2 Window 4000-4500 & F2 Sidedraft 3500-4000	5	3.5
▲8645	Down	34 D x 33 H Aireze F2 Downdraft 3500-4000	5	5.7
▲8556	Side	40 D x 33 H Aireze F3 Window 4600-5000 & F3 Sidedraft 4400-4800	5	3.8
▲8646	Down	40 D x 33 H Aireze F3 Downdraft 4400-4800-5400	5	4.8
▲8557	Side	45 D x 36 H Aireze F4 Window 6000-7000 & F4 Sidedraft 5800-6800	5	4.9
▲8647	Down	45 D x 36 H Aireze F4 Downdraft 5800-6800-7400	5	5.7
▲8648	Down	54 D x 36 H Aireze F5 Downdraft 8000-9000	5	7.2



AIREZE



INDUSTRIAL/COMMERCIAL

Dial P/N	Type	W x D x H	Size Reference	Ctn Qty.	Ctn Wt.
▲8531	Side	42 x 42 x 54	Arvin/Champion/Essick 7500-8500; Goettl H750-850; McGraw; Phoenix H-7800 & H-8800	3	8.8
▲8540	Down	42 x 42 x 54	Arvin/Champion/Essick 7500-8500; Goettl D750-850; McGraw; Phoenix D-7800 & D-8800	3	11.5
▲8533	Side	50 x 50 x 54	Arvin/Champion/Essick 10,500-12,500; Goettl H1480; McGraw	3	11.3
▲8542	Down	50 x 50 x 54	Arvin/Champion/Essick 10,500-12,500; Goettl D1480; McGraw	3	13.3
▲8545	Down	52 x 52 x 52	Phoenix D1424 (10,5000-12,5000)	3	13.4
▲8535	Side	62 x 62 x 62	Arvin/Champion/Essick 14,000-21,000; Goettl H2280; Phoenix H-2128	3	18.5
▲8544	Down	62 x 62 x 62	Arvin/Champion/Essick 14,000-21,000; Goettl D2280; Phoenix D-2128-2130-2231	3	19.5



INDUSTRIAL



VENTILATOR

TURBINE VENTILATOR

Dial P/N	Description	Ctn Qty.	Ctn Wt.
▲8551	Turbine Cover Fits 12" turbines with external support structure; fits 14" turbines with internal support structure	6	7.5

PILLOW DUCT PLUG

▲7626	Pillow Duct Plug White R-24 insulated Pillow covered with a sewn reinforced vinyl.	6	6.6
-------	---	---	-----

TIE DOWN STRAPS AND CORDS

▲8237	E-Z Strap™ Cover Two 15 Ft. 1" Heavy Duty Sun Resistant straps Reduce Heat Loss	10	7.0
▲8235	Tie Down Cord 50 Ft. of Heavy Duty Sun-Resistant Cord to secure cover from high winds.	10	1.2

Reduces heat loss through cooler duct



PILLOW DUCT PLUG



E-Z STRAP™ COVER TIE DOWNS

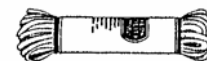

COOLER
TIE DOWN CORD

UP-DUX® / MULTI-PITCH® / VIBE-RX® / MAXaire™



PN 7606
Economy KD Ceiling Vent



PN 7607
Extended Height Top-R Ceiling Vent



PN 7608
Low Profile Assembled Ceiling Vent



PN 7610
Deluxe, Standard Height



PN 76114
Replacement Grille

PN 76112
Replacement Thermo-Panel No. 96500 (3 per)



Standard Galvanized

Slide-in winterizer damper is included

PN 78317
PN 78318
18" Roof Jack w/Slide-in Damper - 4500 CFM
20" Roof Jack w/Slide-in Damper - 6500 CFM

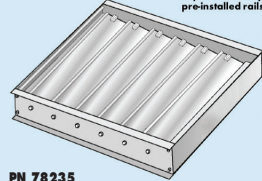

Slides into Multi-Pitch™ roof jack on factory pre-installed rails

PN 78235
PN 78236
18" Maxaire Barometric Damper 3000-4500 CFM Downdraft
20" Maxaire Barometric Damper 5500-6500 CFM Downdraft

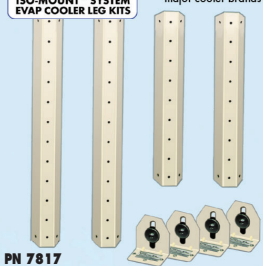

Color compatible with major cooler brands

PN 7817
PN 7818
Round Corner Leg Kit 4/12 Pitch
Round Corner Leg Kit 6/12 Pitch

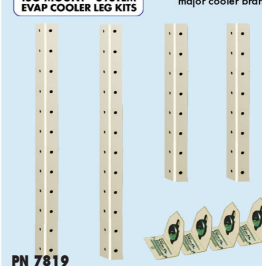

Color compatible with major cooler brands

PN 7819
PN 7820
Square Corner Leg Kit 4/12 Pitch
Square Corner Leg Kit 6/12 Pitch

PART #	DESCRIPTION	PKG.	CARTON QTY.	CARTON WT.
▲ 7606	Up-Dux® Economy KD Ceiling Vent (TPS-101)	Box	6	22.0
▲ 7607	Up-Dux® Extended Height Top-R (DL-101-T)	Box	6	42.5
▲ 7608	Up-Dux® Low Profile Assembled (LP-101)	Box	6	19.0
▲ 7610	Up-Dux® Deluxe, Standard Height (DL-101)	Box	6	30.0
▲ 76112	Up-Dux® Replacement Thermo-Panel #96500 (3 per)	Bag	1	.5
▲ 76114	Replacement Up-Dux® Grilles	Box	12	9.0
▲ 7817	Vibe-RX® Round 4/12 Leg Kit (VRX-R4D18)	Box	6	42.0
▲ 7818	Vibe-RX® Round 6/12 Leg Kit (VRX-R6D16)	Box	6	55.0
▲ 7819	Vibe-RX® Square 4/12 Leg Kit (VRX-S4D18)	Box	6	42.0
▲ 7820	Vibe-RX® Square 6/12 Leg Kit (VRX-S6D16)	Box	6	55.0
▲ 78235	18" MAX AIRE™ Barometric Damper 3000-4500 Downdraft*	Box	1	4.7
▲ 78236	20" MAX AIRE™ Barometric Damper 5500-6500 Downdraft*	Box	1	5.7
▲ 78317	18" Multi-Pitch™ Roof Jack w/Slide-in Damper Galvanized 4500 (C1775JS)	Box	1	13.0
▲ 78318	20" Multi-Pitch™ Roof Jack w/Slide-in Damper Galvanized 6500 (C1975JS)	Box	1	16.0

*Fits Mission Mfg. jacks

Dial has the coolest products!



Attractive Retail Product Displays



In addition to the pegboard product display, Dial offers a complete casecut program.



Founded in 1965, today Dial Manufacturing, Inc. boasts the most complete line of evaporative cooling parts and outdoor mist system components available in either market. In addition to supplying a large number of domestic customers, Dial also sells products in Mexico, Central and South America, in the Middle East, and in Europe. With its headquarters in Phoenix, Arizona, Dial is owned and managed today by the same family who started the business more than thirty years ago, which provides both continuity with the past and stability for the future.

DIAL MANUFACTURING, INC.

25 South 51st Avenue • Phoenix, AZ 85043 • (602) 278-1100 • (800) 350-DIAL • Fax (602) 278-1991 • Fax (800) 370-3299