



PROFESSIONAL IRRIGATION PRODUCTS

PLANNING AND INSTALLATION GUIDE

Step-By-Step Instructions for Automatic Irrigation



Give Your Yard Exactly the Water it Needs

Every landscape is unique. Foliage varies and so do patterns of sun and shade. That's why different parts of your yard need different amounts of water at different times. Your Irritrol automatic sprinkler system lets you divide your yard and garden into separate areas based on the individual watering needs. Once you've installed your system, all you need to do is set the watering schedule that's right for each area. Your Irritrol components automatically do the rest — week after week.

The Benefits of an Irritrol Irrigation System

You will Save Time

Once you have set your system controller, your Irritrol automatic sprinkler system takes care of the rest. It remembers precisely how much to water and how often, for each area of your yard. So you have the freedom to come and go as you please, knowing that your lawn and garden are being well cared for.

You will Save Water

A full range of Irritrol sprinklers and valves lets you tailor watering to the exact needs and layout of your yard. So you water efficiently without puddling or dry spots. And automatic irrigation lets you conveniently water in the early morning when wind and evaporation are lowest, or shut off water when it is raining outside.

You will Improve Your Home's Value

An automatic sprinkler system can add thousands of dollars to the value of your property. It is a valuable labor saving feature in any home. And by helping keep your lawn and garden greener and healthier, it protects your landscaping investments and makes your home more desirable.

You will Water Precisely When and Where It is Needed

Use different spray patterns to customize watering to the precise size and shape of your yard. Then set your automatic controller for how long and how often to water. You will create a flexible watering schedule that's right for the special needs of every part of your landscape.

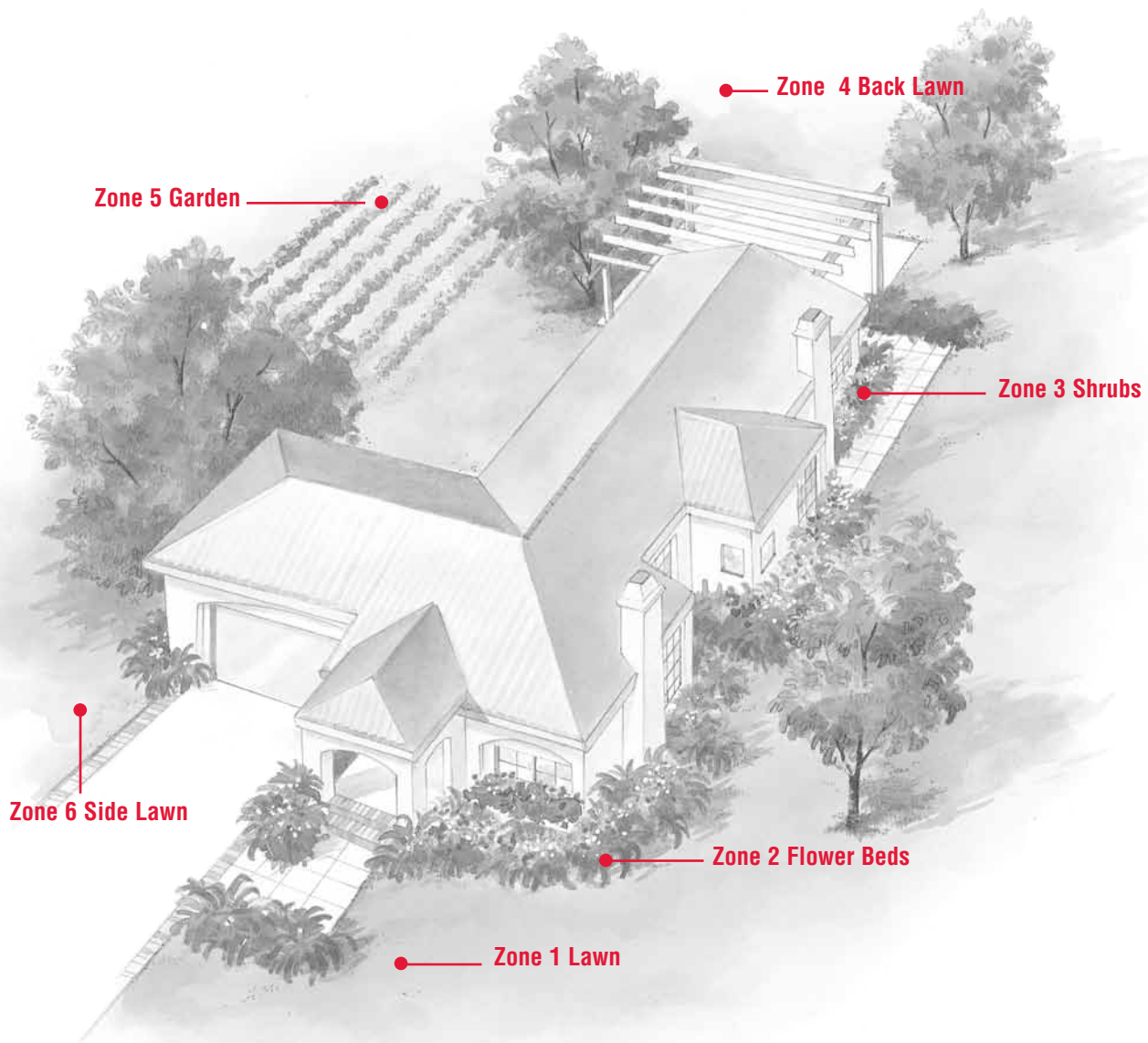

We Are Here to Make it Easy.

Planning your Irritrol automatic sprinkler system means following a few simple directions. This guide lays out the steps you will take. Just follow them one by one to quickly plan and assemble your system. And if you have any questions or need the help of a professional for installation, call your local Irritrol dealer.

Step 1. Gather the Information

- a. Before you begin3
 - Determining how much water is available for your sprinkler system.
- b. The components you will use . . .4
 - Identifying the different parts that make up your system.

Step 2. Plan the Layout

- a. Planning your installation5
 - Choosing types and locations of sprinkler heads
 - Dividing sprinkler heads into zones controlled by valves
 - Choosing an irrigation controller and watering schedules
- b. Sketching your layout8

Step 3. Install the System

- a. Assembling pipe10
 - Tips for layout and assembly
- b. Connecting valves,12
 - connecting pipe and flushing the system
- c. Attaching sprinkler heads and . .13
 - connecting to pipe
- d. Installing controller, wiring . . .14
 - valves for automatic control

Additional Tips

- a. Special considerations,14
 - converting manual systems to automatic and using an external pump
- b. Operating tips,15
 - maintenance, troubleshooting and operating tips

Before You Begin

CHECK LOCAL CODES AND PERMITS.

Call your water company or the proper municipal authority to find out about any building codes or permits required for the installation of underground sprinkler systems. They can tell you about local codes for backflow prevention to protect your household water supply from contamination and advise you on where in the system to locate it.

WARNING

 Personal injury may result from trenching over buried power or gas lines. Before digging or trenching, check with your local utility companies to identify any buried cables, pipe or gas lines!

WATER CAPACITY DETERMINES THE SIZE OF YOUR SYSTEM.

How many sprinklers your system can run at one time depends on how much water your home can supply. In this section, you will make a few simple measurements to determine your “water capacity.”

Determine Your Water Meter Size

Water meters are usually 5/8”, 3/4” or 1” in size. You will probably find this number stamped on the side of the water meter or printed on your water bill. If not, your local water company can give you the answer. Write your water meter size here_____.

Determine Your Service Line Size

Your service line is the pipe that runs from your water meter to your house, or into your house from the basement if the meter is located there. Wrap a tape measure or a piece of string around this pipe and measure the length needed to encircle it.

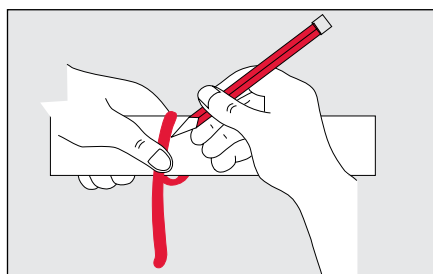

Then look up the diameter of the pipe in the table below. Write your service line size here_____. For maximum water pressure to your sprinkler system, all pipes from the service line to the valves (as well as the valves themselves), should be at least this size.

Pipe measurement	27/8"	33/8"	33/8"	45/8"	53/8"
Size of PVC or Galvanized		3/4"	1"	1 1/4"	
Size of Copper		3/4"	1"		

Determine Your Water Pressure

For service lines without pressure regulation, your water pressure is measured in pounds per square inch (psi) at an outside faucet near where you will locate your control valves. A pressure gauge makes it easy to make this reading. Just make sure all water sources both inside and outside the house are turned off. Simply attach the gauge to an outside faucet and open the faucet fully. If your service line has a pressure regulator, or you can't get a gauge, ask your water company for the average water pressure at your meter. Write your water pressure here: _____PSI.

If your water comes from a pump Check with your pump dealer or a pump service company, or refer to your pump owner's manual to determine the pressure (psi) and flow (gpm) of your pump. These figures are determined by your pump type and capacity and the distance that you are lifting the water. Write these figures here: Pressure _____ PSI at _____GPM.

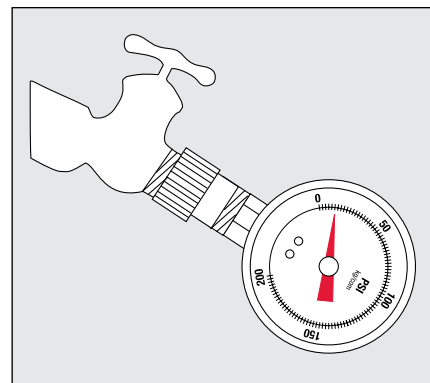

Pressure Gauge

READ YOUR WATER CAPACITY FROM THE CHART

Use the information you have just obtained to find your water capacity on the chart below. For example, a 5/8" meter and 3/4" service line at 55 psi yields a water capacity of 10.0 gallons per minute (gpm). Write your home's water capacity here _____.

Determining Gallons Per Minute

Size Of	Water Pressure (PSI)										
Water Meter	30	35	40	45	50	55	60	65			
Service Line	Gallons Per Minute (GPM)										
5/8" 1/2"	2.0	3.5	5.0	6.0	6.5	7.0	7.5	8.0			
5/8" 3/4"	3.5	5.0	7.0	8.5	9.5	10.0	11.0	11.5			
3/4" 3/4"	5.0	7.0	8.0	9.0	11.0	12.0	14.0	15.0			
3/4" 1"	7.5	10.0	11.5	13.5	15.0	16.0	17.5	18.5			
1" 3/4"	6.0	7.5	9.0	10.0	12.0	13.0	15.0	16.0			
1" 1"	9.0	12.0	13.5	17.0	19.0	20.0	21.0	21.0			

NOTE:

- For water pressures greater than 70 psi, use 65 psi figures.
- If pressure exceeds 80 psi, install pressure regulator.
- If your service is galvanized steel, use 65% of the gpm figures shown.

Controller activates system automatically

The Components You Will Use

All Irritrol automatic irrigation systems use an automatic controller, valves, sprinklers, and pipe.

CONTROLLERS

A controller or "clock" tells your system's valves on which days to water, how long to run, and when to start. Various models offer programming options that let you customize day schedules, run times and start times, to the unique needs of different parts of your yard.

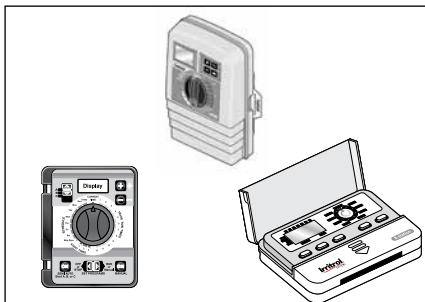

VALVES

A valve supplies water to sprinkler heads along a dedicated section of pipe. Electrically controlled by your Irritrol controller, each valve turns off and on to deliver precisely the right amount of water to a specific area of your yard.

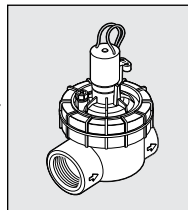

PIPING

PVC pipe connects your service line with your control valves. Either PVC or poly pipe may be used between the valves and sprinkler heads if local codes permit. Check your local codes for correct usage of poly pipe.

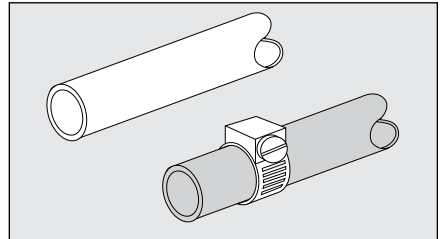

SPRINKLERS

You may select from a complete line of sprinklers including fixed sprays, gear-driven rotors, shrub heads and bubblers to provide the right amount of water in the right pattern for your specific areas. You conserve water and grow a

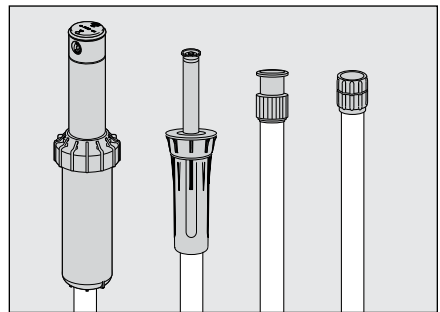

healthier yard by designing a system that delivers just the right amount of moisture, precisely where you need it.

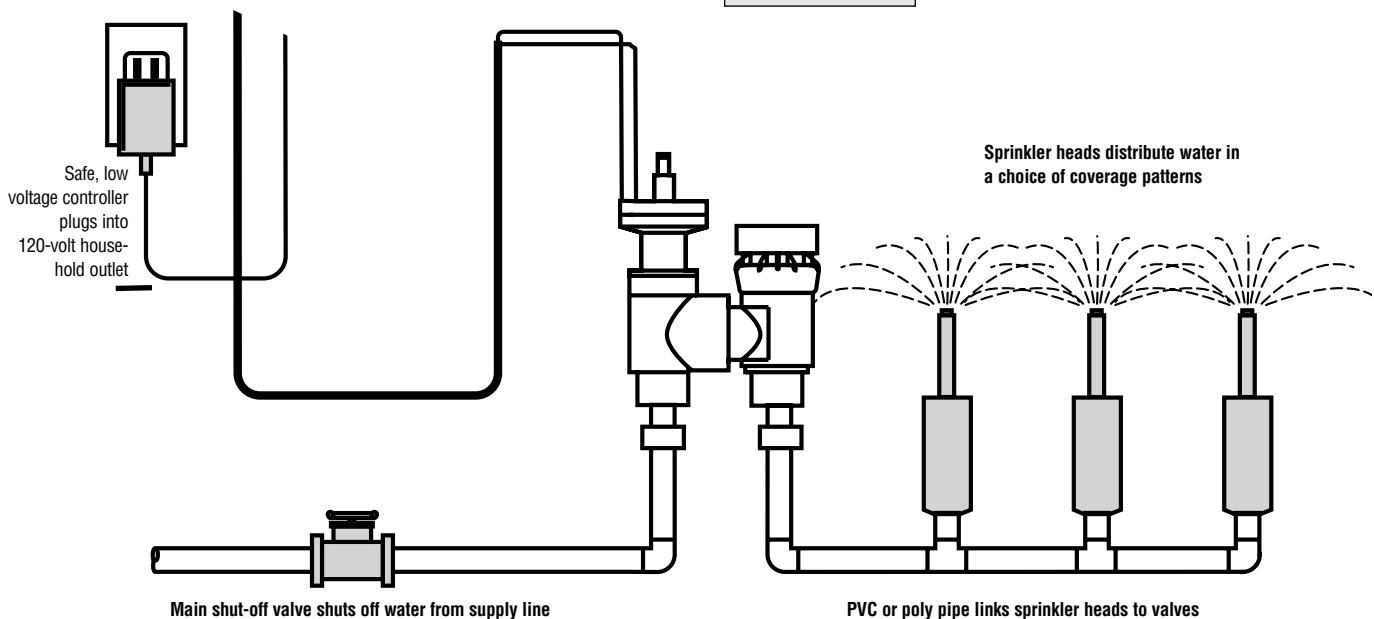

Planning Your Installation

Delivering water where it is needed

The first step in laying out your system is to decide which areas you want to water, and the kind of spray patterns these areas require. You will choose sprinkler heads appropriate for the size and shape of the area, and arrange the sprinkler heads so that their spray patterns overlap for uniform coverage.

Plot the locations of areas to water

Using the grid on page 10 of this guide, plot the outlines of your home and garden areas. Include walks, driveways and patios. Use a tape measure for accuracy, and make sure all the areas match the scale of the grid. Divide up lawn areas into large squares and rectangles to make it easier to group sprinkler heads. And label each area according to type of foliage (e.g. lawn, shrubs, flower bed, etc.)

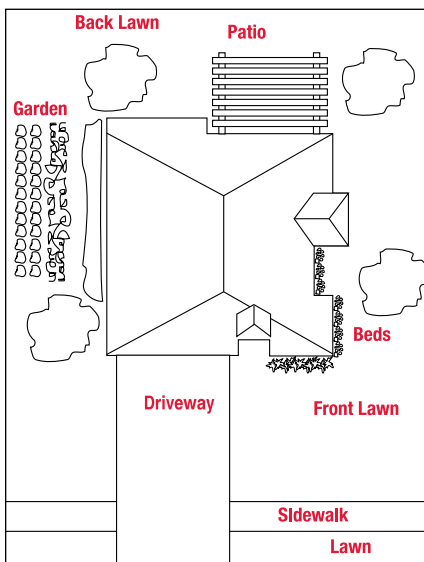

Choose the right types of sprinklers

Refer to the information and selection chart on the next page. For each type of foliage you have identified, you will note that there is a specific type of sprinkler recommended, with various coverage patterns to choose from. The different kinds of sprinkler heads ensure that each kind of foliage is watered in the most appropriate manner.

ROTORS

Irritrol's 550R gear-driven rotor is designed for watering medium to large lawn areas. Rotors provide excellent watering coverage when spaced 25' to 50' from each other, based on nozzle size and available pressure. The rotor's "closed-case" design provides quiet operation and less sprinkler maintenance because dirt and debris are unable to reach the inside of the sprinkler.

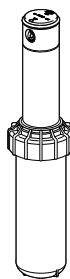

FIXED SPRAYS

Irritrol pop-up sprays provide even water distribution and a low spray angle which minimizes evaporation and wind drift. Fixed sprays do not rotate like rotors; they simply pop up and spray water in a defined pattern or arc. Using a screwdriver, the radius can be adjusted and the spray pattern can be fine tuned in precise increments after installation. (See next page for radius and spray pattern information.) They feature a heavy-duty stainless steel retraction spring to prevent "stick-ups", a removable filter screen for easy cleaning, and an exclusive wiper seal that blocks damaging grit that can cause leaking and unreliable pop-up action.

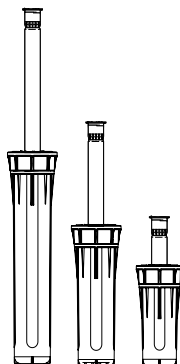

SHRUB HEADS

Shrub heads are designed to be mounted on 1/2" risers for use in shrub and ground cover areas. Irritrol shrub heads utilize the same nozzle design and patterns as Irritrol fixed-sprays to conserve water and ensure uniform performance.

ADJUSTABLE FLOOD BUBBLERS

Exclusive Irritrol design adjusts fully from 1.36 to 5.90 gpm to tailor watering to specific plant needs. Removable filter screen prevents clogging. Attaches to any 1/2" riser.

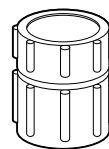

Position Heads for Uniform Coverage

Properly positioning your sprinkler heads is very important for correct watering. Referring to the maximum spacing guidelines in the selection chart, begin to sketch in the sprinkler locations on your grid. Start with the largest area first, and complete one area at a time. Use a compass to help draw circle and part circle patterns. You may need to adjust spacing to achieve the most uniform coverage; use the suggested distances in the chart on the next page as a place to start. Spacing should be no further apart than 50% of the diameter of the sprinkler throw (i.e. head-to-head spacing: throw from one sprinkler hits the sprinkler on either side of it).

Begin by placing quarter circle sprinklers in the corners of the lawn areas. Overlap coverage as shown by adding half circle sprinklers along the sides, and then if needed, full circle heads in the center. Use rectangular-pattern heads to water narrow strips.

Finally, add sufficient spray heads and bubblers to soak flower beds, planters and shrub areas.

Sample Drawing

(note "head-to-head" coverage)

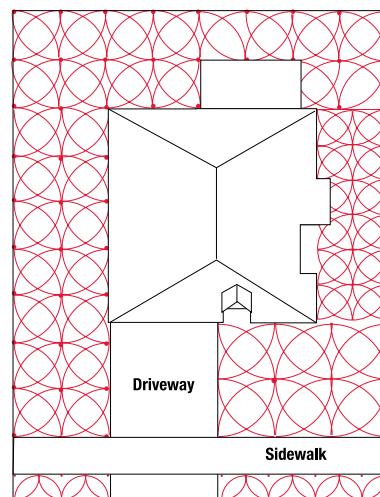







• Red dot indicates sprinkler placement.

The different PSI ranges listed on these charts are based upon the **Working pressure** of the sprinkler heads. This is not the same as the **Static Water Pressure** which you measured when you determined your water pressure earlier. The normal operating pressure range of 30 PSI is highlighted on the charts for your use.

Pop-Up Sprinklers

For Small-to-Medium Lawn Areas, 5' to 15'
Shrub Heads

For Shrub and Ground Cover Areas, 5' to 15'

Pattern	Models	PSI	Radius (feet)	Flow GPM
	(4")	20	13'	3.05
	(3")	30	15'	3.70
	(Shrub)	40	17'	4.35
	(4")	20	13'	1.53
	(3")	30	15'	1.85
	(Shrub)	40	17'	2.17
	(4")	20	13'	0.76
	(3")	30	15'	0.93
	(Shrub)	40	17'	1.08
	(4")	20	3' x 28'	1.10
	(3")	30	4' x 30'	1.21
	(Shrub)	40	5' x 32'	1.35
	(4")	20	3' x 14'	0.52
	(3")	30	4' x 15'	0.61
	(Shrub)	40	5' x 17'	0.70
	(4")	20	3' x 28'	1.10
	(3")	30	4' x 30'	1.21
	(Shrub)	40	5' x 32'	1.35
	(4")	25	15'	0.88
	25 to 360 degrees (3")	25	15'	1.75
	(Shrub)	25	15'	3.50

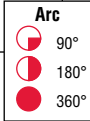

Match the shape and size of your yard with these patterns

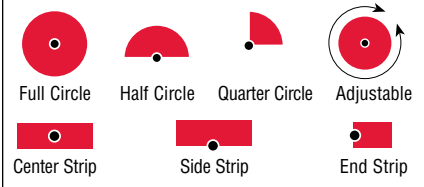

Adding Valves to Your System

Divide Your Sprinklers into Zones (Groups)

Now it is time to divide your sprinklers into groups, or Zones. A Zone is simply a group of sprinkler heads connected together with pipe controlled by a single valve. Each valve is electrically controlled by the controller.

The basic idea is to group together areas of your yard that have the same watering needs, so the sprinkler heads supplying each area will water on the same schedule. This lets you tailor watering needs to the different areas of your yard.

Rotors

For Medium-to-Large Areas, 25' to 48'

Nozzle	Pressure psi	Radius ft.	Flow GPM	Precip. in/h	Precip. in/h ▲
1.5	25	33	1.15	0.20	0.23
	35	34	1.38	0.23	0.27
	45	35	1.59	0.25	0.29
	55	35	1.74	0.27	0.32
	65	36	1.88	0.28	0.32
2.0	25	35	1.45	0.23	0.26
	35	36	1.80	0.27	0.31
	45	37	2.12	0.30	0.34
	55	37	2.30	0.32	0.37
	65	37	2.58	0.36	0.42
2.5	25	35	1.75	0.28	0.32
	35	36	2.20	0.33	0.38
	45	37	2.55	0.36	0.41
	55	37	2.80	0.39	0.45
	65	37	3.05	0.43	0.50
3.0	25	36	2.20	0.33	0.38
	35	38	2.60	0.35	0.40
	45	40	3.05	0.37	0.42
	55	40	3.52	0.42	0.49
	65	40	3.80	0.46	0.53
4.0	25	37	2.95	0.41	0.48
	35	40	3.55	0.43	0.49
	45	42	4.10	0.45	0.52
	55	42	4.45	0.49	0.56
	65	43	4.85	0.50	0.58
5.0	25	39	3.75	0.47	0.55
	35	41	4.50	0.52	0.60
	45	43	5.10	0.53	0.61
	55	45	5.75	0.55	0.63
	65	45	6.10	0.58	0.67
6.0	25	39	4.20	0.53	0.61
	35	43	5.20	0.55	0.63
	45	46	6.05	0.60	0.69
	55	47	6.65	0.58	0.67
	65	48	7.25	0.61	0.70
8.0	25	36	5.75	0.85	0.99
	35	43	7.10	0.74	0.85
	45	47	8.05	0.70	0.81
	55	48	8.95	0.75	0.86
	65	50	9.70	0.75	0.86

Flood Bubbler

For Flower Beds, Shrubs, Planters and Trees

Pattern	Model	PSI	Radius (feet)	Maximum Spacing	Flow GPM
 Circle bubble	533	75 max.	Up to 2'	n/a	1.36-5.90

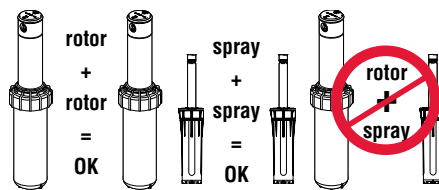

Use Separate Zones for Sun & Shade

It is a good idea to group sprinklers in sunny and shady areas separately, so that you can tailor your watering schedule to give each area the water it requires.

Do not mix rotors, pop-ups, shrub heads or bubblers in THE SAME ZONE.

Each type of sprinkler applies water at a different rate. For economical and efficient watering, the same type of head must be used throughout a zone.

Add Up The Flow for each Zone

Referring to the earlier chart, write the flow (in liters or gallons per minute) requirement next to each sprinkler head on your layout. When you group the heads into Zones, add up the gpm figures for all the heads in each Zone.

Make Sure Flow is Less Than Water Capacity

Compare the total flow for all heads in each Zone with the water capacity you determined on page 4. The total lpm/gpm for each Zone must be less than your home's water capacity for proper operation.

Group valves into Manifolds

You will use one valve for each Zone. For convenience, it helps to locate these valves together in a grouping called a manifold. Choose an accessible spot away from heavy foot traffic, and as close as possible to your service line. You may want to locate one manifold in your front yard and one in back.

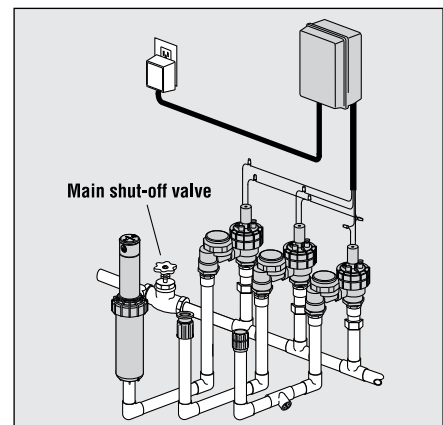

Select the right Valve For Your System

Valves come in three basic types. All valves turn groups of sprinkler heads on and off in response to either electrical signals from your controller or manual operation. The type of valves you use depends on local codes and the source of your water supply.

1. Anti-Siphon Valves

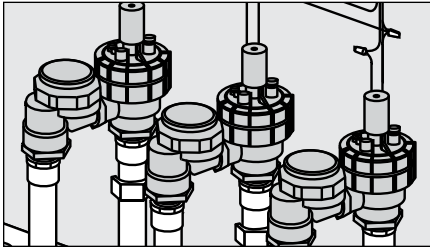

These valves have a built-in backflow prevention device to prevent sprinkler water from flowing back into your home water supply and possibly contaminating it. Anti-siphon valves should be installed 6" to 12" above the highest head, or according to local codes.

2. In-Line valves

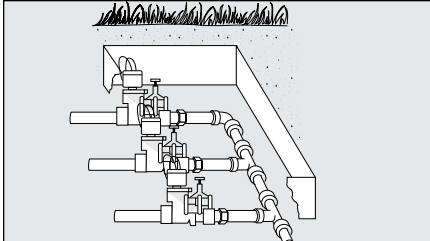

These valves are primarily used with wells, or where codes require a separate backflow-prevention device. They're usually installed below ground and protected by a valve box.

3. Manual valves

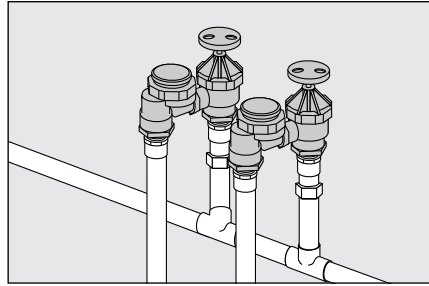

Used for systems without an automatic controller, these valves turn on and off with a simple twist of the handle. They can accept an automatic valve adapter if you decide to add a controller later.

Now Lay Out Your Pipe

The last step in your system layout is connecting the service line, valves and sprinkler heads with pipe. To minimize pressure loss, use the fewest number of turns. Several branch lines, rather than a longer run with multiple turns, can accomplish this. If your sprinkler layout requires long runs of pipe (over 100') use one pipe size larger than the valves.

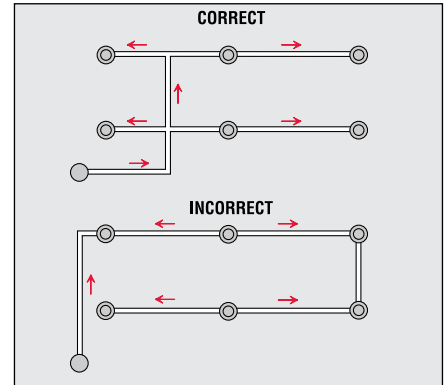

PIPE LAYOUT:

Use several branch lines and the fewest number of turns

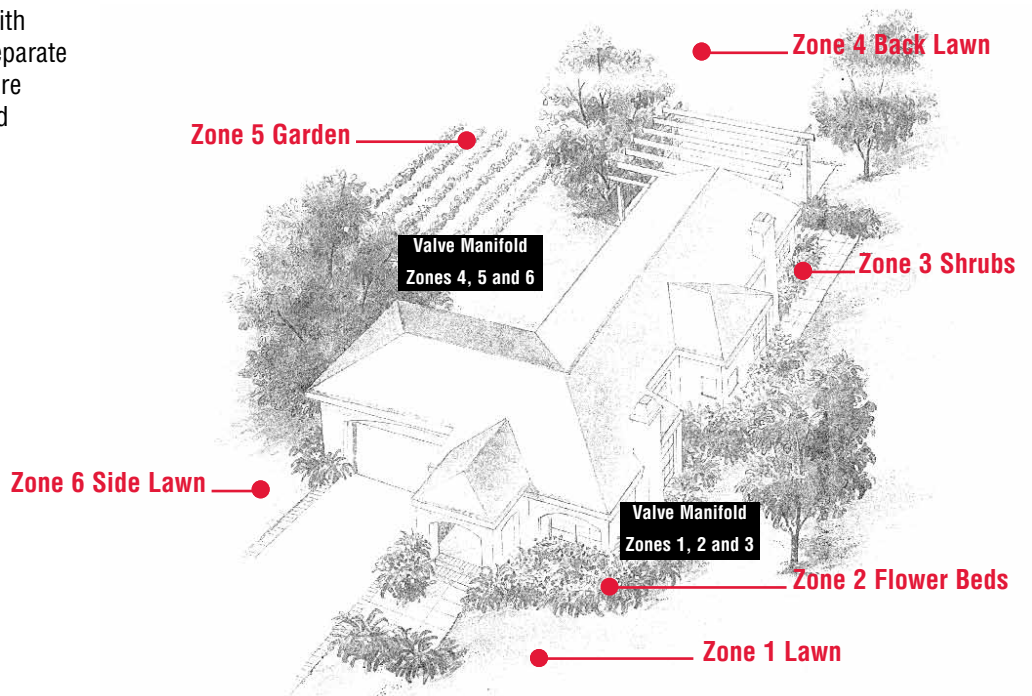

Choosing an Automatic Controller

Select the right features for your yard

The sprinkler controller is the brain of your automated watering system. It lets you “control” the water supply to different parts of your lawn and garden with precisely the water they require, exactly when they require it. While all Irritrol controllers perform this function, some models offer more flexibility than others.

Zone Options

Lawns, shrubs, flower beds and other foliage often need different amounts of water. You can tailor the water delivered to different parts of your yard by assigning a different watering run time to the sprinkler heads controlled each valve.

Irritrol controllers let you divide your yard into as many as twelve zones, depending on the model. The greater the variety of foliage in your yard, or the possibility you will expand your system later, the more zones your controller should have.

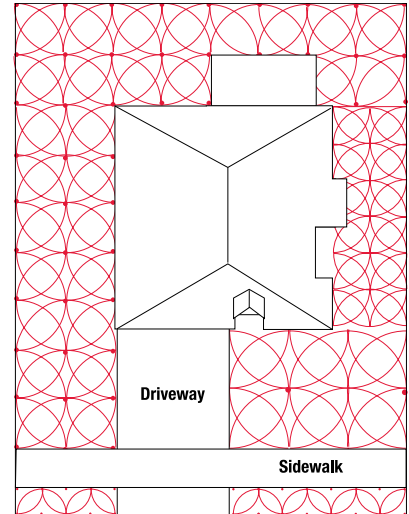

Your Sprinkler System Plan

Sketching Your layout

- Carefully measure your yard, then use a pencil to sketch each area, using the grid scale of one small square per square foot, and one large square per 10 or 20 square feet.
- Make sure you show the outlines of buildings, patio, sidewalk, driveway, concrete slabs, etc.
- Mark locations of all lawn areas, trees, shrubs, ground cover and garden beds.
- Divide lawn areas into large rectangles to help group sprinkler heads.
- Note the locations of your water meter and service line.
- If your service uses a pump, mark the locations of the pump and well.
- Plot sprinkler head locations and note gallons-per-minute requirement for each.
- Group sprinkler heads into zones, using a different colored pencil for each zone.
- Finally, sketch the layout of pipes and valves, as described in the preceding pages of this guide.

Controller Comparison

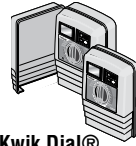

Features	Rain Dial®	Kwik Dial®
Number of Zones/Stations	6, 9 or 12	4, 6, 9 or 12
Indoor Models	Yes	Yes
Outdoor Models	Yes	Yes
No. of Watering Programs	3 (3rd functions as a “loop cycle”)*	3 (independent)
No. of Start Times per Program	3 for programs A & B; program C offers start & end times	3 (independent)
365 Day Calendar Scheduling	Yes	Yes
Water Time Lengths	1 min. to 4 hrs.	1 min. to 4 hrs.
Climate Logic® Weather Sensor Compatible	Yes	Yes
Programmable Prior to Installation	Yes	Yes
Variable Time Each Zone	Yes	Yes
Rain Sensor Capability	Yes	Yes
Manual or Auto Start	Yes	Yes
Self-guided Programming	Yes	Yes
Flip Cover to Hide/Protect Display	Outdoor Model Only	Outdoor Model Only
Master Valve Circuit For Pump Start	Yes	Yes
Battery Backup	Yes	Yes
Test Program (all stations)	No	Yes
Remote Control Ready	No	Yes
Diagnostic Circuit Breaker	Yes	Yes
Multiple Language Display	Yes (embedded in software)	Yes (embedded in software)

* Loop cycle is ideal for drip applications or seed germination

All indoor Irritrol controllers feature plug in transformer and safe low-voltage design.

Pump start relays

If your water supply requires a pump, you will need to include an automatic pump start relay in your system. Most Irritrol controllers are equipped to activate this relay to permit fully automatic watering (see chart above). For installation tips see page 13.

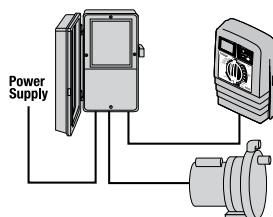

You may also need:

- Knife
- Hammer
- Shovel
- Wooden Stakes
- Pipe Wrench
- Pliers
- PVC solvent cement, primer and rags
- 1" pipe clamps if using poly piping
- Line marking paint (for marking trenches)
- PVC cutter
- String
- Screwdriver
- Pipe Plugs
- Electrical Tape
- Tape Measure







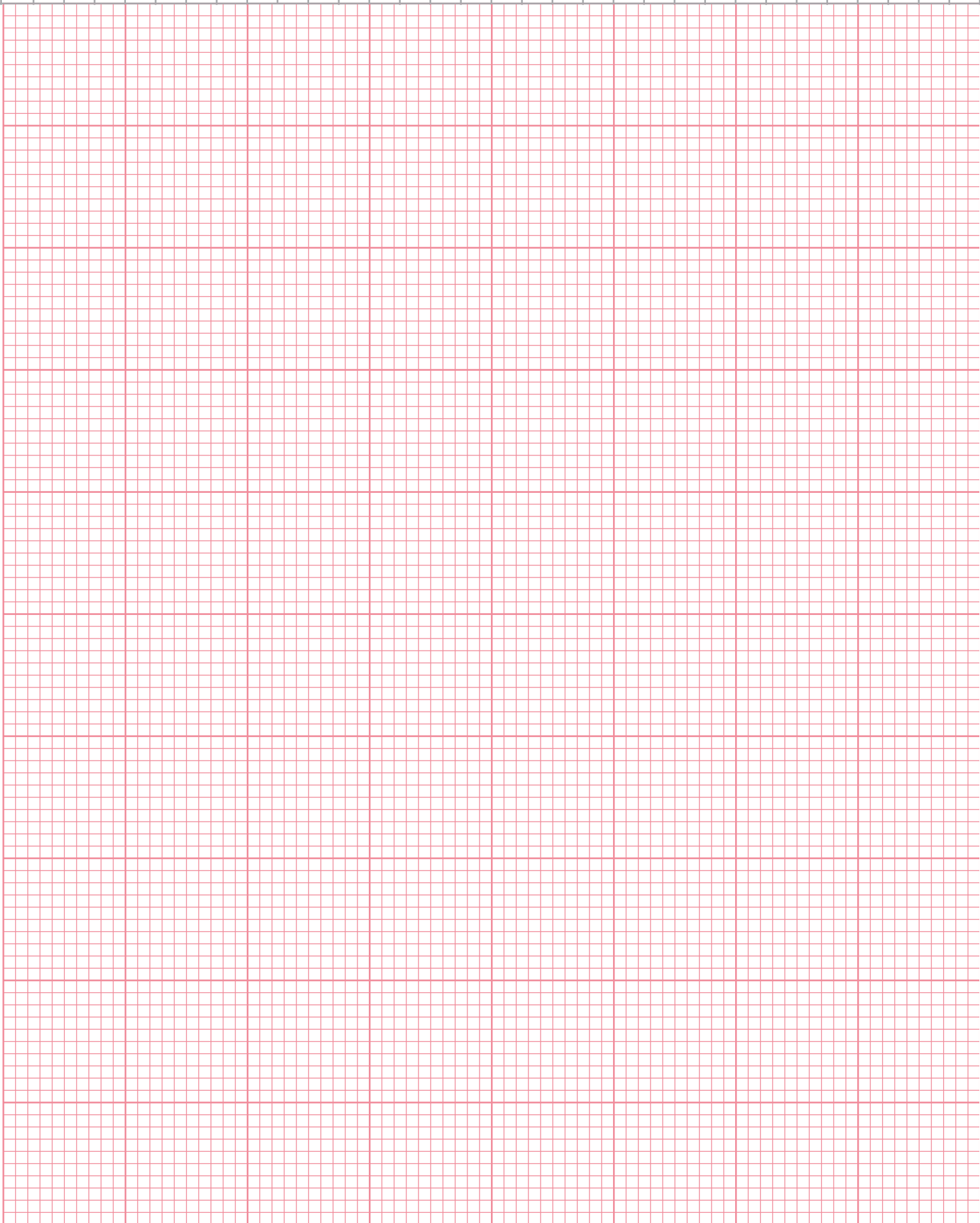



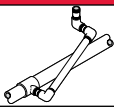
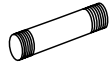

Irritrol Sprinkler System Property Layout







Your Name _____

Scale: 1" = 10' 1" = 20' 1" = 30'

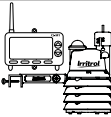
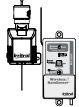

List the Parts You will Use

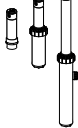
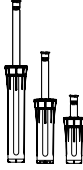
DESCRIPTION	SIZE	QTY.
 Swing Joints for connecting sprinkler heads to lines	1/2" x 6"	
 Schedule 80 Nipple	1/2" x 12"	
 Threaded Risers Schedule 40 and 80 (also for connecting anti-siphon valves to supply line)	1/2" x 1/2"	
	3/4" x 3/4" 1" x 1"	
 Standard 3/4" or 1" Gate Valve (or Ball valve)	3/4" 1"	
 Compression Tee	Slip Type 3/4" Threaded 1"	
 PVC or Poly Pipe (Check local codes for required pressure rating)	1/2"	
	3/4"	
	1"	
	1 1/4"	
 Union	3/4" 1"	
PVC PIPE FITTINGS		
 Street Elbow (For con- necting anti-siphon valves to sprinkler pipeline)	3/4" male threaded x 3/4" female socket	
 Socket Coupling (for coupling two pieces of PVC pipe)	3/4" to 3/4" 1" to 1" 1 1/4" to 1 1/4"	
 Reducer Bushing (for reducing outlet size of fitting)	1" to 3/4" 3/4" to 1/2"	
 Slip Tee (to couple same size PVC pipe at 90°)	3/4" x 3/4" x 3/4" 1" x 1" x 1"	
	1 1/4" x 1 1/4" x 1 1/4"	
 Reducer Tee (Socket x Socket x Thread) For attaching a threaded riser between sprinkler and PVC pipe	3/4"S x 3/4"S x 1/2"T	
	1"S x 1"S x 1/2"T	
	1 1/4"S x 1 1/4"S x 1/2"T	
	3/4"S x 3/4"S x 3/4"T 1"S x 1"S x 3/4"T 1 1/4"S x 1 1/4"S x 3/4"T	
 Slip Elbow To form 90° angle with same size PVC pipe	3/4" to 3/4" 1" to 1" 1 1/4" to 1 1/4"	
	3/4"S to 3/4"T	
	3/4"S to 1/2"T 1"S to 1/2"T	
 Male Threaded Adapter For adapting a threaded outlet to a socket joint for a PVC pipe	1 1/2"T to 1 1/2"S	
	1"T to 1"S	
	3/4"T to 3/4"S	
	1" T to 1/2"S 3/4"T to 1/2"S	

DESCRIPTION	MODEL NO.	QTY.
 Rain Dial® Electronic Controller	RD600-EXT-R	6 Outdoor
	RD600-INT-R	6 Indoor
	RD900-EXT-R	9 Outdoor
	RD900-INT-R	9 Indoor
	RD1200-EXT-R	12 Outdoor
RD1200-EXT-R	12 Outdoor	
 Kwik Dial® Electronic Controller	KD4-INT/EXT	4 Zone
	KD6-INT/EXT	6 Zone
	KD9-INT/EXT	9 Zone
	KD12-INT/EXT	12 Zone
 Climate Logic Weather Sensor System	CL-100-Wireless Set	
	CL-W1 Receiver CL-M1 Module	
 RainSensor RS1000	RS1000	Wireless Rain/freeze
 Valve - standard Valve - w/ flow control	2400T	1"
	2400TF	1"
 Multi-Strand Conductor Wire 2 thru 8		
 Gear-Driven Rotor	550R	
 Pop-Up Sprays	3"	I PRO300
	4"	I PRO400
	4" less body	I PRO400R
	6"	I PRO600
	6" less body	I PRO600R
	12"	I PRO1200
12" less body	I PRO1200R	
 Spray Nozzles (Variable arc, adjustable from 30° -360°) Radius	8"	PRO-VAN8
	10"	PRO-VAN10
	12"	PRO-VAN12
	15"	PRO-VAN15
	17"	PRO-VAN17
 Bubbler	533	

Assembling Pipe

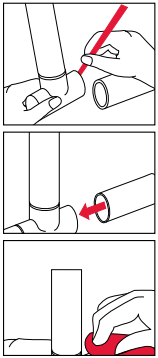

You will begin the actual installation of your sprinkler system by running pipe to match the layout you sketched earlier. A few helpful hints will make positioning and joining pipe as easy as possible.

Tips For PVC Pipe

Cut pipe with a PVC pipe cutter. Use primer to clean area that will be cemented. Brush glue freely around the outside end of the pipe and to inside of the fitting. Slip the pipe into the fitting, then twist it a quarter turn to evenly distribute the solvent for a leakproof bond. Hold for about 15 seconds until pipe is set, then wipe excess glue from around the joint.

Tips For Poly Pipe

Poly pipe should only be used between valves and sprinkler heads since it can't withstand the surge pressure between your service lines and valves. Cut poly pipe with a knife or PVC pipe cutters. Slip a stainless steel hose clamp over the pipe and insert the barrel fitting. Then position the clamp over the area of pipe surrounding the barbed part of the fitting, and tighten carefully.

Make sure all clamps are tightened snugly on poly pipe.

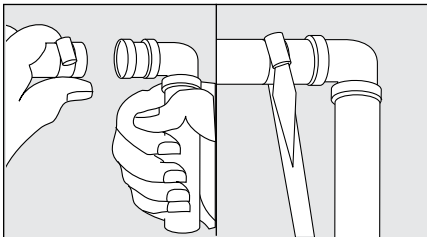

Tap Into Your Service Line

Turn off your main water supply at the water meter. Cut into the service line as near as possible to where you will position your control valves, and remove about 3" of the service line pipe. Insert a compression tee as shown, then tighten the nuts to seal against leaking.

Installing a Shut-Off Valve

Finally, install a shut-off gate or ball valve so you can turn off your entire sprinkler system if necessary. Run a pipe from the compression tee to the shut-off valve, then lay another length of pipe from the shut-off valve to the location of your control valves.

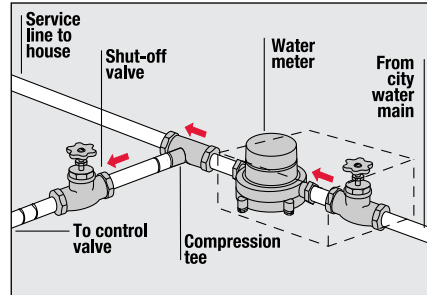

A shut-off valve lets you turn off water to your sprinkler system without affecting your household water supply.

If the Meter Is In The Basement

Shut off your water supply at the meter and insert a compression tee as described previously. Drill a 1" hole through the sill above the foundation, or drill or chisel a hole through the basement wall. (Be sure to wear eye protection.) Install the pipe as shown below, including the shut-off valve and drain cap. In freezing areas, pipe should slope downward from the control valves to the basement entrance, and a drain cap should be installed in a low position. Seal the hole in your wall with caulking compound. Drain water from your system by closing the shut-off valve and removing the drain cap, using a bucket to catch the flow.

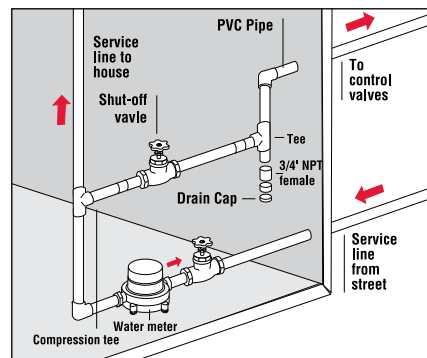

In Freezing Areas

If freezing temperatures occur in your area, install automatic drain valves at the low points in the pipe run from each control valve, and between the control

valve manifold and the shut-off valve. Use a reducer tee, and slope the automatic drain valve downward at a 45° angle into a bed of gravel to provide drainage. When your sprinkler system shuts off, the automatic drain valve opens to release any water standing in the pipes.

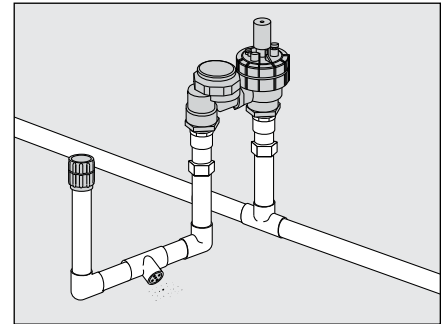

Laying Out Your system

Use wooden stakes or sprinkler marking flags to mark the location of each sprinkler head and control valve. Check the layout you sketched to make sure you have positioned everything accurately before you begin cutting pipe.

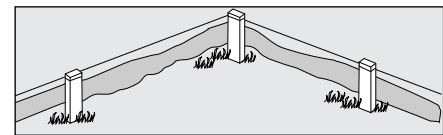

Digging Trenches By Hand

Before digging, make sure to check with your local underground locator service to be certain that there are no buried lines where you will be digging. To soften your soil, water the ground about two days before you plan to trench your yard. Use a straight-edge spade to dig "V" shaped 6" deep trenches (up to 10" in freezing climates). The depth of your trenches depends on the size of

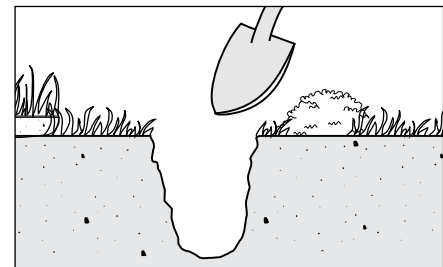

the heads you are installing as well as on the number of pipes in each trench. Place sod on one side of the trench and dirt on the other, so you can put everything back the way it was.

Using a trencher

Renting an automatic trencher can make your job easier. Check your local lawn-supply store or equipment-rental company. The renter can show you how to safely operate the machine. Do not use it to dig trenches through flower beds or ground cover, or operate it near buildings or on steep slopes.

Going Under Obstacles

Attach your hose to a length of pipe with a hose-pipe adapter. Place the end of the pipe where you want it to tunnel, for example under a concrete sidewalk, then turn on the water. Push the pipe under the obstacle as the water pressure cuts a channel. Be careful to avoid damaging walls and driveways by washing away too much soil.

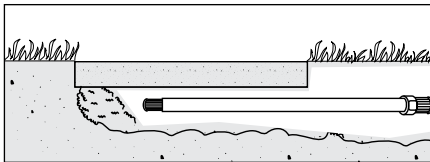

Connecting Valves

Lay the Main Line

If you have not already done so, cut a length of pipe to run from the shut-off valve to the location of your first set of control valves. If you're planning a second set of control valves in another direction, link them to the first set with another length of pipe.

Place Your Control Valves

Lay out the valves, swing-joints or risers (vertical pipe segments) and tees on the ground the way that they will fit together as a manifold.

Set Up Valve Manifold

Apply primer and glue to each joint and fit together as shown in the illustration above. Follow the manufacturer's suggested drying time (typically about 1 hour), then turn off all control valves according to the instructions packaged with them. Now turn on the water at your water meter.

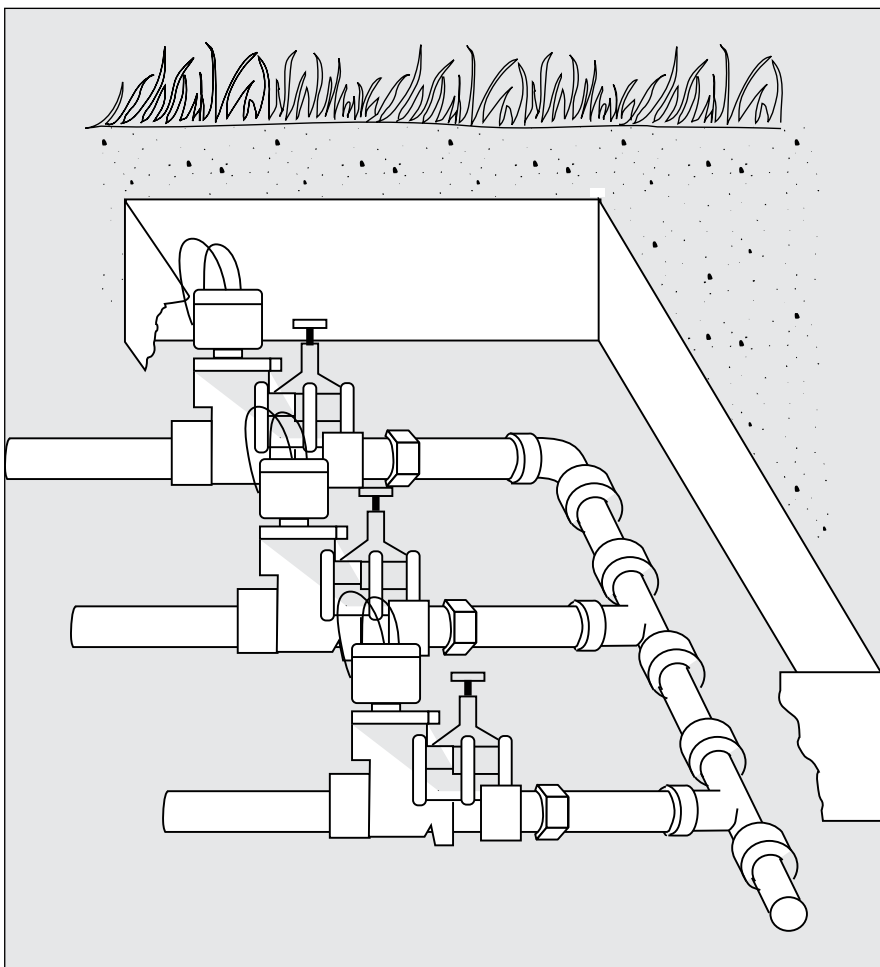

Making an In-Line Manifold

If your water supply or local codes require the use of in-line valves, several steps can enhance the durability of your installation. Bury the manifold in the ground above a bed of gravel for better drainage. And for easy access install them in a valve box available from your local retailer. Be sure to install a separate backflow device if running your system off your household water supply.

Never install the backflow device inside your house or basement.

One final note: if you are using anti-siphon valves, make sure that no other valve (manual or electric) is installed between them and your sprinkler heads. This would prevent the built-in backflow prevention from working.

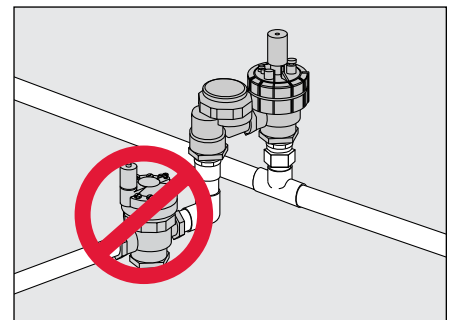

Attaching Sprinkler Heads

Place the Heads

Now match the various kinds of sprinkler heads you have purchased with the locations you have staked out according to your sketch.

Trenches from the appropriate control valve should be deep enough so that each head will be at the proper height.

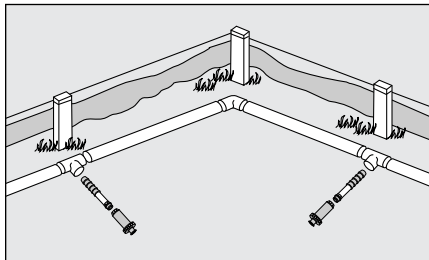

Cut The Risers / Assemble Swing-joints

Match each head to a swing joint or riser, and check that sprinklers reach the right height when pipe is in the trench. (See “Install the Sprinklers” below). Cut risers if necessary.

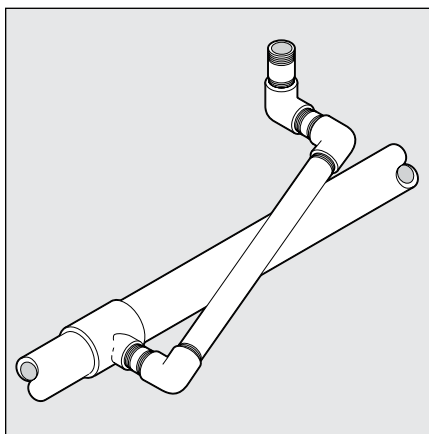

Insert The Swing-joint Assemblies

Put a tee in the pipe at each sprinkler head location; using a right-angle elbow for the head at the end of each pipe. Screw the swing-joint assembly or risers into the tee or elbow at each sprinkler head location, but don't install sprinklers yet

Flush the System

Use pipe plugs to seal all risers except the one at the end of each pipe. Turn on the water at the shut-off valve, and open the control valves one at a time using manual bleed screws until water runs clear of all debris. Check the entire system for leaks. Then close the control valves, and remove all pipe plugs.

Install the Sprinklers

Different kinds of heads are installed in different ways. The following tips will help ensure durability and proper water distribution. For accurate watering patterns, make sure all sprinklers are vertical.

Pop-Ups and Rotors

The tops of pop-up sprinkler heads and rotors should be slightly above the soil surface. Any higher, and they are subject to damage when mowing or engaging in yard activities.

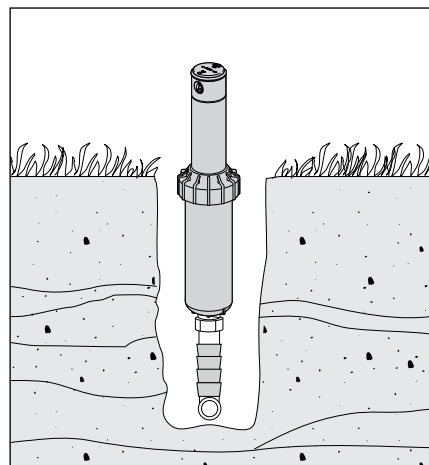

Shrub Heads and Bubblers

Shrub heads and bubblers should be mounted on risers that lift them several inches above the soil surface. This allows their patterns to reach the maximum radius.

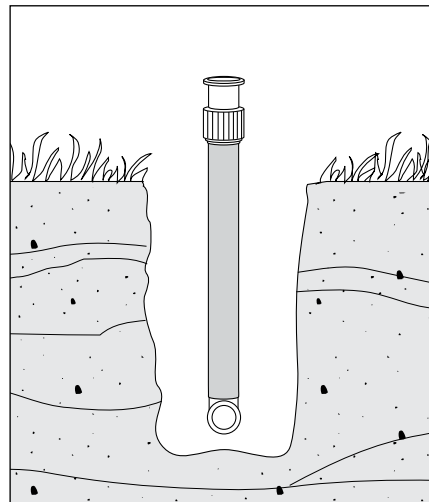

Fine Tune Your Pattern

Adjust pop-up sprinkler heads so their patterns water precisely the areas you want. Adjust Irritrol pop-up spray heads by pulling up the pop-up stem and turning it to the precise direction desired. The pop-up stem “ratchets” to allow easy, reliable adjustment of the spray direction.

Installing Your Controller

Mount The Controller

Choose an indoor location near a standard 120-volt electrical outlet. Following the instructions in the controller installation manual, fasten the unit to the wall using the screws provided, and attach the transformer. If an outdoor location is desired, use an outdoor model to protect the controller against the effects of weather.

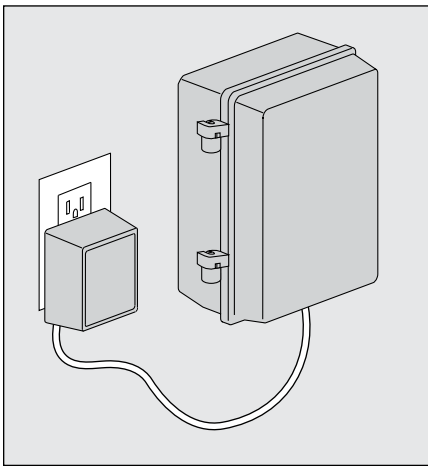

Wire the Control Valves

Run valve wiring underground wherever possible. Your dealer can provide this wire in 5 and 7 wire color-coded strands. Connect a single common (white) wire to one of the wires from each valve. Join all splices with wire nuts, then seal with waterproof connectors.

Connect the Valves to Your Controller

Connect the wire from valve number 1 to the terminal screw marked "1" on the controller, the wire from valve number 2 to the terminal "2", and so on. This allows your controller to selectively water the zone controlled by each valve. Connect the white common wire to the terminal marked "C" or "COM".

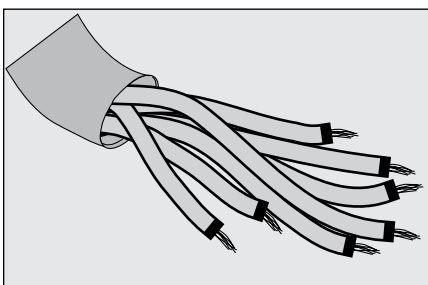

PROGRAM YOUR CONTROLLER

Now consult the owner's manual that came with your Irritrol controller. Different controllers use different programming techniques. But no matter which controller you choose, it helps to write down your zones and their watering days in the form of a schedule before you start.

Check System Operation

Now you are ready to test your installation. Open the shut-off valve all the way and test each zone using your controller's "manual" feature. Adjust the radius and pattern direction of pop-ups to avoid wasting water on walks, driveways and other areas. Also adjust shrub heads and bubblers. See Troubleshooting section on page 11 if one or more valves fails to operate. When system is functioning properly, replace soil and sod in trenches.

Additional Tips

Special Consideration for Other Uses

In addition to the standard installations previously described, Irritrol automatic sprinkler systems are also suited to certain special situations. Here's how to handle them, as well as getting the best performance after your system is installed.

WINTERIZING YOUR SYSTEM

In areas where the ground freezes, the system should be drained of all water.

1. Close the system's water supply valve
2. a) If your system has manual drain valves, open those valves to allow lines to drain.
b) If your system has automatic drain valves, the lines will drain automatically.
3. Open manual drain valve upstream of your valve manifold to allow drainage of the automatic sprinkler valves and backflow device.
4. Disassemble each automatic control valve to allow any remaining water to drain. Reassemble the valves.
5. Follow recommended winterizing instructions for your specific sprinkler controller.

To winterize with compressed air, we recommend hiring a professional.

Connecting a Pump Start Relay For a Well, Tank or Pond

A pump start relay lets you automatically activate a pump if your water supply requires one. We recommend the Irritrol Pump Start Relay, Model number SR-1. The controller must be at least 12 feet from the pump to prevent malfunctions. See pump start relay manual for installation instructions.

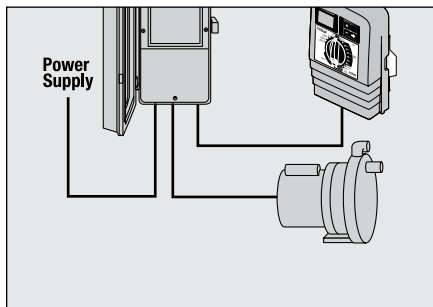

Automating Your Drip Irrigation System

Irritrol also makes it easy to add the convenience of automatic operation to your drip system. You can automate your system in one of two ways. Run a length of PVC pipe from an existing valve to a location near your drip installation. Or, attach drip tubing with a PVC-to-Tubing Connector. Your drip system will now operate on the schedule set for that Zone.

You may also attach drip tubing to a riser using a sprinkler riser adapter.

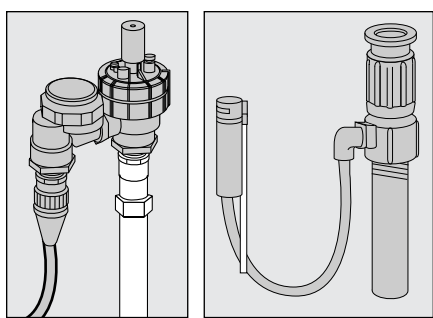

Maintenance

Clean your system periodically by removing sprinkler heads, inspecting for debris, and flushing pipes and risers. In freezing areas, drain all water from the system, blow water from control valves, and close your shut-off valve before the first freeze. Wait until the spring thaw before operating the system again.

Operating Your System

If possible, schedule watering cycles in the early morning, when water pressure is at its highest. This allows ample time for water to soak in while evaporation and wind drift are low. Evening watering can leave foliage damp for too long, leading to mildew under some circumstances.

Watering Tips

In hot weather, plan on supplying about 13mm (1/2") water every other day to a typical lawn. Clay soils do better with 6-8mm (1/4") every day to reduce runoff and puddling. Ask your local nursery for a schedule suited to the special weather and soil conditions in your area. Once you know your water needs, place a flat pan or other container on you lawn and measure how long it takes your sprinkler system to deliver that precise amount. Use these run times to prevent over watering.

Troubleshooting

Malfunctions are not common, but when they occur, they are often due to one of these frequently overlooked causes.

See the controller manual for additional information.

For more information

The Irritrol customer service team is always ready to offer you assistance on sprinkler-system design and installation questions. Call your local Irritrol dealer or call our toll-free hotline (PST).



Problem	Possible Cause
One or more valves do not water	<ol style="list-style-type: none"> 1. Faulty solenoid 2. Poor wire connection 3. Possible break in wire 4. Valve flow stem screwed down too far 5. The common wire is not connected 6. Shut-off or service valve is closed
Circuit breaker is tripped	<ol style="list-style-type: none"> 1. Faulty solenoid 2. Poor or shorted wire connection
A zone will not shut off electrically	<ol style="list-style-type: none"> 1. Faulty valve 2. Dirt or debris are stuck in valve
Spray does not spray evenly	<ol style="list-style-type: none"> 1. Screen or filter basket is clogged
Spray will not retract into the ground	<ol style="list-style-type: none"> 1. Dirt is lodged in wiper seal 2. Wiper seal is worn
Spray covers incomplete pattern	<ol style="list-style-type: none"> 1. Nozzle is clogged with dirt



Your home's landscaping represents a considerable investment in both time and money. That is why you want to protect your investment with the dependability and performance of Irritrol® irrigation products. For years, Irritrol has been a top choice of both homeowners and yard care professionals. Irritrol offers the most complete line of automatic controllers, valves, sprinkler heads, and bubblers that help conserve water and reliably satisfy your home watering needs. Watering your yard with an Irritrol irrigation system makes it easy — so you can spend more time enjoying your home's landscaping and less time watering. For more information, call 1-800-231-5117 or visit our web site at www.irritrol.com

We reserve the right to improve our products and make changes in the specifications and designs without notice and without incurring obligation. Products depicted in this brochure are for demonstration purposes only. Actual products offered for sale may vary in design and features.