

Models/Modelos/Modèles  
**9690-DST & 9690T-DST**  
 Series/Series/Seria  
**BRODERICK™**

**RP100845▲**

Escutcheon, Mounting Screws (2), Gasket, Nuts (2) & Washers (2) (not included)  
 Chapa, tornillos de montaje (2), empaque, tuercas (2) y arandelas (2) (no se incluyen)  
 Plaque de finition, vis de montage (2), joint, écrous (2) et rondelles (2) (non inclus)

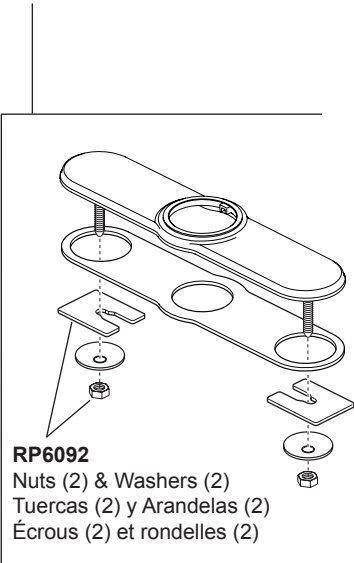

**RP6092**

Nuts (2) & Washers (2)  
 Tuercas (2) y Arandelas (2)  
 Écrous (2) et rondelles (2)

**RP80523**

Steel Weight Assembly  
 Ensemble de la Pesa de Acero  
 Masselotte en acier



**RP100833▲**

Sprayer Assembly  
 Ensemble de Rociador  
 Pulvérisateur



**RP100832**

Gasket  
 Empaque  
 Joint

**RP92605**

Indicator Base Assembly  
 Ensemble de la base con indicador  
 Base à voyant indicateur

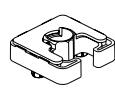

**RP60911**

Clip  
 Presilla  
 Agrafe

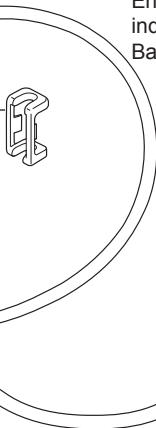

**RP73984**

O-Ring & Clip  
 Anillo y Presilla  
 Joint torique et Agrafe

**RP80522**

Hose Assembly  
 Ensemble de la manguera  
 Tuyau souple

**RP60923**

Retainer  
 Funda  
 Douille

**RP100837▲**

Spout  
 Canalón  
 Bec

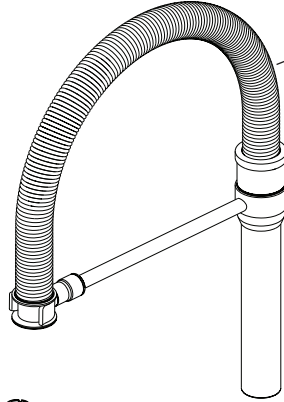

**RP91902**

Cartridge Assembly  
 Ensemble del la Válvula  
 Soupape

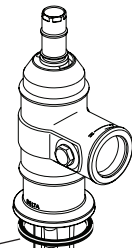

**RP100836▲**

Cap & O-Ring  
 Bonete y Anillo O  
 Chapeau et Joint toriques

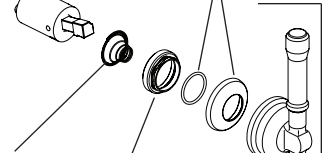

**RP78741**

Contact  
 Spring  
 Resorte de  
 Contacto  
 Ressort de  
 contact

**RP74776**

Bonnet Nut  
 Tuerca  
 Écrou

**RP100835▲**

Set Screw & Button  
 Tornillo de Ajuste y botón  
 Vis de calage et bouton

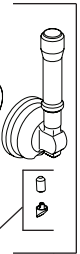

**RP13938**

O-Rings (2)  
 Anillos "O" (2)  
 Joints torique (2)

**RP100834▲**

Handle, Set Screw & Button  
 Manija, tornillo de presión y Botón  
 Poignée, vis de calage et bouton

**RP92714**

Mounting Bracket Assembly, Spacer, Nut & Wrench  
 Ensemble del soporte de montaje, Espaciador, la tuerca y la llave de tuercas  
 Fixation de montage, spacer, écrou et clé

**RP51243**

Inlet Gaskets  
 Empaques para el tubo de entrada  
 Joints côté alimentation

Models/Modelos/Modèles  
**9690-DST & 9690T-DST**  
 Series/Series/Seria  
**BRODERICK™**

**EP92546**  
 Solenoid Assembly  
 Ensamble de Solenoide  
 Électrovanne

For PC, SS, AR & KS finishes, order **EP92546**  
 For PL, MW, RB & SP finishes, order **EP92546**

Para acabados PC, SS, AR y KS, ordene **EP92546**  
 Para acabados PL, MW, RB y SP, ordene **EP92546**

Pour les finis PC, SS, AR et KS, commandez **EP92546**  
 Pour les finis PL, MW, RB et SP, commandez **EP92546**

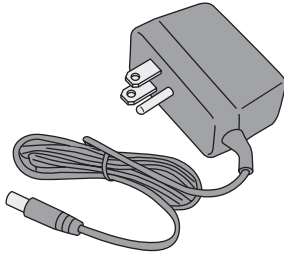

**EP73954**  
 9 Volt Power Supply  
 (Accessory Order Only)  
 Fuente de alimentación de 9  
 voltios  
 (Orden de accesorios  
 solamente)  
 Alimentation électrique 9 volts  
 (L'accessoire seulement)

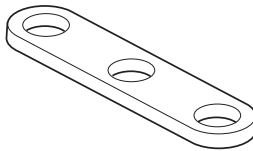

**RP37490**  
 Thin Deck Aid (Not Included)  
 Soporte para encimera  
 delgada  
 (No incluido)  
 Plaque de renfort (non incluse)

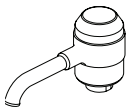

**RP83779**  
 Pump  
 Bomba  
 Pompe



**RP100632**  
 Dispenser Assembly  
 (Not included)  
 Ensamble del  
 Dispensador (no se  
 incluyen)  
 Distributeur (non inclus)

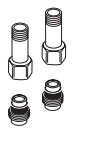
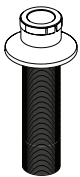

**RP53468**  
 Check Valves  
 Válvulas  
 Checadoras  
 Clapets de non-  
 retour



**RP78489**  
 Nut  
 Tuerca  
 Ecrou



**RP78490**  
 Bottle  
 Bottella  
 Bouteille

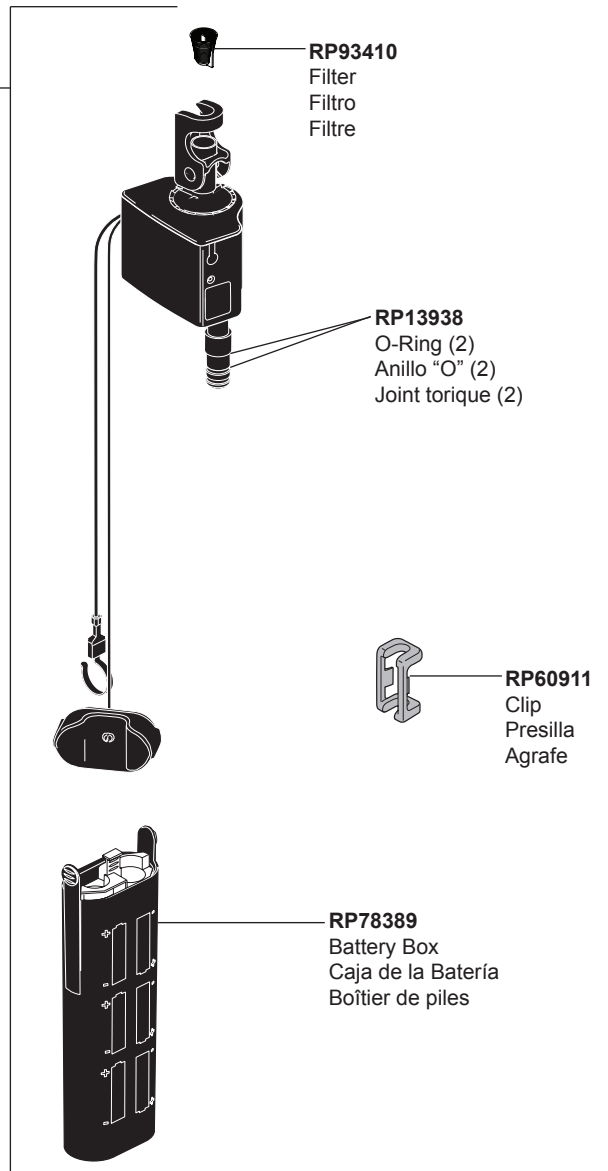

**RP93410**  
 Filter  
 Filtro  
 Filtre

**RP13938**  
 O-Ring (2)  
 Anillo "O" (2)  
 Joint torique (2)



**RP60911**  
 Clip  
 Presilla  
 Agrafe

**RP78389**  
 Battery Box  
 Caja de la Batería  
 Boîtier de piles

Other useful accessories that may be purchased separately.  
 Otros accesorios útiles que se pueden comprar por separado.  
 Autres accessoires utiles pouvant être achetés séparément.

**RP63263**  
 Adapters  
 3/8"-24 UNEF to 1/2"-20 UN &  
 3/8"-24 UNEF to 1/2"-14 NPSM  
 Adaptadors  
 3/8"-24 UNEF a 1/2"-20 UN &  
 3/8"-24 UNEF a 1/2"-14 NPSM  
 Adapteurs  
 3/8 po-24 UNEF à 1/2 po-20 UN et  
 3/8 po-24 UNEF à 1/2 po-14 NPSM

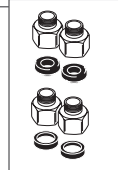

**RP63264**  
 Adapters (10) 3/8"-24 UNEF to 1/2"-20 UN  
 Adaptadors (10) 3/8"-24 UNEF a 1/2"-20 UN  
 Adapteurs (10) 3/8 po-24 UNEF à 1/2 po-20 UN



**RP63265**  
 Adapters (10) 3/8"-24 UNEF to 1/2"-14 NPSM  
 Adaptadors (10) 3/8"-24 UNEF a 1/2"-14 NPSM  
 Adapteurs (10) 3/8 po-24 UNEF à 1/2 po-14 NPSM

