

BRIZO®

IMPORTANT DOCUMENTS ENCLOSED

CAUTION:

To reduce the risk of injury due to hot water burns, make sure the enclosed labels are applied where specified on the label.

DOCUMENTOS IMPORTANTES INCLUIDOS

AVISO:

Para reducir el riesgo de lesión por quemaduras de agua caliente, asegúrese que las etiquetas incluidas se han aplicado donde se ha especificado en la etiqueta.

DOCUMENTS IMPORTANTS À L'INTÉRIEUR

MISE EN GARDE :

Pour réduire le risque d'ébouillantage, veuillez apposer les étiquettes fournies aux endroits indiqués sur celles-ci.

NOTICE TO INSTALLER: Place this label on the water heater next to the temperature adjustment knob.

WARNING:

This series of tub/shower valves does not adjust automatically for changes in temperature at the hot water heater or inlet. If the temperature setting of the hot water heater or inlet is changed, the setting on these valves must be adjusted manually! Failure to re-adjust the valve may result in hot water burns or extreme cold resulting from variations in line pressure (such as when a dishwasher or washing machine is in use while you are taking a shower). After installation, verify that the temperature knob on the valve is set so that changes in line pressure or temperature do not result in uncomfortable water temperature changes. **If the temperature setting of the hot water heater or inlet is changed after installation of the valve, the setting of the temperature knob also must be changed!** Consult the installation instruction sheet for instructions on how to make this setting, or call us at 1-877-345-BRIZO.

AVISO AL INSTALADOR: Coloque esta etiqueta en el calentador de agua al lado de la perilla que ajusta la temperatura.

AVISO:

Esta serie de válvulas para bañeras/regaderas no se ajusta automáticamente a los cambios de temperatura en el calentador de agua o del agua de entrada. ¡Si el ajuste de temperatura del calentado del agua caliente o del agua de entrada, el ajuste en estas válvulas debe ajustarse manualmente! El no reajustar la válvula puede resultar en quemaduras por agua caliente o temperaturas de agua extremadamente frías resultando en variaciones de presión y temperatura (como cuando el fregador de platos o la lavadora están funcionando mientras que se baña). Después de la instalación, verifique que la perilla para el control de la temperatura en la válvula está ajustada para que cambios de presión y de temperatura en la línea no resulten en cambios de temperatura del agua incómodos. **Si el ajuste de la temperatura del calentador de agua o de la entrada de agua se cambia después de la instalación de la válvula, la perilla que ajuste la temperatura también se debe cambiar!** Consulte con su hoja de instrucciones de instalación para saber como se ajusta o cambia el ajuste o llámenos al 1-877-345-BRIZO.

AVIS À L'INSTALLATEUR : Placez cette étiquette sur le chauffe-eau, près du bouton de réglage de température.

AVERTISSEMENT:

La soupape de robinet de baignoire ou de douche de cette série ne se règle pas automatiquement en fonction des changements de température de l'eau chaude au chauffe-eau ou de l'eau d'alimentation. En cas de modification du réglage de température du chauffe-eau ou de la température de l'eau d'alimentation, le réglage de ces soupapes doit être modifié manuellement! Si le réglage de la soupape n'est pas modifié, le robinet pourra permettre l'écoulement d'eau très chaude susceptible de causer l'ébouillantage ou d'eau très froide, sous l'effet des variations de pression et de température dans la tuyauterie d'alimentation (lorsque la douche est utilisée en même temps que le lave-vaisselle ou la machine à laver, par exemple). Après l'installation, assurez-vous que le bouton de température sur la soupape est réglé de manière que les fluctuations de pression et de température dans la tuyauterie d'alimentation n'entraînent pas de changements de température de l'eau inconfortables. **En cas de modification du réglage de température du chauffe-eau ou de la température de l'eau d'alimentation après l'installation de la soupape, le réglage du bouton de température doit être modifié!** Pour régler le bouton de température, consultez la feuille d'instructions d'installation ou appelez-nous au 1-877-345-BRIZO.

NOTICE TO INSTALLER: Place this label close to the valve where the owner will see it, such as inside the door of a cabinet or vanity.

WARNING:

Water temperature changes due to seasonal or other inlet variations, such as changing the setting on the hot water heater may require adjustment of the temperature knob on your tub/shower valve to ensure a safe maximum temperature. This valve series does not automatically adjust for inlet temperature changes. If changes occur and you are not sure how to make the necessary temperature knob adjustments, please consult the installation instruction sheet provided with this valve or call 1-877-345-BRIZO. This valve is designed to reduce the risk of injury due to inlet pressure or temperature changes, commonly caused by dishwashers, washing machines, toilets and the like. **It may not provide protection from hot water burns when there is a failure of other temperature controlling devices elsewhere in the plumbing system.** After making the necessary adjustments please fill in the information below. This valve/system has been set by the person listed below to help ensure a safe maximum temperature. Any change in the setting may raise the temperature of the water coming out of the shower or bath above the limit considered safe and could lead to hot water burns. If this label has not been completed, you should verify that the temperature knob has been properly adjusted to suit your individual installation. The installation instruction sheet supplied with the valve provides information on how to make this setting.

AVISO AL INSTALADOR: Coloque esta etiqueta cerca de la válvula donde el propietario la pueda ver, tal como dentro de la puerta del gabinete o el tocador.

AVISO:

Los cambios de temperatura del agua por variaciones estacionales u otras variaciones en el agua de entrada, como cambiando el ajuste en el calentador de agua pueden requerir el ajuste de la perilla para el control de la temperatura de su unidad bañera/regadera para ayudar a asegurar una temperatura máxima segura. Este válvulas no se ajusta automáticamente a cambios de temperatura en el agua de admisión. Si los cambios ocurren y usted no está seguro como hacer los ajustes necesarios con la perilla para controlar la temperatura, por favor consulte la hoja de instrucciones de instalación proporcionada con esta válvula o llámenos al 1-877-345-BRIZO. Esta válvula está diseñada para reducir el riesgo de lesión por cambios de temperatura del agua que entra o por los cambios de presión del agua que comúnmente son causados por los usos simultáneos de fregadoras de platos, lavadoras, sanitarios y aparatos similares. **Pueda no proporcionar protección de quemaduras por el agua caliente cuando hay una falla de otros mecanismos que controlan la temperatura del agua en otro sitio del sistema de plomería.** Después de hacer los ajustes necesarios, por favor escriba la información a continuación. Esta válvula/sistema ha sido ajustada por la persona indicada a continuación para ayudar a asegurar una temperatura máxima segura. Cualquier cambio al ajuste puede aumentar la temperatura del agua que sale de la ducha o el baño sobre el límite considerado seguro y puede resultar en quemaduras por el agua caliente. Si esta etiqueta no se a llenado, debe verificar si la perilla para el control de la temperatura hay sido correctamente ajustada para al gusto de su instalación individual. La hoja de instrucciones de instalación proporcionada con las válvulas le suministra información sobre como hacer esto.

AVIS À L'INSTALLATEUR : Placez cette étiquette près de la soupape à un endroit où le propriétaire pourra la voir, du côté intérieur de la porte de l'armoire ou du meuble par exemple.

AVERTISSEMENT:

La température de l'eau peut varier en raison des changements de saison, d'une modification du réglage du chauffe-eau ou d'autres changements. Par conséquent, un réglage du bouton de température de votre soupape de douche ou de baignoire peut s'imposer pour que la température maximale de l'eau demeure sécuritaire. Les soupapes de cette série ne s'ajustent pas automatiquement aux changements de température de l'eau d'alimentation. Si des changements vous obligent à régler le bouton de température et vous n'êtes pas certain de la marche à suivre, veuillez consulter le feuillet d'instructions fourni avec la soupape ou appeler au 1-877-345-BRIZO. Cette soupape est conçue pour réduire les risques de blessures causées par des changements de la température ou de la pression de l'eau d'alimentation habituellement causés par le lave-vaisselle, la machine à laver, une toilette ou un autre appareil qui consomme de l'eau. **Elle peut ne pas assurer de protection contre l'ébouillantage en cas de défectuosité d'un autre dispositif de régulation de la température dans la tuyauterie. Après avoir effectué le réglage nécessaire, veuillez inscrire l'information requise ci-dessous.** La personne dont le nom figure ci-dessous a réglé cette soupape pour qu'elle puisse maintenir une température maximale sécuritaire. Toute modification du réglage peut entraîner une élévation de la température de l'eau s'écoulant par la douche ou dans la baignoire au delà de la limite considérée sécuritaire, ce qui pourrait causer un ébouillantage. Si cette étiquette n'a pas été remplie, vous devriez vous assurer que le bouton de température a été réglé en fonction des caractéristiques de votre installation. Le feuillet d'instruction fourni avec la soupape indique la marche à suivre pour effectuer le réglage.

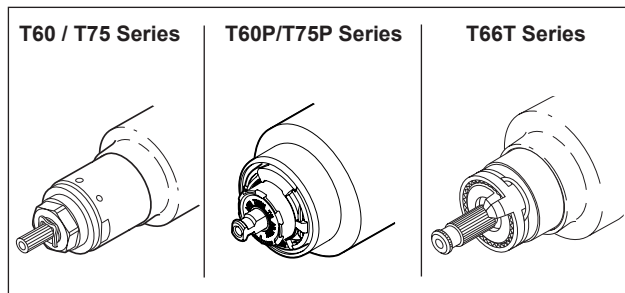

BRIZO®

TO BE FILLED OUT BY THE INSTALLER / PARA SER LLENADO POR EL INSTALADOR / A REMPLIR PAR L'INSTALLATEUR:

BY/POR/PAR _____ COMPANY/COMPANIA/COMPAGNIE _____
DATE/FECHA/LE _____ PHONE/TELÉFONO/TELÉPHONE _____

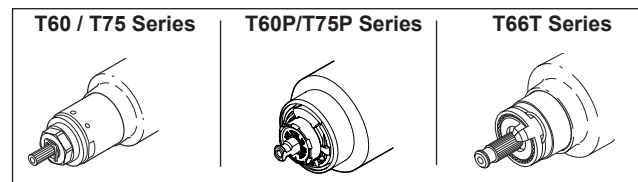

BRIZO®

T66T0 _____

Register Online
www.brizo.com/customer-support/product-registration

To reference replacement parts and access additional technical documents and product info, visit www.brizo.com



1-877-345-BRIZO (2749)
brizosupport@brizo.com

Read all instructions prior to installation.

CAUTION

Failure to read these instructions prior to installation may result in personal injury, property damage, or product failure. Manufacturer assumes no responsibility for product failure due to improper installation.

You may need:

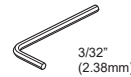
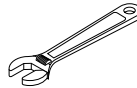
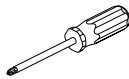

CAUTION: This system/device must be set by the installer to ensure safe, maximum temperature. Any change in the setting may raise the discharge temperature above the limit considered safe and may lead to hot water burns.

NOTICE TO INSTALLER: CAUTION!—As the installer of this valve, it is your responsibility to properly INSTALL and ADJUST this valve per the instructions given. This valve does not automatically adjust for inlet temperature changes, therefore, someone must make the necessary temperature knob adjustments at the time of installation and further adjustments may be necessary due to seasonal water temperature change. YOU MUST inform the owner/user of this requirement by following the instructions. If you or the owner/user are unsure how to properly make these adjustments, please refer to page 4 and if still uncertain, call us at 1-877-345-BRIZO (2749).

After installation and adjustment, you must affix your name, company name and the date you adjusted the temperature knob to the caution label

provided and apply or attach the label to the back side of the closest cabinet door and the warning label to the water heater. Leave this Instruction Sheet for the owner's/user's reference.

WARNING: This thermostatic bath valve is designed to minimize the effects of outlet water temperature changes due to inlet pressure and temperature changes, commonly caused by dishwashers, washing machines, toilets and the like. It may not provide protection from hot water burns when there is a failure of other temperature controlling devices elsewhere in the plumbing system, if the temperature knob is not properly set or if the hot water temperature is changed after the settings are made or if the water inlet changes due to seasonal changes.

WARNING: Do not install a shut-off device on either outlet of this valve. When this type of device shuts off the water flow, it can defeat the ability of the valve to balance the hot and cold water pressures.

1

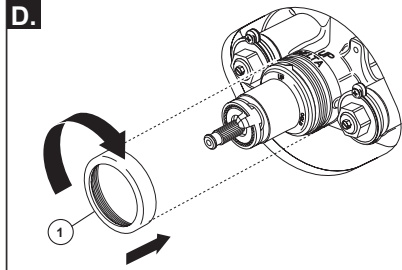
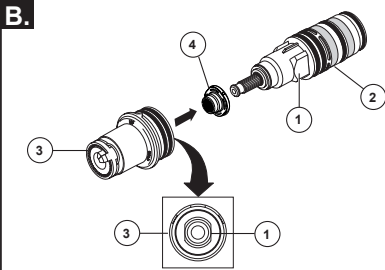
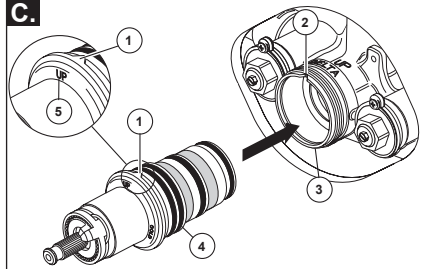
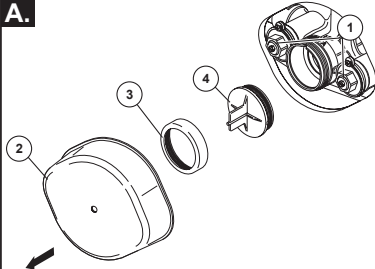

Note: The Sensori® Thermostatic Valve rough must be installed before installing the trim.

A. Turn off water supplies from main or inlet stops (1). Remove plasterguard (2), bonnet nut (3) and test cap (4) from the body.

B. Verify presence of either o-ring (on some models) or friction bushing (4) located on splined valve stem.

Locate flats (1) on cartridge (2) and inside of sleeve (3). Align flats and insert cartridge into sleeve being careful not to push on copper element at end of cartridge.

C. Locate "V" (1) on cartridge sleeve and "V" notch (2) on valve body (3). Align the "Vs" and press sleeve and cartridge assembly (4) into valve body (3) and note the "UP" position (5).

D. Slide bonnet nut (1) over the cartridge and thread onto the body. Hand tighten securely.

2

A.

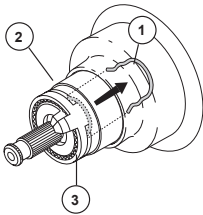

B.

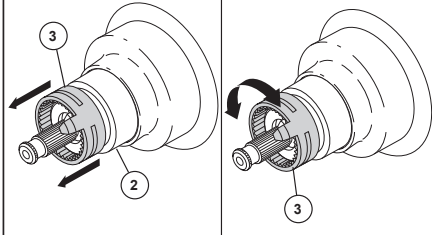

C.

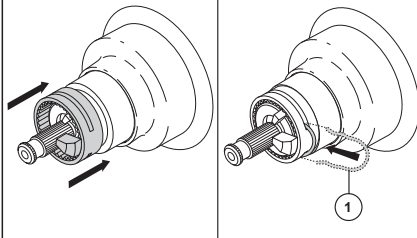

IMPORTANT:

The Rotational Limit Stop is used to limit the amount of hot water available such that, if set properly, the user will not be scalded if the handle accidentally is rotated all the way to "hot" when a person is showering. The first position allows the **LEAST** amount of hot water to mix with the cold water in the system. In the first position the water will be the coldest possible when the handle is turned all the way to hot. As you move the Rotational Limit Stop counterclockwise, you progressively add more and more hot water in the mix. The last position to the left will result in the greatest amount of hot water to the mix, and the greatest risk of scald injury if someone accidentally turns the valve handle all the way to the hot side while showering.

WARNING: In some instances, setting the Rotational Limit Stop in the hottest position (full counterclockwise) could result in scald injury. It is necessary to adjust the Rotational Limit Stop so that the water coming out of the valve will not scald the user when the handle of the valve is rotated to the hot side.

- According to the majority of industry standards, the maximum allowable temperature of the water exiting the valve is 120°F (Your local plumbing codes may require a water temperature less than 120°F).
- Run the water so that the cold water is as cold as it will get and hot water is as hot as it will get. Place the handle on the stem and rotate the handle counterclockwise until the handle stops.
- Place a thermometer in a plastic tumbler and hold

in the water stream. If the water temperature is above 120°F, the Rotational Limit Stop must be repositioned clockwise to decrease valve outlet water temperature to be less than 120°F or to meet the requirements of your local plumbing codes.

- To adjust the temperature of the water coming out of the valve:

- A.** Pull the clip (1) from the sleeve (2) and rotational limit stop (3).
 - B.** Note the position of the rotational limit stop (3). Pull the rotational limit stop out from the sleeve (2) enough so that it can be rotated clockwise to decrease the outlet temperature or counterclockwise to increase the outlet temperature.
 - C.** Once the desired outlet temperature is reached, make sure rotational limit stop is pushed back onto the sleeve so that the clip (1) can be reinstalled. **Make sure clip is secure on sleeve.** Reassemble handle to valve stem.
- **MAKE SURE COLD WATER FLOWS FROM THE VALVE FIRST. MAKE SURE WATER FLOWING FROM THE VALVE AT THE HOTTEST FLOW POSSIBLE DOES NOT EXCEED 120°F OR THE MAXIMUM ALLOWED BY YOUR LOCAL PLUMBING CODE.**

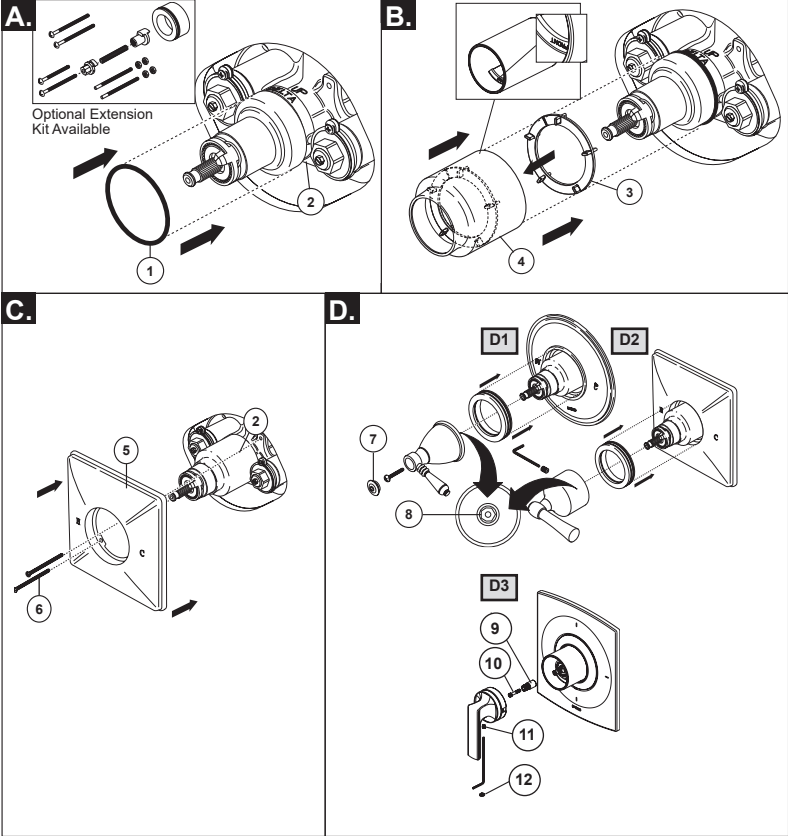
3

A. Slide O-ring (1) over cartridge and the bonnet nut (2). The O-ring, which acts as a spacer to steady the sleeve, should rest behind the bonnet nut. **Note: Depending on the location of valve within the wall and wall thickness, an optional extension kit can provide an additional 1 3/4" of wall thickness.** To reference replacement parts visit www.brizo.com.

B. If your model requires a spacer (3), install it into sleeve (4). Slide the sleeve over the cartridge, body and O-ring. Ensure sleeve is properly positioned over the front of cartridge.

C. Secure the escutcheon (5) to the rough (2) with the 2 screws provided (6). Do not overtighten escutcheon screws.

D. **D1: Handle with Axial Screw**
Remove the top button (7) from the handle (if already assembled) by pulling straight up. Select legacy models have a plastic insert (8) inside the bottom of the handle. For those models, verify plastic insert is inside the handle.

Make sure valve is in the full cold position (to the right) and align lever of lever handle models to the cold position on the escutcheon and press handle onto valve stem. Secure handle with screw provided and press button back into top of handle.

D2: Handle with Side Screw

Select legacy models have a plastic insert (8) inside the bottom of the handle. For those models, verify the plastic insert is inside the handle. Make sure valve is in the full cold position and align lever of lever handle models to the cold position on the escutcheon and press handle onto valve stem. Secure handle with set screw provided and install set screw cover (if included).

D3: Handle with Stem Extender

Install stem extender (9) onto valve stem and secure with screw (10). Slide handle onto stem extender and tighten set screw (11). Insert button (12) until properly seated

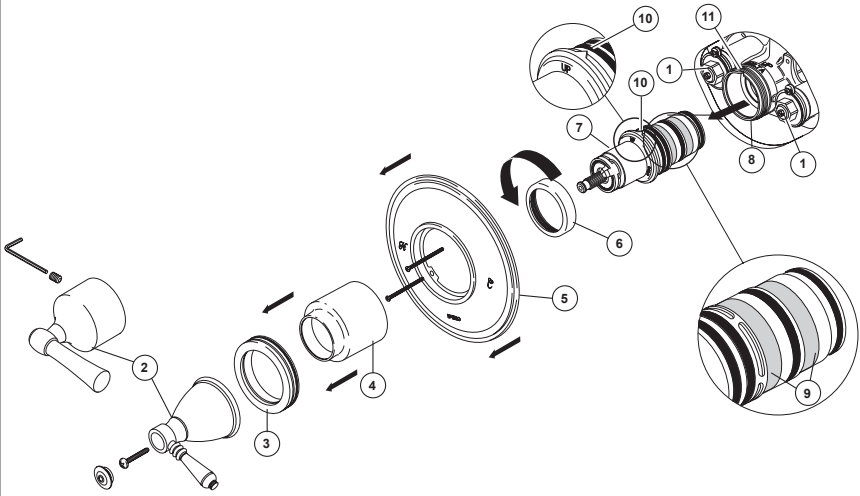

Maintenance

If you notice reduced flow or the outlet temperature fluctuating, the cartridge screens may need cleaned. To clean the cartridge screens: Shut off water from the main valve or from stops (1). Remove the handle (2), trim ring (3), trim sleeve (4), escutcheon (5) (if using stops) and unscrew bonnet nut (6). Carefully pull cartridge and sleeve assembly (7) from the valve body (8). Carefully brush or wash away any debris that may be on the screens (9). After cleaning, reinstall cartridge and sleeve assembly back into the valve body, making sure to align the "V" (10) on the sleeve with the "V" groove (11) on the valve body (Note the "UP" on the sleeve). Secure cartridge and sleeve assembly by screwing the bonnet securely onto the valve body. Turn the stops on, and reassemble remaining parts.

Cleaning and Care

Care should be given to the cleaning of this product. Although its finish is extremely durable, it can be damaged by harsh abrasives or polish. To clean, simply wipe gently with a damp cloth and blot dry with a soft towel.