



DuraTech®

**All-fuel, double-wall
chimney system.**

UL 103 HT, UL 103, and ULC S604.



Specifications

Applications

5"-8" DuraTech is a double-wall, all-fuel chimney system for use with wood stoves, fireplaces, furnaces, boilers, ranges, water heaters, or other appliances fueled by wood, oil, coal, or gas, and zero-clearance fireplaces that are factory-built.

Materials and Construction

5"-8" diameter pipe features inner wall of .020" 430 stainless steel. Outer wall options of .016" 430 stainless steel or .021" galvalume steel. A Thermal Tech (ceramic refractory) blanket insulation is encased between walls. Stainless steel end rings seal the pipe.

DuraTech features light weight insulation, twist-lock fittings, support boxes with factory installed starter sections, elbows with 360° swivel base, select black finish pipe lengths, and five foot length pipe sections.

Clearances

2" clearance to combustibles.

Shrouds

UL Listed with DuraVent shroud specifications. Information available online at www.duravent.com or call and request L157.

Diameters

5"-8"

Listings

c-UL-us Listed to UL 103 HT and ULC S604 (MH7399)
(Stainless steel outer wall required for installation in Canada).



UL 103 HT and ULC S604 System

DuraTech 5"-8"

With a Thermal Tech blanket insulation encased between dual walls, DuraTech offers the optimum in safety and performance. It keeps the outer wall of the chimney cool, while ensuring high flue gas temperatures for optimum draft performance.

The inner wall is 25% thicker than competitive chimneys for an extra margin of safety. No locking bands or mechanical fasteners required.

DuraTech's sleek 1" wall design provides for easy installations through 16" on-center framing. For tight installations, a Reduced Clearance Square Ceiling Support Box is available (6" diameter DuraTech only).

Designed for normal, continuous operation at 1000° F flue gas temperatures, DuraTech is subjected to rigorous and stringent HT requirements of the UL standard, including one hour at 1400° F, plus three ten minute chimney fire tests at 2100° F.



UL 103 System

DuraTech 10"-24"

DuraVent now offers DuraTech in large diameters to vent large-scale residential fireplaces and building heating appliances.

DuraTech chimney is tested and listed for continuous operation at 1000° F flue gas temperatures, one hour at 1400° F and ten-minutes at 1700° F, in accordance with the UL 103 test standard.



Specifications

Applications

10"-24" large diameter DuraTech is a 1" wall, all-fuel chimney system for use with wood stoves, fireplaces, furnaces, boilers, ranges, water heaters, or other appliances fueled by wood, oil, coal, or gas.

Materials and Construction

10"-24" diameter pipe feature .027" 430 stainless steel inner wall and outer wall of .029" galvalume or .027" 430 stainless steel. A Thermal Tech (ceramic refractory) blanket insulation is encased between walls. Stainless steel end rings seal the pipe.

Clearances

2" clearance to combustibles.

Shrouds

UL Listed with DuraVent shroud specifications. Information available online at www.duravent.com or call and request L157.

Diameters

10", 12", 14", 16", 18", 20", 22", and 24".

Listings

c-UL-us Listed to UL 103 and ULC S604 (MH7399)
(Stainless steel outer wall required for installation in Canada.)



Typical Installations For 5"- 24" DuraTech

updated typical installations

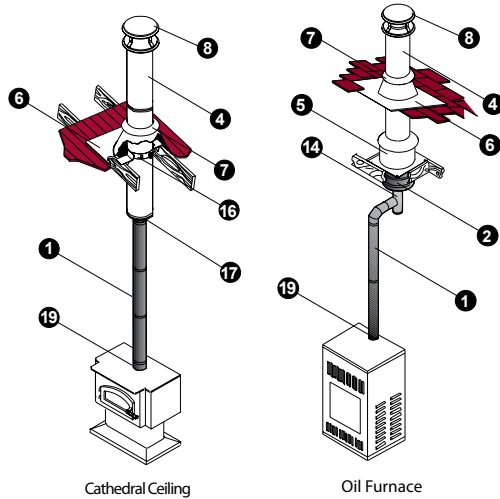

Cathedral Ceiling

Oil Furnace

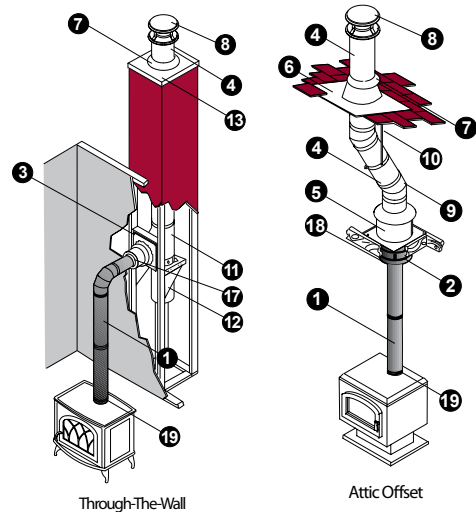

Through-The-Wall

Attic Offset

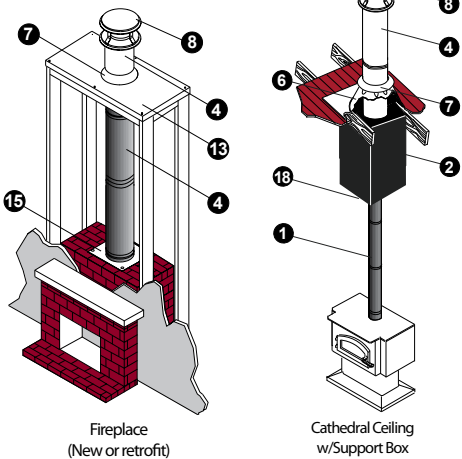

Fireplace
(New or retrofit)

Cathedral Ceiling
w/Support Box

Installation Key			
1	DVL or DuraBlack	11	Tee with Tee Cap
2	Ceiling Support	12	Tee Support
3	Wall Thimble	13	Chase Top Flashing
4	Chimney Pipe	14	Base Tee/Double Tee
5	Attic Insulation Shield	15	Anchor Plate or Anchor Plate with Damper
6	Flashing	16	Roof Support
7	Storm Collar	17	Finishing Collar
8	Chimney Cap	18	DVL Adapter, DuraBlack Slip Connector, or Snap-Lock Adapter
9	Elbow	19	Stove Adapter
10	Elbow Strap		

Refer to our Typical Installation drawings to select the appropriate component parts for your installation.

- DVL/DuraBlack Chimney Adapter must be used when connecting DVL pipe to a Ceiling Support Box or Finishing Collar. When connecting DuraBlack pipe, a DVL/DuraBlack Chimney Adapter, DuraBlack Slip Connector, or Snap-Lock Adapter must be used.
- Wall Thimble must be installed with an appropriate length of chimney pipe for all horizontal through-the-wall installations. To accommodate thicker walls, the telescoping pieces of the Wall Thimble can be separated, and a field-fabricated extension may be installed.
- Attic Insulation Shield must be used in all installations that pass through an attic, regardless of whether the attic is insulated or not.
- Firestop Radiation Shield must be used when a chimney passes through a floor or ceiling without a support box.

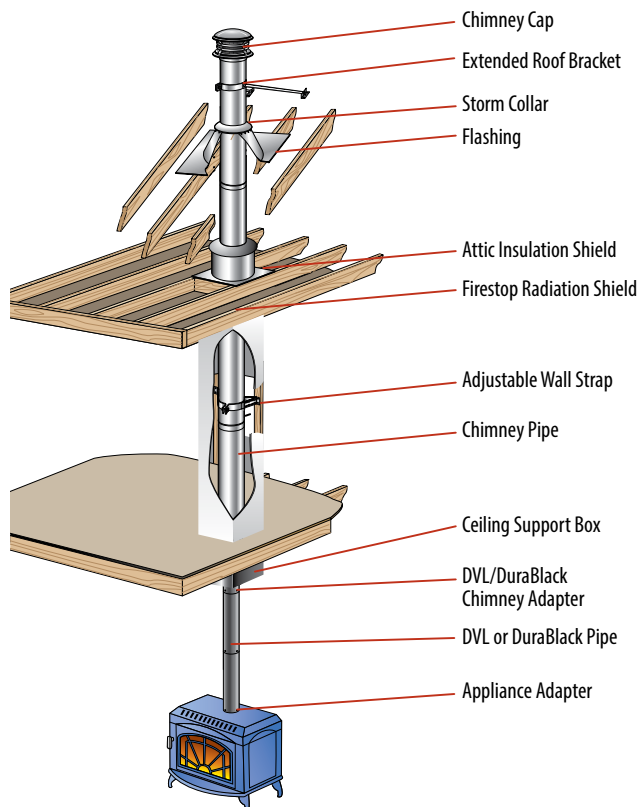

Planning Your Installation

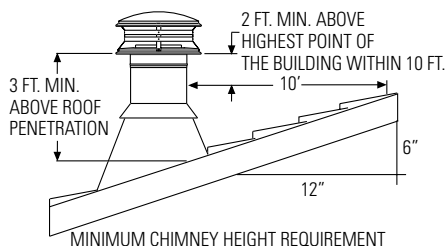

Figure 1

The following recommendations are general guideline to assist in the layout and selection of the chimney components needed for your installation. Always follow DuraVent Installation instructions before installing your chimney system, found with the cap or support box. Installation instructions can be viewed online at www.duravent.com, under catalogs and instructions.

- The diameter of the chimney should match the outlet size of the appliance. An improperly sized chimney results in poor draft and excessive creosote formation.
- Measure the diameter of the appliance flue outlet. Select the chimney and either DVL or DuraBlack connector stovepipe with the same size diameter as the appliance flue outlet. For fireplace installations, refer to the sizing chart in the back of this catalog.
- Determine if the installation is a through-the-roof installation or a through-the-wall installation. A through-the-wall installation will require additional components (Wall Thimble, Tee/ Cap, Tee Support, and Wall Straps).
- Install the chimney in the interior of the structure whenever possible. A cold exterior chimney will produce less draft and will generate more creosote.
- If possible avoid offsets that serve to restrict the natural draft. A straight vertical installation is more efficient and less likely to develop creosote. If an offset is required to avoid rafters or other obstructions, measure the horizontal distance required and the vertical height available. Both 15° and 30° elbows are available. Elbows have a 360° swivel base to allow orientation of elbow direction only. Elbows are fixed at 15° or 30°. Elbows greater than 30° are not allowed in the United States. A maximum of two offsets in a single installation are permitted. Refer to the offset table in the back section of this catalog. At least one Elbow Strap is required for each offset. Elbow Straps ensure adequate support.
- Determine the minimum chimney height above the roof line. Building codes require a minimum of 3' above the roof penetration and at least 2' higher than any portion of a building within 10'. See figure 1. The termination cap is installed above that point. If chimney extends 5' or more above the roof penetration an extended roof bracket is required. An additional roof bracket is needed every 5'.
- Measure the roof pitch. For example a 6/12 pitch has a vertical rise of 6" over a horizontal distance of 12". Select the appropriate flashing.
- Determine the total length of chimney and stovepipe required for the installation. To calculate the installed per length of 5"-8" DuraTech pipe, subtract 1 ¼" per joint. For 10"-24" diameter, subtract ¾" per joint of pipe. Subtract 1 ¼" per joint of DuraBlack stovepipe. Subtract 1 ½" per joint of DVL stovepipe. Minimum chimney height, at sea level, of straight vertical chimney is 10' to 15' above the appliance outlet. Higher elevations, or the use of elbows or a tee, will require approximately 30% to 60% more height to provide for an adequate draft.
- For a UL approved shroud, see the DuraTech Shrouds Installation Instructions (L157). View online at www.duravent.com, under catalogs and instructions.
- Be fire safe. Maintain at least 2" clearance to combustibles. Follow local building codes and have your chimney inspected by a certified professional.

What makes us different from the rest?

DuraTech: The optimum in safety and performance for an all-fuel chimney.



DuraTech Feature	Benefit	DuraTech Feature	Benefit	DuraTech Feature	Benefit
5" through 24" diameter selection	Gives the installer the largest variety of diameters to fit and size the fireplace or stove properly.	1" Thermal Tech Insulation Blanket	Insures complete insulation coverage between inner and outer walls, preventing any hot spots from appearing due to expansion of the metal walls during operation. Hot spots could cause a fire.	15 and 30 Degree Elbows come with swivel base	The swivel base allows an installer to line up the elbow without unlocking and repositioning the elbow, saving time and money.
6", 9", 12", 18", 24", 36", 48" and 60" pipe lengths	Gives the installer the greatest variety of lengths to reach the desired height with ease and least amount of pipe sections.			15 and 30 Degree Elbows come in kits	This insures that the installer gets both the offset and return elbow along with an elbow support bracket to make a properly code approved offset.
Twist Lock End Rings	Allows the installer to safely and easily connect and disconnect chimney sections without mechanical fasteners. Encases insulation to prevent exposure to outside elements. No locking bands required.	Factory Installed Starter Section in the Support Box	Allows the installer a safe, quick and easy connection of chimney to the support box.	Limited Lifetime Warranty	The best Warranty in the industry. 15 years 100%, 15 years and up 50% Gives the installer and home owner the greatest peace of mind in a quality installation.
430 Stainless Steel Inner Wall	Corrosion resistant stainless steel with the smallest amount of expansion when exposed to heat. Prevents hot spots from appearing which could cause a fire.	DuraTech offers 3 support box heights. 12", 24" 36" along with flat and round supports	Gives the installer the most options when dealing with ceiling slopes. Creating the most aesthetically pleasing installation possible.	Adjustable Tee and Wall Support Brackets	Guarantees proper clearance to combustibles, allowing the installer to work around changing exterior wall surfaces, avoiding any field fabrication or code violation.
.020" thick Stainless Steel Inner Wall	Thickest inner wall construction in the industry providing the best protection from creosote fires.	Reduced 10" wide Support Box for 6" diameter DuraTech	Allows for the smallest area of framing while still maintaining safe and approved clearances to combustibles. Could prevent having to reframe around chimney.	Shroud Specifications	Shroud specs allow the installer to create a UL listed shroud to hide the termination at the top of the chase for safest installation.
Light Weight Construction	Light weight Thermo Tech insulation makes pipe sections lighter (5lbs per ft for 6" diameter) to allow the manufacture of 5' lengths, thus the installer has fewer trips up the ladder for a quick and easy installation.			Dura-Vent offers 3 easy options to attachment Connector Pipe to Chimney System with the DVL/DB adapter, the DB slip connector or the snap lock adapter	Allows installer to connect DVL, DuraBlack or snap lock stovepipe to the support box or finishing collar for an easy and quick installation. Adapter snaps into support box and allows for easy disconnection and switching of connector pipe without disconnecting chimney.
1" Double Wall Insulated Pipe	Has the smallest outside diameter available to allow easy placement between studs. i.e. 8" O.D. on 6" diameter pipe. Saves from having to reframe around the chimney.			Removable Top Plate and Spark Arrestor on termination cap	Easy cleaning of chimney without having to disconnect and remove the cap. Saves time and money in cleaning.

DuraTech® 5"-8"

Chimney Pipe

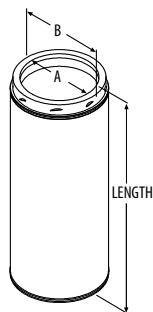

5" - 8" Diameters - Designed for appliances that are tested and listed for use with a 2100°F HT chimney system, such as wood stoves, fireplaces, furnaces, boilers, ranges, water heaters, or other appliances fueled by wood, oil, coal, or gas. Available in stainless steel (SS) or in a galvalume (GA) outer casing and stainless steel inner wall with twist-lock connections.

DuraTech 24", 36", 48", and 60" chimney pipe is available with additional protective carton filler for shipping. Available items have stock numbers with (CF).

SIZE	5"		6"		7"		8"	
	ORDER #	STOCK #	ORDER #	STOCK #	ORDER #	STOCK #	ORDER #	STOCK #
A	5"		6"		7"		8"	
B	7"		8"		9"		10"	
LENGTH								
6" GA	--	--	6DT-06	810000067	7DT-06	810000141	8DT-06	810000209
6" BLACK	5DT-06B	810000055	6DT-06B	810000068	7DT-06B	810000142	8DT-06B	810000210
6" SS	5DT-06SS	810000001	6DT-06SS	810000069	7DT-06SS	810000143	8DT-06SS	810000211
9" GA	--	--	6DT-09	810000070	7DT-09	810000144	8DT-09	810000212
9" BLACK	5DT-09B	810000002	6DT-09B	810000071	7DT-09B	810000145	8DT-09B	810000213
9" SS	5DT-09SS	810000003	6DT-09SS	810000072	7DT-09SS	810000146	8DT-09SS	810000214
12" GA	--	--	6DT-12	810000073	7DT-12	810000147	8DT-12	810000215
12" BLACK	5DT-12B	810000004	6DT-12B	810000074	7DT-12B	810000148	8DT-12B	810000216
12" SS	5DT-12SS	810000005	6DT-12SS	810000075	7DT-12SS	810000149	8DT-12SS	810000217
18" GA	--	--	6DT-18	810000076	7DT-18	810000150	8DT-18	810000218
18" SS	5DT-18SS	810000006	6DT-18SS	810000077	7DT-18SS	810000151	8DT-18SS	810000219
24" GA	--	--	6DT-24	810000078	7DT-24	810000152	8DT-24	810000220
24" GA	--	--	6DT-24CF	810000079	7DT-24CF	810000153	8DT-24CF	810000221
24" SS	5DT-24SS	810000008	6DT-24SS	810000080	7DT-24SS	810000154	8DT-24SS	810000222
24" SS	5DT-24SSCF	810000009	6DT-24SSCF	810000081	7DT-24SSCF	810000155	8DT-24SSCF	810000223
36" GA	--	--	6DT-36	810000082	7DT-36	810000156	8DT-36	810000224
36" GA	--	--	6DT-36CF	810000083	7DT-36CF	810000157	8DT-36CF	810000225
36" SS	5DT-36SS	810000010	6DT-36SS	810000084	7DT-36SS	810000158	8DT-36SS	810000226
36" SS	5DT-36SSCF	810000011	6DT-36SSCF	810000085	7DT-36SSCF	810000159	8DT-36SSCF	810000227
48" GA	--	--	6DT-48	810000086	7DT-48	810000160	8DT-48	810000228
48" GA	--	--	6DT-48CF	810000087	7DT-48CF	810000161	8DT-48CF	810000229
48" SS	5DT-48SS	810000012	6DT-48SS	810000088	7DT-48SS	810000162	8DT-48SS	810000230
48" SS	5DT-48SSCF	810000013	6DT-48SSCF	810000089	7DT-48SSCF	810000163	8DT-48SSCF	810000231
60" GA	--	--	6DT-60CF	810000090	7DT-60CF	810000164	8DT-60CF	810000232
60" SS	5DT-60SSCF	810000014	6DT-60SSCF	810000091	7DT-60SSCF	810000165	8DT-60SSCF	810000233

To calculate installed length of 5", 6", 7", or 8" DuraTech Chimney, subtract 1 1/4" from each joint overlap of chimney pipe. Allow a minimum of 2" air space to combustibles when installing DuraTech Chimney.

Adjustable Pipe

updated order #'s

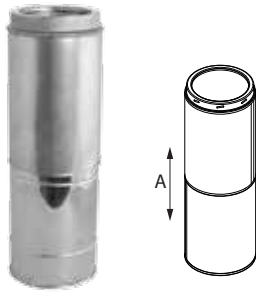

Use to add length to DuraTech chimney. Adjusts from 14"-21".

SIZE	6"	8"
A	14"-21"	
ORDER #	6DT-21TASS	8DT-21TASS
STOCK #	810000092	810000234

Elbow Kit



Elbow Kit includes: 2 Elbows and 1 Elbow Strap.

Use for offsets around obstructions such as rafters, ridgepoles, or joists. May have two pairs of elbows, if needed. Offsets greater than 30° are not permitted in accordance to UL 103 standards. Elbows swivel 360° at base (angles are not adjustable). A pair of elbows is required to return an offset chimney back to vertical.

Available in stainless steel (SS) or galvalume (GA) outer wall.

		15°	5"	6"	7"	8"
GA	ORDER #	--	6DT-E15K	7DT-E15K	8DT-E15K	
	STOCK #	--	810000093	810000166	810000235	
SS	ORDER #	5DT-E15KSS	6DT-E15KSS	7DT-E15KSS	8DT-E15KSS	
	STOCK #	810000015	810000094	810000167	810000236	
		30°	5"	6"	7"	8"
GA	ORDER #	--	6DT-E30K	7DT-E30K	8DT-E30K	
	STOCK #	--	810000095	810000168	810000237	
SS	ORDER #	5DT-E30KSS	6DT-E30KSS	7DT-E30KSS	8DT-E30KSS	
	STOCK #	810000016	810000096	810000169	810000238	

Elbow Strap

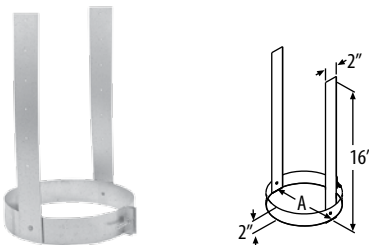

Use to prevent excessive weight on the elbows by supporting the weight of the chimney. Required to be installed between two elbows in offset installations. Multiple elbow straps may be required for offset installations. Refer to installation instructions.

SIZE	5"	6"	7"	8"
A	7"	8"	9"	10"
ORDER #	5DT-ES	6DT-ES	7DT-ES	8DT-ES
STOCK #	810000017	810000097	810000170	810000239

Square Ceiling Support Box

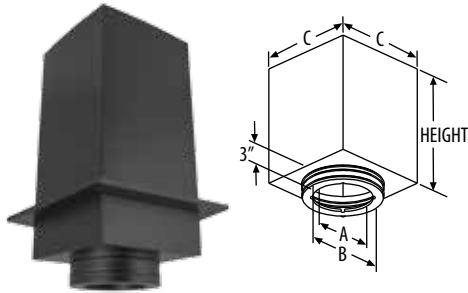

Supports chimney pipe and provides a positive connection between support box and chimney with a built-in twist-lock. Suitable for both flat and cathedral (A-Frame) ceiling applications. Also use in short attic spaces (see instructions). Fits between standard 16" on-center joists and most manufactured home applications. Supports up to 60' of DuraTech Chimney. Use adapter to attach DVL or DuraBlack to the support box. A 2" wide trim collar is included. Painted black. (For adapters see DVL/DuraBlack section.)

SIZE		5"	6"	7"	8"
A		5 1/4"	6 1/4"	7 1/4"	8 1/4"
B		9"	9"	11"	11"
C		11"	12"	13"	14 1/4"
HEIGHT					
11"	ORDER #	5DT-CS11	6DT-CS11	7DT-CS11	8DT-CS11
	STOCK #	810000018	810000098	810000171	810000240
24"	ORDER #	5DT-CS24	6DT-CS24	7DT-CS24	8DT-CS24
	STOCK #	810000019	810000099	810000172	810000241
36"	ORDER #	5DT-CS36	6DT-CS36	7DT-CS36	8DT-CS36
	STOCK #	810000020	810000100	810000173	810000242
CEILING PITCH					
DURABLACK		DVL		USE	
0/12 - 4/12		0/12 - 6/12		11" Support box	
5/12 - 9/12		7/12 - 13/12		24" Support box	
10/12 - 14/12		14/12 - 20/12		36" Support box	

Reduced Clearance Square Ceiling Support Box

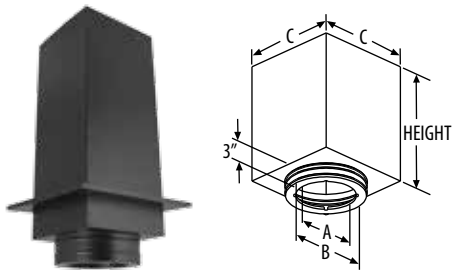

Supports chimney pipe and provides a positive connection between support box and chimney with a built-in twist-lock. Suitable for both flat and cathedral (A-Frame) ceiling applications. Also use in short attic spaces (see instructions). Fits between standard 12" on center joists and most manufactured home applications. Supports up to 60' of DuraTech Chimney. Use adapter to attach DVL or DuraBlack to the support box. A 2" wide trim collar is included. Painted black. (For adapters see DVL/DuraBlack section.)

SIZE		6"
A		6 1/4"
B		9"
C		10"
HEIGHT		
24"	ORDER #	6DT-CS24R
	STOCK #	810000101

Combustion Air Square Ceiling Support Box

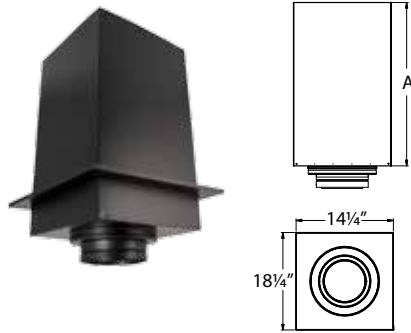

Use with Combustion Air System components. Delivers outdoor air as combustion air to the appliance. Operates as a direct vent system without requiring a second penetration to the building envelope. Black. Patent-pending. For pricing refer to the CAS price list.

SIZE	6"	6"	8"	8"
A	24"	36"	24"	36"
ORDER #	6CAS-CS24DT	6CAS-CS36DT	8CAS-CS24DT	8CAS-CS36DT
STOCK #	810000867	810000869	810000881	810000883

Round Ceiling Support Box



Supports chimney pipe and provides a positive connection between support box and chimney with a built-in twist-lock. Supports up to 60' of DuraTech Chimney. Use adapter to attach DVL or DuraBlack to the support box. Painted black. Trim collars are sold separately. (For adapters see DVL/DuraBlack section).

SIZE	5"	6"	7"	8"
A	5 1/4"	6 1/4"	7 1/4"	8 1/4"
B	9"	9"	11"	11"
C	11"	12"	13"	14"
ORDER #	5DT-RCS	6DT-RCS	7DT-RCS	8DT-RCS
STOCK #	810000021	810000102	810000174	810000243

Trim Collar For Round Support Box

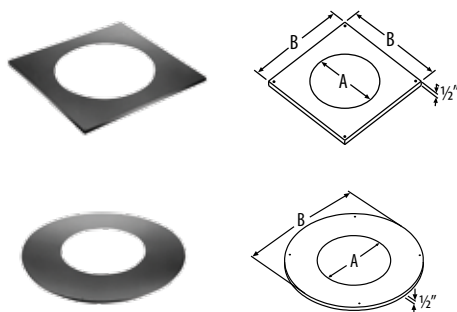

Conceals the gap between the Round Ceiling Support Box and the ceiling cutout. Select square or round. Painted black.

SQUARE TRIM COLLAR		
SIZE	5"- 6"	7"- 8"
A	9 1/8"	11 1/8"
B	14"	16"
ORDER #	5DT-TC	7DT-TC
STOCK #	810000022	810000175
ROUND TRIM COLLAR		
SIZE	5"- 6"	7"- 8"
A	9 1/8"	11 1/8"
B	17 1/2"	21"
ORDER #	5DT-TCR	7DT-TCR
STOCK #	810000023	810000176

Flat Ceiling Support Box

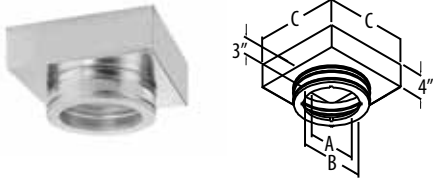

Supports chimney pipe and provides a positive connection between support box and chimney with a built-in twist-lock. Designed for installation in flat ceilings only. Supports up to 60' of DuraTech Chimney. Use adapter to attach DVL or DuraBlack to the support box. A 2" wide trim collar is included. Not painted, but can be painted with high temperature paint. (For adapters see DVL/DuraBlack section).

SIZE	5"	6"	7"	8"
A	5 1/4"	6 1/4"	7 1/4"	8 1/4"
B	9"	9"	11"	11"
C	11"	12"	13"	14 1/4"
ORDER #	5DT-FCS	6DT-FCS	7DT-FCS	8DT-FCS
STOCK #	810000024	810000103	810000177	810000244

Roof Support

updated description

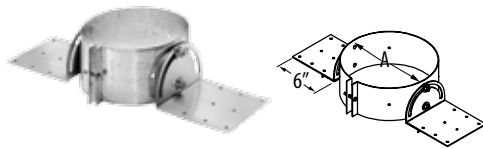

Designed to support the DuraTech Chimney and allows the chimney to pass through the roof and extend down from the ceiling. Ideal for cathedral ceilings and free-standing appliance installations. Supports up to a maximum total chimney length of 45' above and 20' chimney below Roof Support. Adjustable to different roof pitches. Use Finishing Collar and adapter to attach DVL or DuraBlack to the DuraTech chimney. Trim Collar not included.

SIZE	5"	6"	7"	8"
A	7"	8"	9"	10"
ORDER #	5DT-RS	6DT-RS	7DT-RS	8DT-RS
STOCK #	810000025	810000104	810000178	810000245

Trim Collar For Roof Support

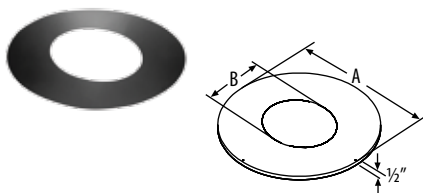

Conceals gap between chimney pipe and ceiling cut out when used with Roof Support. Galvalume. Painted black.

SIZE		5"	6"	7"	8"
A		18"	18"	20"	20"
B		7 1/4"	8 1/4"	9 1/4"	10 1/4"
0/12 - 3/12	ORDER #	5DT-RSTC3	6DT-RSTC3	7DT-RSTC3	8DT-RSTC3
	STOCK #	810000026	810000105	810000179	810000246
4/12 - 6/12	ORDER #	5DT-RSTC6	6DT-RSTC6	7DT-RSTC6	8DT-RSTC6
	STOCK #	810000027	810000106	810000180	810000247
7/12 - 9/12	ORDER #	5DT-RSTC9	6DT-RSTC9	7DT-RSTC9	8DT-RSTC9
	STOCK #	810000028	810000107	810000181	810000248
10/12 - 12/12	ORDER #	5DT-RSTC12	6DT-RSTC12	7DT-RSTC12	8DT-RSTC12
	STOCK #	810000029	810000108	810000182	810000249

Support Box Rails

new product offering

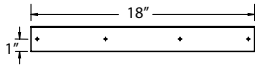

Attach to outside of Square Ceiling Support Box to provide level, temporary support. This enables an installer to easily fasten the box in place without the need for another pair of hands. Simplifies installation.

SIZE	6"
ORDER #	6DT-SBRU
STOCK #	810007036

Wall Thimble

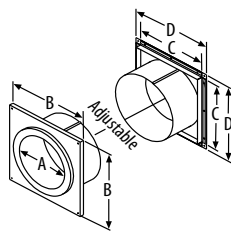

Adjusts from a minimum of 4" to a maximum of 10" wall thickness, and fits between standard wall studs. To accommodate thicker walls, the telescoping pieces can be extended up to 16" with a field-fabricated extension installed. Interior trim ring painted black. Must be installed with DuraTech chimney pipe horizontally through the wall and extend 6" into the room beyond the interior wall. (Black painted DuraTech is available). 6" and 8" stainless steel exterior trim available.

SIZE	5"	6"	7"	8"
A	7 1/8"	8 1/8"	9 1/8"	10 1/8"
B	14"	14"	16"	16"
C	10 7/8"	11 7/8"	12 7/8"	13 7/8"
D	13"	14"	15"	16"
ORDER #	5DT-WT	6DT-WT	7DT-WT	8DT-WT
STOCK #	810000030	810000109	810000183	810000250
SS TRIM	5"	6"	7"	8"
ORDER #	--	6DT-WTSS	--	8DT-WTSS
STOCK #	--	810000110	--	810000251

Combustion Air Wall Thimble

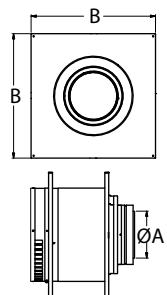

Use with Combustion Air System components. Delivers outdoor air as combustion air to the appliance. Operates as a direct vent system without requiring a second penetration to the building envelope. Black. Patent-pending.

SIZE	6"	8"
A	6"	8"
B	16"	18"
ORDER #	6CAS-WTDT	8CAS-WTDT
STOCK #	810000865	810000879

Tee w/Cap

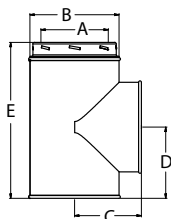

Use for through-the-wall installations. Includes removable tee cap for easy chimney cleaning or inspection. Wall Straps, a Wall Thimble, and an Adjustable Tee Support Bracket must be installed with the Tee as directed. Available in stainless steel or with a galvalume outer wall and stainless steel inner wall. See installation instructions for proper location and installation of Tee.

SIZE		5"	6"	7"	8"
A		5"	6"	7"	8"
B		7"	8"	9"	10"
C		5 1/2"	6 1/8"	6 1/2"	7 1/8"
D		6"	6 1/2"	7 1/2"	7 3/4"
E		12 3/8"	13 7/8"	14 1/4"	15 1/4"
GA	ORDER #	--	6DT-ST	7DT-ST	8DT-ST
	STOCK #	--	810000113	810000186	810000254
SS	ORDER #	5DT-STSS	6DT-STSS	7DT-STSS	8DT-STSS
	STOCK #	810000036	810000114	810000187	810000255

Adjustable Tee Support Bracket

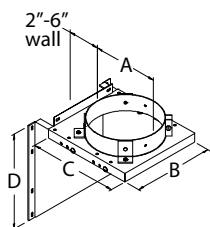

Use as wall support for chimney system. Use of straps is optional. Supports up to 50' of DuraTech Chimney without straps, and 70' of DuraTech Chimney with straps. Attaches to chimney pipe. Can be installed above or below the Tee. If installed below the Tee, a short section of pipe is required. Adjustable base provides 2" to 6" clearance to wall.

SIZE		5"	6"	7"	8"
A		7"	8"	9"	10"
B		10"	10"	12"	12"
C		11"	11"	13"	13"
D		11 3/4"	11 3/4"	13 3/4"	13 3/4"
GA	ORDER #	5DT-TSB	6DT-TSB	7DT-TSB	8DT-TSB
	STOCK #	810000033	810000111	810000184	810000252
SS	ORDER #	5DT-TSBSS	6DT-TSBSS	7DT-TSBSS	8DT-TSBSS
	STOCK #	810000034	810000112	810000185	810000253

Adjustable Wall Strap

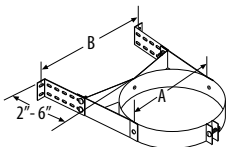

Use in interior or exterior installations to add lateral support to the chimney. Assures a 2" to 6" clearance to combustible walls. Required every 8'.

SIZE		5"	6"	7"	8"
A		7"	8"	9"	10"
B		10 3/4"	11 3/4"	12 7/8"	14"
GA	ORDER #	5DT-WS	6DT-WS	7DT-WS	8DT-WS
	STOCK #	810000052	810000137	810000205	810000278
SS	ORDER #	5DT-WSSS	6DT-WSSS	7DT-WSSS	8DT-WSSS
	STOCK #	810000053	810000138	810000206	810000279

Finishing Collar w/ Adapter



New integrated collar with adapter, fits into the female end of the chimney pipe to provide a decorative black finish. Use on chimney pipe that is suspended with the roof support system or on pipe that is passing through a wall thimble. Provides connection to black DVL or DuraBlack.

SIZE	5"	6"	7"	8"
ORDER #	5DT-FC	6DT-FC	7DT-FC	8DT-FC
STOCK #	810000037	810000115	810000188	810000256

Anchor Plate

updated description

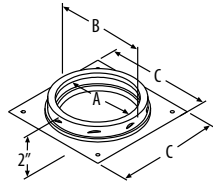

Use to attach DuraTech Chimney to an appliance or masonry fireplace. Check with appliance manufacturer to ensure DuraTech Chimney is approved for use.

SIZE	5"	6"	7"	8"
A	5"	6"	7"	8"
B	7"	8"	9"	10"
C	9"	10"	11"	12"
ORDER #	5DT-AP	6DT-AP	7DT-AP	8DT-AP
STOCK #	810000038	810000116	810000189	810000257

Transition Anchor Plate

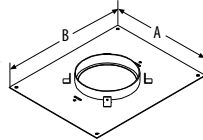
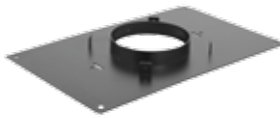

Use when converting from DuraLiner to DuraTech in chimney restoration. Use with a DuraLiner Slip Connector and Hanger (See DuraLiner section).

SIZE	6"	6"	6"	6"
A	14"	17"	13"	17"
B	17"	17"	21"	21"
ORDER #	6DT-AP14x17	6DT-AP17x17	6DT-AP13x21	6DT-AP17x21
STOCK #	810000117	810000118	810000119	810000120
SIZE	8"	8"	8"	8"
A	14"	17"	13"	17"
B	17"	17"	21"	21"
ORDER #	8DT-AP14x17	8DT-AP17x17	8DT-AP13x21	8DT-AP17x21
STOCK #	810000258	810000259	810000260	810000261

Firestop Radiation Shield

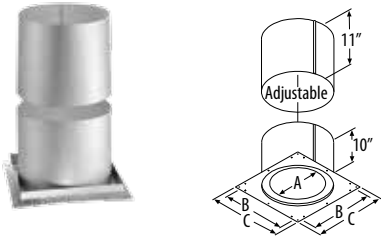

Use in ceiling/floor penetrations when a ceiling support is not used. Not required when passing through the roof. Fits on underside of ceiling and adjusts to cover framing.

SIZE	5"	6"	7"	8"
A	7 1/8"	8 1/8"	9 1/8"	10 1/8"
B	10 7/8"	11 7/8"	12 7/8"	13 7/8"
C	13"	14"	15"	16"
ORDER #	5DT-FRS	6DT-FRS	7DT-FRS	8DT-FRS
STOCK #	810000039	810000121	810000190	810000262

Attic Insulation Shield

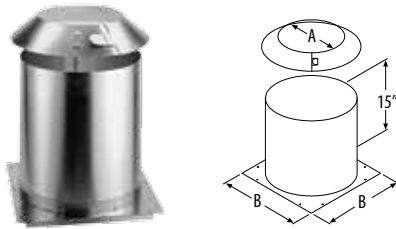

Required for installations that pass through an attic to prevent insulation and debris from accumulating near the chimney. Fits over Firestop Radiation Shield or a support box. Consists of two parts – a collar and a base.

SIZE	5"	6"	7"	8"
A	7"	8"	9"	10"
B	13"	14"	15"	16"
ORDER #	5DT-IS	6DT-IS	7DT-IS	8DT-IS
STOCK #	810000040	810000122	810000191	810000263

Roof Radiation Shield

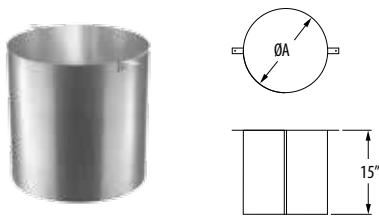

Install where a chimney passes through a roof. May be required for Canadian zero-clearance fireplaces, refer to appliance manufacturer's installation instructions.

SIZE	5"	6"	7"	8"
A	9"	10"	11"	12"
ORDER #	5DT-RRS	6DT-RRS	7DT-RRS	8DT-RRS
STOCK #	810000041	810000123	810000192	810000264

Chase Top Flashing

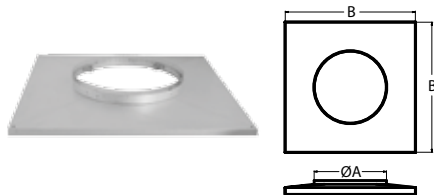

Encloses the top of a chase while providing a ventilation air passage from the chase. UL Listed. Includes spacer clips. Storm collar not included. Made of galvalume.

SIZE	5"	6"	7"	8"
A	10"	11"	12"	13"
B	18 3/4"	19 3/4"	20 3/4"	21 3/4"
ORDER #	5DT-CTF	6DT-CTF	7DT-CTF	8DT-CTF
STOCK #	810000042	810000124	810000193	810000265

Extended Roof Bracket

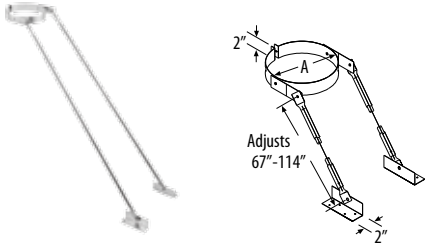

Use to support the chimney when it extends more than 5' above the roof. Provides stability to chimney against wind and snow. Mounting brackets and adjustable tubing included.

SIZE	5"	6"	7"	8"
A	7"	8"	9"	10"
ORDER #	5DT-XRB	6DT-XRB	7DT-XRB	8DT-XRB
STOCK #	810000044	810000125	810000195	810000266

DSA Roof Flashings



Use with metal or tile roofs. Available in sizes 6" and 8" in large base 0/12-6/12 (shown) and 7/12-12/12 styles. Made of dead soft aluminum. Refer to Roof Flashing table for dimensions.

STOCK #		6"	8"
0/12 - 6/12	ORDER #	6DT-F6DSA	8DT-F6DSA
	STOCK #	810000127	810000268
7/12 - 12/12	ORDER #	6DT-F12DSA	8DT-F12DSA
	STOCK #	810000129	810000270

Roof Flashing

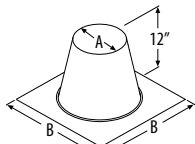
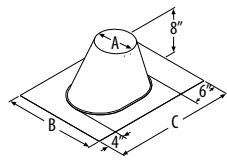

Flat Roof Flashing

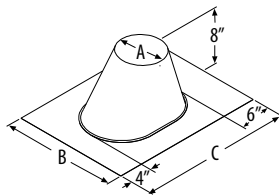

Large Base Adjustable Flashing

Use to weather proof the penetration of chimney pipe through the roof. Storm Collar required. Select roof flashing based on pitch of roof. For example, a 6/12 pitch has a vertical rise of 6" over a horizontal distance of 12". Made of galvalume. 6"-8" available with large base.

ADJUSTABLE SIZE		5"	6"	7"	8"
0/12 - 6/12	A	7 1/2"	8 1/2"	9 1/2"	10 1/2"
	B	19"	20"	21"	22"
	C	26"	27 3/16"	28 3/16"	29 1/2"
	ORDER #	5DT-F6	6DT-F6	7DT-F6	8DT-F6
	STOCK #	810000045	810000126	810000196	810000267
7/12 - 12/12	A	7 1/2"	8 1/2"	9 1/2"	10 1/2"
	B	19"	20"	21"	22"
	C	28 3/16"	30"	31 3/16"	33 1/4"
	ORDER #	5DT-F12	6DT-F12	7DT-F12	8DT-F12
	STOCK #	810000046	810000128	810000197	810000269
13/12 - 18/12	A	7 1/2"	8 1/2"	9 1/2"	10 1/2"
	B	19"	20"	21"	22"
	C	32 3/16"	34 3/8"	36 3/16"	38"
	ORDER #	5DT-F18	6DT-F18	7DT-F18	8DT-F18
	STOCK #	810000047	810000130	810000198	810000271
19/12 - 24/12	A	7 1/2"	8 1/2"	9 1/2"	10 1/2"
	B	19"	20"	21"	22"
	C	37 3/16"	39 1/2"	41 3/4"	44"
	ORDER #	5DT-F24	6DT-F24	7DT-F24	8DT-F24
	STOCK #	810000048	810000131	810000199	810000272
FLAT ROOF		5"	6"	7"	8"
	A	7 1/4"	8 1/4"	9 1/4"	10 1/4"
	B	19 7/16"	20 11/16"	21 5/8"	21 5/8"
	ORDER #	5DT-FF	6DT-FF	7DT-FF	8DT-FF
	STOCK #	810000049	810000132	810000200	810000273
LRG BASE ADJUSTABLE SIZE		5"	6"	7"	8"
0/12 - 6/12	A	--	8 1/4"	9 1/4"	10 1/4"
	B	--	28"	29"	30"
	C	--	27"	28"	29"
	ORDER #	--	6DT-F6L	7DT-F6L	8DT-F6L
	STOCK #	--	810000133	810000201	810000274
7/12 - 12/12	A	--	8 1/4"	9 1/4"	10 1/4"
	B	--	28"	29"	30"
	C	--	30"	31"	33"
	ORDER #	--	6DT-F12L	7DT-F12L	8DT-F12L
	STOCK #	--	810000134	810000202	810000275

Storm Collar

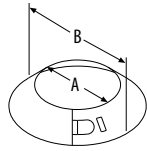

Required with DuraTech flashing to create a weather-proof penetration through the roof deck. Seal inner edge of the collar to the chimney pipe with non-hardening 500° F high-temperature sealant. Made of aluminum.

SIZE	5" - 6"	7" - 8"
A	7" - 8"	9" - 10"
B	12" - 14"	15" - 16"
ORDER #	5DT-SC	7DT-SC
STOCK #	810000043	810000194

Chimney Cap

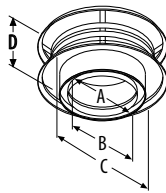

Required where pipe terminates above the roof line. Removable screws allow for cleaning of the chimney and spark arrestor screen. Made of stainless steel. See with optional Spark Arrestor screen below.

SIZE	5"	6"	7"	8"
A	5"	6"	7"	8"
B	7"	8"	9"	10"
C	11"	11"	15"	15"
D	6 1/2"	6 1/2"	6 1/2"	6 1/2"
ORDER #	5DT-VC	6DT-VC	7DT-VC	8DT-VC
STOCK #	810000050	810000135	810000203	810000276

Spark Arrestor



Use on inside of cap. Optional Spark Arrestor may be required.

SIZE	5" - 8"
ORDER #	5DT-SA
STOCK #	810000054

Locking Band

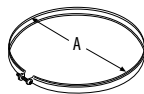

Use for extra security at pipe, elbow, and tee joints. Optional.

SIZE	5"	6"	7"	8"
A	7"	8"	9"	10"
ORDER #	5DT-LB	6DT-LB	7DT-LB	8DT-LB
STOCK #	810000051	810000136	810000204	810000277

Chase Air Intake w/ Rodent Guard

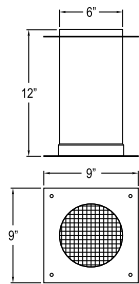
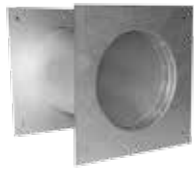

Allows required ventilation air into chase. Screen keeps rodents out.

SIZE	6"
ORDER #	6DT-CAI
STOCK #	810005052

Snow Splitter

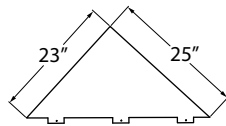
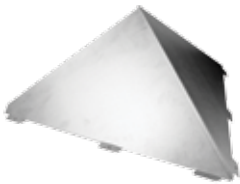

Use to divert snow around chimney, vent, and roof flashing. Constructed of paintable galvanized material. Ships flat for easy assembly.

SIZE	6"
ORDER #	6DT-SP
STOCK #	810000139

DuraTech® 10"-24"

Chimney Pipe

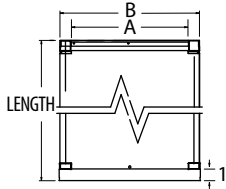

To calculate installed length of 10", 12", 14", 16", 18", 20", 22" or 24" DuraTech Chimney, subtract 1" from each joint overlap of chimney pipe. Important: Allow a minimum of 2" air space to combustibles when installing DuraTech Chimney.

10" - 24" Diameters - Designed for appliances that are tested and listed for use with a 1700°F rated chimney system, such as zero-clearance or masonry fireplaces, furnaces, boilers, water heaters, ranges, or other appliances fueled by oil, coal, gas, or wood. Tested to UL 103 and listed under MH 7399. Available in galvalume (GA) and stainless steel (SS) outer wall and stainless steel inner wall. Requires fastening with screws.

DuraTech (10"-16" diameters) 24" and 36" chimney pipe is available with additional protective carton filler for shipping. Available items have stock numbers with (CF). 18"-24" diameters are built to order and are not returnable.

SIZE	10"		12"		14"	
	ORDER #	STOCK #	ORDER #	STOCK #	ORDER #	STOCK #
A	10"		12"		14"	
B	12"		14"		16"	
6" GA	10DT-06	810000282	12DT-06	810000320	14DT-06	810000354
12" GA	10DT-12	810000283	12DT-12	810000321	14DT-12	810000355
12" SS	10DT-12SS	810000284	12DT-12SS	810000322	14DT-12SS	810000356
18" GA	10DT-18	810000285	12DT-18	810000323	14DT-18	810000357
18" SS	10DT-18SS	810000286	12DT-18SS	810000324	14DT-18SS	810000358
24" GA	10DT-24	810000287	12DT-24	810000325	14DT-24	810000359
24" GA	10DT-24CF	810000288	12DT-24CF	810000326	--	--
24" SS	10DT-24SS	810000289	12DT-24SS	810000327	14DT-24SS	810000360
36" GA	10DT-36	810000290	12DT-36	810000328	14DT-36	810000361
36" GA	10DT-36CF	810000291	12DT-36CF	810000329	--	--
36" SS	10DT-36SS	810000292	12DT-36SS	810000330	14DT-36SS	810000362

SIZE	16"		18"		20"		22"		24"	
	ORDER #	STOCK #	ORDER #	STOCK #	ORDER #	STOCK #	ORDER #	STOCK #	ORDER #	STOCK #
A	16"		18"		20"		22"		24"	
B	18"		20"		22"		24"		26"	
6" GA	16DT-06	810000386	--	--	--	--	--	--	--	--
12" GA	16DT-12	810000387	18DT-12	810000418	20DT-12	810000442	22DT-12	810000466	24DT-12	810000489
12" SS	16DT-12SS	810000388	18DT-12SS	810000419	20DT-12SS	810000443	22DT-12SS	810000467	24DT-12SS	810000490
18" GA	16DT-18	810000389	18DT-18	810000420	20DT-18	810000444	22DT-18	810000468	24DT-18	810000491
18" SS	16DT-18SS	810000390	18DT-18SS	810000421	20DT-18SS	810000445	22DT-18SS	810000469	24DT-18SS	810000492
24" GA	16DT-24	810000391	18DT-24	810000422	20DT-24	810000446	22DT-24	810000470	24DT-24	810000493
24" SS	16DT-24SS	810000392	18DT-24SS	810000423	20DT-24SS	810000447	22DT-24SS	810000471	24DT-24SS	810000494
36" GA	16DT-36	810000393	18DT-36	810000424	20DT-36	810000448	22DT-36	810000472	24DT-36	810000495
36" SS	16DT-36SS	810000394	18DT-36SS	810000425	20DT-36SS	810000449	22DT-36SS	810000473	24DT-36SS	810000496

15° Elbow

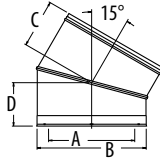

Use for offsets around obstructions such as rafters, ridgepoles, or joists. May have one pair of elbows if needed. Offsets greater than 30° are not permitted in accordance to UL 103 standards. Large diameters are restricted to one pair of elbows.

Available in galvalume (GA) and stainless steel (SS) outer wall and stainless steel inner wall. Fasten with screws.

SIZE		10"	12"	14"	16"
A		10"	12"	14"	16"
B		12"	14"	16"	18"
C		6 3/4"	6 3/4"	6 3/4"	7 1/4"
D		7"	7"	7"	6 1/2"
GA	ORDER #	10DT-E15	12DT-E15	14DT-E15	16DT-E15
	STOCK #	810000293	810000331	810000363	810000395
SS	ORDER #	10DT-E15SS	12DT-E15SS	14DT-E15SS	16DT-E15SS
	STOCK #	810000294	810000332	810000364	810000396
SIZE		18"	20"	22"	24"
A		18"	20"	22"	24"
B		20"	22"	24"	26"
C		9"	9"	9"	9"
D		9"	9"	9"	9"
GA	ORDER #	18DT-E15	20DT-E15	22DT-E15	24DT-E15
	STOCK #	810000426	810000450	810000474	810000497
SS	ORDER #	18DT-E15SS	20DT-E15SS	22DT-E15SS	24DT-E15SS
	STOCK #	810000427	810000451	810000475	810000498

30° Elbow

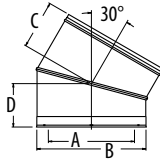

Use for offsets around obstructions such as rafters, ridgepoles, or joists. May have one pair of elbows if needed. Offsets greater than 30° are not permitted in accordance to UL 103 standards. Large diameters are restricted to one pair of elbows.

Available in galvalume (GA) and stainless steel (SS) outer wall and stainless steel inner wall. Fasten with screws.

SIZE		10"	12"	14"	16"
A		10"	12"	14"	16"
B		12"	14"	16"	18"
C		5 7/8"	6 1/8"	6 3/8"	6 5/8"
D		6 5/8"	6 7/8"	7 1/8"	7 3/8"
GA	ORDER #	10DT-E30	12DT-E30	14DT-E30	16DT-E30
	STOCK #	810000295	810000333	810000365	810000397
SS	ORDER #	10DT-E30SS	12DT-E30SS	14DT-E30SS	16DT-E30SS
	STOCK #	810000296	810000334	810000366	810000398
SIZE		18"	20"	22"	24"
A		18"	20"	22"	24"
B		20"	22"	24"	26"
C		9"	9"	9"	9"
D		9"	9"	9"	9"
GA	ORDER #	18DT-E30	20DT-E30	22DT-E30	24DT-E30
	STOCK #	810000428	810000452	810000476	810000499
SS	ORDER #	18DT-E30SS	20DT-E30SS	22DT-E30SS	24DT-E30SS
	STOCK #	810000429	810000453	810000477	810000500

Elbow Strap

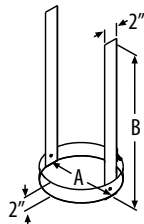

Use to prevent excessive weight on the elbows by supporting the weight of the chimney. Required to be installed between two elbows in offset installations. Multiple elbow straps may be required for offset installations. Refer to installation instructions.

SIZE	10"	12"	14"	16"
A	12"	14"	16"	18"
B	30"	30"	30"	30"
ORDER #	10DT-ES	12DT-ES	14DT-ES	16DT-ES
STOCK #	810000297	810000335	810000367	810000399
SIZE	18"	20"	22"	24"
A	20"	22"	24"	26"
B	36"	36"	36"	36"
ORDER #	18DT-ES	20DT-ES	22DT-ES	24DT-ES
STOCK #	810000430	810000454	810000478	810000501

Round Ceiling Support Box

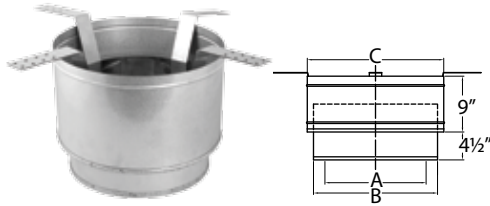

Supports chimney pipe and provides a positive connection between support box and chimney. Supports up to 40' of DuraTech Chimney. Trim collars are sold separately. (For 10" use DuraBlack Slip Connector to attach DuraBlack to the support box. See DuraBlack section).

SIZE	10"	12"	14"	16"
A	10 5/16"	12 5/16"	14 5/16"	16 5/16"
B	14"	16"	18"	20"
C	16"	18"	20"	22"
ORDER #	10DT-RCS	12DT-RCS	14DT-RCS	16DT-RCS
STOCK #	810000298	810000336	810000368	810000400

Trim Collar For Round Support Box

updated order numbers

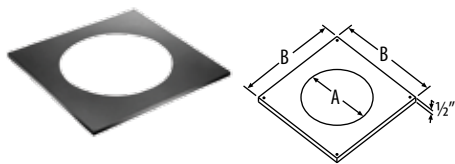

Conceals gap between chimney pipe and ceiling cut-out when used with Round Ceiling Support Box. Galvalume. Painted black.

SIZE	10"	12"	14"	16"
A	14 1/4"	16 1/4"	18 1/4"	20 1/4"
B	20"	22"	24"	26"
ORDER #	10DT-TCR	12DT-TCR	14DT-TCR	16DT-TCR
STOCK #	810000299	810000337	810000369	810000401

Wall Thimble

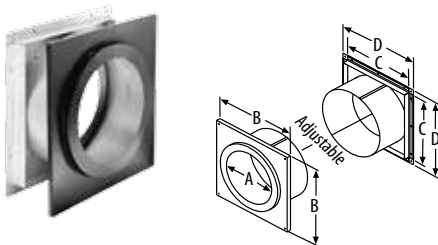

Use to provide clearance to combustibles. Adjusts from a minimum of 4" to a maximum of 10" wall thickness, and fits between standard wall studs. To accommodate thicker walls, the telescoping pieces can be extended up to 16" with a field-fabricated extension installed. Interior trim ring painted black. Must be installed with DuraTech chimney pipe horizontally through the wall and extend 6" into the room beyond the interior wall.

SIZE	10"	12"	14"	16"
A	12 1/8"	14 1/8"	16 1/8"	18 1/8"
B	20"	22"	24"	26"
C	15 7/8"	17 7/8"	19 7/8"	21 1/8"
D	18"	20"	22"	24"
ORDER #	10DT-WT	12DT-WT	14DT-WT	16DT-WT
STOCK #	810000300	810000338	810000370	810000402

Tee w/ Cap

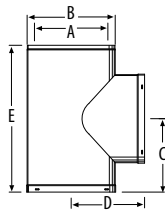

Use for through-the-wall installations. Includes removable Tee Cap for easy chimney cleaning or inspection. Wall Straps, a Wall Thimble, and an Adjustable Tee Support Bracket must be installed with the Tee as directed. Available in stainless steel or with a galvalume outer wall and stainless steel inner wall. 18"-24" Tee is not UL listed. See installation instructions for proper location and installation of Tee.

SIZE	10"	12"	14"	16"	
A	10"	12"	14"	16"	
B	12"	14"	16"	18"	
C	10"	11"	12"	13"	
D	10"	11"	12"	13"	
E	20"	22"	24"	26"	
GA	ORDER #	10DT-T	12DT-T	14DT-T	16DT-T
	STOCK #	810000301	810000339	810000371	810000403
SS	ORDER #	10DT-TSS	12DT-TSS	14DT-TSS	16DT-TSS
	STOCK #	810000302	810000340	810000372	810000404
SIZE	18"	20"	22"	24"	
A	18"	20"	22"	24"	
B	20"	22"	24"	26"	
C	14"	15"	16"	17"	
D	14"	15"	16"	17"	
E	28"	30"	32"	34"	
GA	ORDER #	18DT-T	20DT-T	22DT-T	24DT-T
	STOCK #	810000439	810000463	810000486	810000509
SS	ORDER #	18DT-TSS	20DT-TSS	22DT-TSS	24DT-TSS
	STOCK #	810000440	810000464	810000487	810000510

Tee Support Bracket

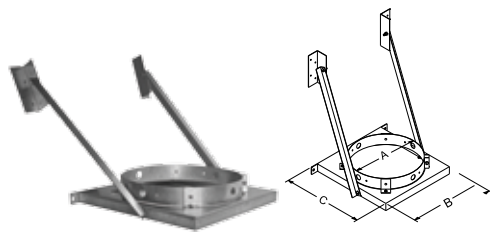

Use as wall support for chimney system. Supports up to 30' of DuraTech Chimney. Attaches to chimney pipe. Can be installed above or below the Tee. If installed below the Tee, a short section of pipe is required.

SIZE	10"	12"	14"	16"
A	12"	14"	16"	18"
B	14"	16"	18"	20"
C	15 1/8"	17 1/8"	19 1/8"	21 1/8"
ORDER #	10DT-TSB	12DT-TSB	14DT-TSB	16DT-TSB
STOCK #	810000303	810000341	810000373	810000405

Wall Strap

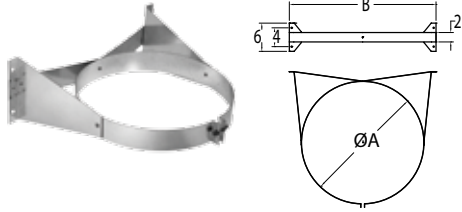

Use in interior or exterior installations to add lateral support to the chimney. Assures a 2" clearance to combustible walls. Required every 4'.

SIZE	10"	12"	14"	16"
A	12"	14"	16"	18"
B	16"	18"	20"	22"
ORDER #	10DT-WS	12DT-WS	14DT-WS	16DT-WS
STOCK #	810000316	810000353	810000385	810000417
SIZE	18"	20"	22"	24"
A	20"	22"	24"	26"
B	23"	25"	27"	29"
ORDER #	18DT-WS	20DT-WS	22DT-WS	24DT-WS
STOCK #	810000441	810000465	810000488	810000511

Finishing Collar



Fits over the female end of the chimney pipe to provide a decorative black finish. Use on chimney pipe that is suspended with the roof support system or on pipe that is passing through a wall thimble.

SIZE	10"
A	10"
B	12"
ORDER #	10DT-FC
STOCK #	810000304

Anchor Plate

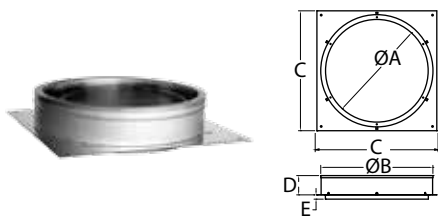

Use as a starter section for DuraTech. Bolts directly to masonry fireplace outlet.

SIZE	10"	12"	14"	16"
A	10"	12"	14"	16"
B	12 1/16"	14 1/16"	16 1/16"	18 1/16"
C	14"	16"	18"	20"
D	7/8"	7/8"	7/8"	7/8"
E	1"	1"	1"	1"
ORDER #	10DT-AP	12DT-AP	14DT-AP	16DT-AP
STOCK #	810000305	810000342	810000374	810000406
SIZE	18"	20"	22"	24"
A	18"	20"	22"	24"
B	20 1/16"	22 1/16"	24 1/16"	26 1/16"
C	22"	24"	26"	28"
D	1"	1"	1"	1"
E	1"	1"	1"	1"
ORDER #	18DT-AP	20DT-AP	22DT-AP	24DT-AP
STOCK #	810000431	810000455	810000479	810000502

Anchor Plate w/ Damper

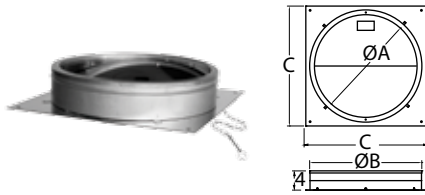

Use as a starter section for DuraTech. Bolts directly to fireplace outlet. Damper section allows chimney to be closed when fireplace is not in use. Includes chain and lintel hook.

SIZE	10"	12"	14"	16"
A	10"	12"	14"	16"
B	12"	14"	16"	18"
C	14"	16"	18"	20"
ORDER #	10DT-APD	12DT-APD	14DT-APD	16DT-APD
STOCK #	810000306	810000343	810000375	810000407
SIZE	18"	20"	22"	24"
A	18"	20"	22"	24"
B	20"	22"	24"	26"
C	22"	24"	26"	28"
ORDER #	18DT-APD	20DT-APD	22DT-APD	24DT-APD
STOCK #	810000432	810000456	810000480	810000503

Firestop Radiation Shield

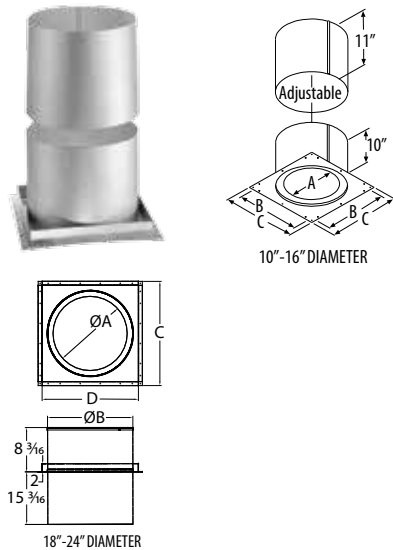

Use in ceiling/floor penetrations other than those that include the ceiling support. Fits on underside of ceiling and adjusts to cover framing.

SIZE	10"	12"	14"	16"
A	12 1/8"	14 1/8"	16 1/8"	18 1/8"
B	15 7/8"	17 7/8"	19 7/8"	21 7/8"
C	18"	20"	22"	24"
D	--	--	--	--
ORDER #	10DT-FRS	12DT-FRS	14DT-FRS	16DT-FRS
STOCK #	810000307	810000344	810000376	810000408
SIZE	18"	20"	22"	24"
A	20 1/8"	22 1/8"	24 1/8"	26 1/8"
B	23"	25"	27"	29"
C	26"	28"	30"	32"
D	24"	26"	28"	30"
ORDER #	18DT-FRS	20DT-FRS	22DT-FRS	24DT-FRS
STOCK #	810000433	810000457	810000481	810000504

Attic Insulation Shield

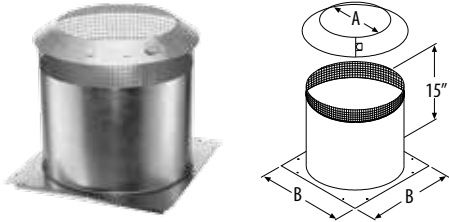

Use in installations that pass through an attic to prevent insulation and debris from accumulating near the chimney, unless chimney is enclosed through attic. Fits over Firestop Radiation Shield or a support box. Consists of two parts – a collar and a base. Mesh sleeve around top.

SIZE	10"	12"	14"	16"
A	12"	14"	16"	18"
B	18"	20"	22"	24"
ORDER #	10DT-IS	12DT-IS	14DT-IS	16DT-IS
STOCK #	810000308	810000345	810000377	810000409
SIZE	18"	20"	22"	24"
A	20"	22"	24"	26"
B	26"	28"	30"	32"
ORDER #	18DT-IS	20DT-IS	22DT-IS	24DT-IS
STOCK #	810000434	810000458	810000482	810000505

Roof Radiation Shield

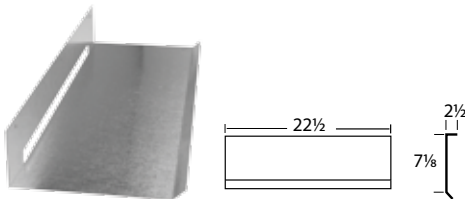

Required at top of chase enclosure or where chimney passes through the roof. Not required if chimney is unenclosed in the attic. Four plates (included) make up one shield.

SIZE	STOCK #
18" - 24"	18DT-RRS
STOCK #	810000435

Chase Top Flashing

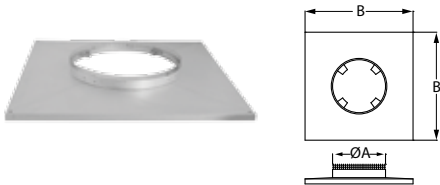

Encloses the top of a chase while providing a ventilation air passage from the chase. UL Listed. Includes spacer clips. Storm collar not included. Made of galvalume.

SIZE	10"	12"	14"	16"
A	15"	17"	19"	21"
B	34"	36"	38"	40"
ORDER #	10DT-CTF	12DT-CTF	14DT-CTF	16DT-CTF
STOCK #	810000309	810000346	810000378	810000410
SIZE	18"	20"	22"	24"
A	20"	22"	24"	26"
B	40"	40"	40"	40"
ORDER #	18DT-CTF	20DT-CTF	22DT-CTF	24DT-CTF
STOCK #	810000436	810000459	810000483	810000506

Extended Roof Bracket

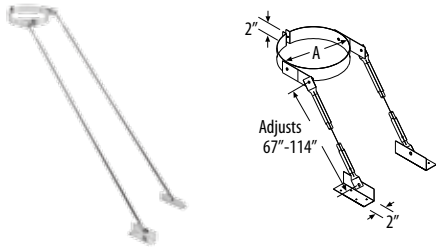

Use to support the chimney when it extends more than 5' above the roof. Provides stability to chimney against wind and snow. Mounting brackets and adjustable tubing included.

SIZE	10"	12"	14"	16"
A	12"	14"	16"	18"
ORDER #	10DT-XRB	12DT-XRB	14DT-XRB	16DT-XRB
STOCK #	810000310	810000347	810000379	810000411

Roof Flashings

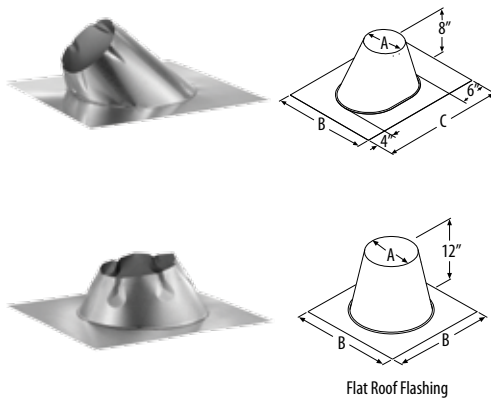

Use to weather proof the penetration of chimney pipe through the roof. Storm Collar required. Select roof flashing based on pitch of roof. For example, a 6/12 pitch has a vertical rise of 6" over a horizontal distance of 12". Made of galvalume.

0/12 - 6/12	10"	12"	14"	16"
A	12 1/2"	14 1/2"	16 1/2"	18 1/2"
B	32"	32"	36"	38"
C	30"	34"	34"	36"
ORDER #	10DT-F6	12DT-F6	14DT-F6	16DT-F12
STOCK #	810000312	810000349	810000381	810000413
FLAT ROOF	10"	12"	14"	16"
A	12 1/2"	14 1/2"	16 1/2"	18 1/2"
B	24"	26"	28"	30"
ORDER #	10DT-FF	12DT-FF	14DT-FF	16DT-FF
STOCK #	810000313	810000350	810000382	810000414

Storm Collar

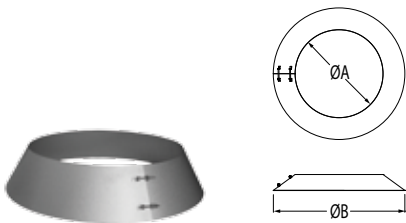

Required with DuraTech flashing to create a weather-proof penetration through the roof deck. Seal inner edge of the collar to the chimney pipe with non-hardening 500°F high-temperature sealant.

SIZE	10"	12"	14"	16"
A	12"	14"	16"	18"
B	23"	25"	27"	29"
ORDER #	10DT-SC	12DT-SC	14DT-SC	16DT-SC
STOCK #	810000311	810000348	810000380	810000412
SIZE	18"	20"	22"	24"
A	20"	22"	24"	26"
B	31"	33"	35"	37"
ORDER #	18DT-SC	20DT-SC	22DT-SC	24DT-SC
STOCK #	810000437	810000461	810000484	810000507

Chimney Cap

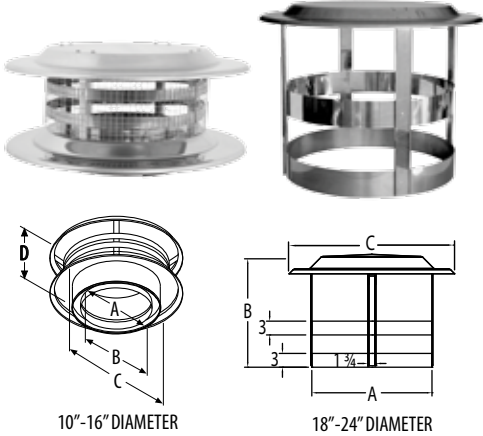

Required where pipe terminates above the roof line. Removable screws allow for cleaning of the chimney and spark arrestor screen. Made of stainless steel.

SIZE	10"	12"	14"	16"
A	10"	12"	14"	16"
B	12"	14"	16"	18"
C	22"	22"	26"	26"
D	10 1/2"	10 1/2"	10 1/2"	10 1/2"
ORDER #	10DT-VC	12DT-VC	14DT-VC	16DT-VC
STOCK #	810000314	810000351	810000383	810000415
SIZE	18"	20"	22"	24"
A	20 1/8"	22 1/8"	24 1/8"	26 1/8"
B	20"	20"	20"	20"
C	30"	32"	34"	36"
ORDER #	18DT-VC	20DT-VC	22DT-VC	24DT-VC
STOCK #	810000438	810000462	810000485	810000508

Economy Chimney Cap

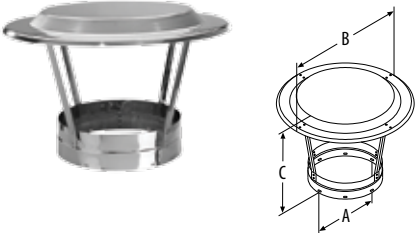

Required where pipe terminates above the roof line. Removable screws allow for cleaning of the chimney and spark arrestor screen. Made of stainless steel. Optional spark arrestor screen available.

SIZE	10"	12"	14"	16"
A	12 1/8"	14 1/8"	16 1/8"	18 1/8"
B	22"	22"	26"	26"
C	13 7/16"	13 3/4"	15 7/16"	15 5/8"
ORDER #	10DT-VCE	12DT-VCE	14DT-VCE	16DT-VCE
STOCK #	810000315	810000352	810000384	810000416

European Copper Adapter - King Model

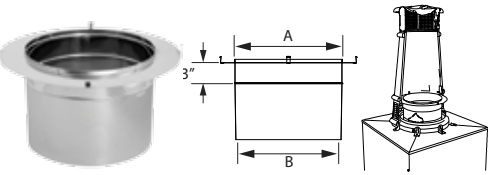

Use for installing the European Copper Chimney Pots King model shroud/pot onto DuraTech chimney.

SIZE	10"	12"	14"
A	10"	12"	14"
B	9 1/2"	11 1/2"	13 1/2"
ORDER #	10DCA-ECK	12DCA-ECK	14DCA-ECK
STOCK #	810000801	810000822	810000843

European Copper Adapter - Bishop Model

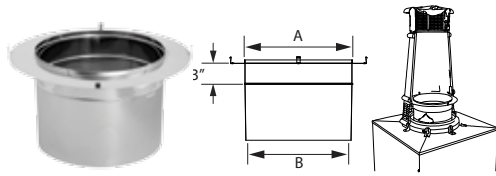

Use for installing the European Copper Chimney Pots Bishop model shroud/pot onto DuraTech chimney. King model shown.

SIZE	10"	12"	14"	16"
A	10"	12"	14"	16"
B	9 1/2"	11 1/2"	13 1/2"	15 1/2"
ORDER #	10DCA-ECB	12DCA-ECB	14DCA-ECB	16DCA-ECB
STOCK #	810000802	810000823	810000844	810000864

Elbow Offset Chart For 5"- 8" DuraTech

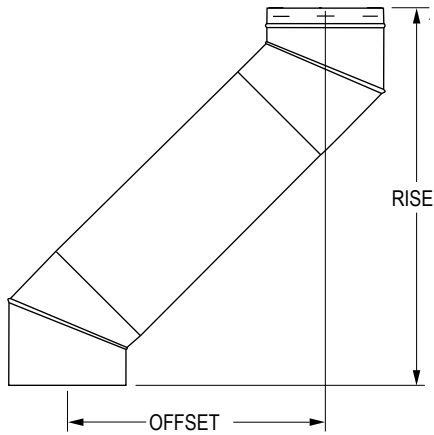

SIZE		5", 6", 7", 8" Diameter	
Elbow Angle from Vertical	Chimney Length Between Elbows	Offset inches	Rise inches
15°	0"	2"	16 1/2"
15°	6"	3 1/4"	21 1/4"
15°	9"	4"	24 1/8"
15°	12"	4 3/4"	27"
15°	18"	6 1/4"	32 3/4"
15°	24"	8"	38 1/2"
15°	36"	11"	50 1/4"
15°	48"	14 1/4"	61 3/4"
15°	48" + 6"	15 1/2"	66 1/2"
15°	48" + 9"	16 1/4"	69 3/8"
15°	48" + 12"	17"	72 1/4"
15°	48" + 18"	18 1/2"	78"
15°	48" + 24"	20"	83 3/4"
30°	0"	4"	15 3/4"
30°	6"	6 1/4"	20"
30°	9"	7 3/4"	22 3/8"
30°	12"	9 1/4"	25 1/4"
30°	18"	12 1/4"	30 1/4"
30°	24"	15 1/4"	35 1/2"
30°	36"	21 1/4"	46"
30°	48"	27 1/4"	56 1/4"
30°	48" + 6"	29 3/4"	60 1/2"
30°	48" + 9"	31 1/4"	63 1/8"
30°	48" + 12"	32 3/4"	65 3/4"
30°	48" + 18"	35 3/4"	71"
30°	48" + 24"	38 3/4"	76"

Large Diameter Elbow Offset Chart For 10"- 16" DuraTech

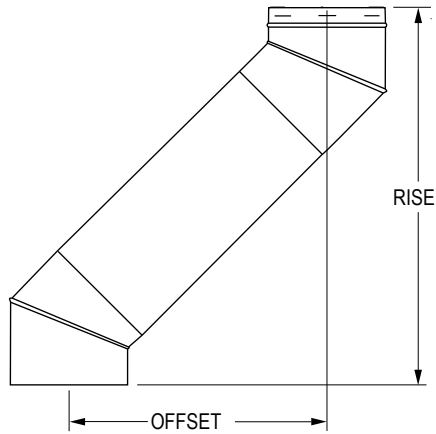

SIZE		10", 12", 14", 16" Diameter	
Elbow Angle from Vertical	Chimney Length Between Elbows	Offset inches	Rise inches
15°	0"	2 3/4"	22 1/4"
15°	6"	4 1/4"	27 1/4"
15°	12"	5 3/4"	33 1/4"
15°	18"	7 1/4"	39"
15°	24"	9"	44 3/4"
15°	36"	12"	56 1/4"
15°	24"+24"	14 3/4"	66 3/4"
30°	0"	6 1/4"	23 3/4"
30°	6"	8 3/4"	27 3/4"
30°	12"	11 3/4"	33"
30°	18"	14 3/4"	38 1/4"
30°	24"	17 3/4"	43 1/4"
30°	36"	23 3/4"	53 3/4"
30°	24"+24"	29"	63"

Large Diameter Elbow Offset Chart For 18"- 24" DuraTech

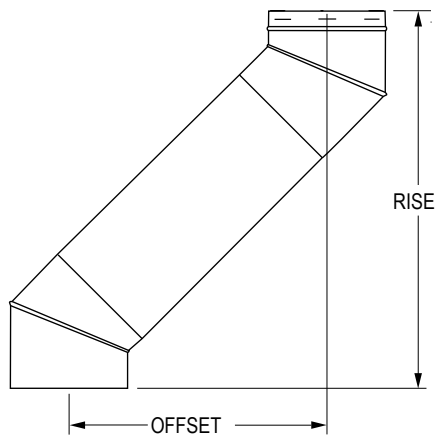

SIZE		18", 20", 22", 24" Diameter	
Elbow Angle from Vertical	Chimney Length Between Elbows	Offset inches	Rise inches
15°	0"	4 1/2"	34 1/2"
15°	12"	7 1/4"	45"
15°	18"	8 3/4"	50 3/4"
15°	24"	10 1/4"	56 1/2"
15°	36"	13 1/2"	68 1/4"
15°	24"+24"	16 1/4"	78 3/4"
30°	0"	8 1/2"	32 3/4"
30°	12"	14"	42 1/4"
30°	18"	17"	47 1/2"
30°	24"	20"	52 3/4"
30°	36"	26"	63"
30°	24"+24"	31 1/2"	72 1/2"

Chimney Sizing Chart For Fireplace Installations

