

PRODUCT SPECIFICATIONS

Elkay Quartz Luxe® 35-7/8" x 21-9/16" x 9" Single Bowl 10" Apron Farmhouse Workstation Sink with Perfect Drain. Proprietary manufacturing process that combines natural quartz with high performance UV-stable acrylic resins results in an impact resistant, nonporous and heat-, scratch-, stain- and fade-resistant surface. Naturally sound deadening and Rear Center drain placement.



| | |
|------------------------------|--|
| Installation Type: | Farmhouse, Sink Kits |
| Material: | Quartz |
| Special Features: | Perfect Drain |
| Finish: | Caviar (CA), Charcoal (CH), Chestnut (CN), Jubilee (JB), Maraschino (MA), Mint Creme (MT), Parchment (PA), Ricotta (RT), Silvermist (SM) |
| Number of Bowls: | 1 |
| Sink Dimensions: | 35-7/8" x 21-9/16" x 10" |
| Bowl 1 Dimensions: | 32-5/8" x 15-3/4" x 8-1" |
| Drain Size: | 3-5/8" (92mm) |
| Drain Location: | Rear Center |
| Minimum Cabinet Size: | 36" |
| Mounting Hardware: | Part # 54300408 included |
| Template Included: | No |

Included with Product: LKCB1812HW cutting board, LKPDQ1CR drain, LKPDQS drain, LKPDQD1 drain, LKCLKIT maintenance kit.

AMERICAN PRIDE. A LIFETIME TRADITION. Like your family, the Elkay family has values and traditions that endure. For almost a century, Elkay has been a family-owned and operated company, providing thousands of jobs that support our families and communities.

Product Compliance: CSA B45.5/IAPMO Z124
Accessory: ASME A112.18.2/CSA B125.2

Perfect Drain: Seamlessly molded collar eliminates the gap between a traditional drain and the sink for a sanitary and gap free installation. Select garbage disposers can be installed on either sink bowl for user convenience. Please see our Garbage Disposer Compatibility Guide.
Patent Pending



Sinks are listed by IAPMO® as meeting the applicable requirements of the Uniform Plumbing Code®, International Plumbing Code®, and National Plumbing Code of Canada.

[Clean and Care Manual \(PDF\)](#)
[Installation Instructions \(PDF\) - 1000005326](#)
[Installation Instructions \(PDF\) - 1000003889_perfect-drain](#)
[Warranty \(PDF\)](#)

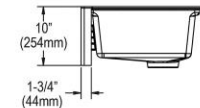
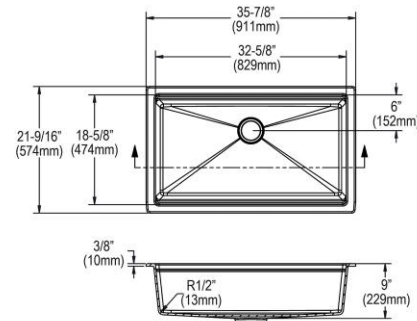

PART: _____ QTY: _____
PROJECT: _____
CONTACT: _____
DATE: _____
NOTES: _____
APPROVAL: _____

In keeping with our policy of continuing product improvement, Elkay reserves the right to change product specifications without notice. Please visit elkay.com for the most current version of Elkay product specification sheets. This specification describes an Elkay product with design, quality, and functional benefits to the user. When making a comparison of other producers' offerings, be certain these features are not overlooked.

in sink erator

Elkay[®] Perfect Drain[™] sinks are designed and approved for compatible disposers manufactured by InSinkErator[®] utilizing the Quick Lock[®] mounting configuration. Use of non-approved disposers may void Elkay warranty.

InSinkErator, Quick Lock and the mounting collar configuration are trademarks of Emerson Electric Co.

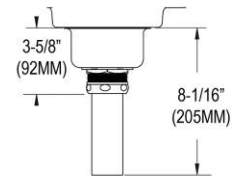



Sink with Drain Kit Installed

Installation Profile:

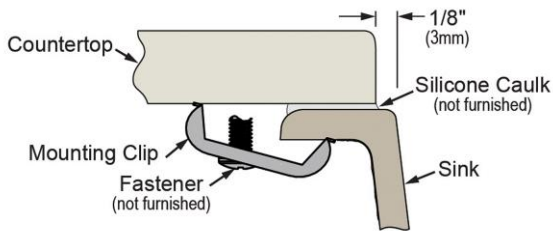
UNDERMOUNT - 1/8" REVEAL

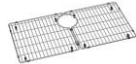

Designed to affix to the underside of any solid surface countertop.

| Optional Accessories | | |
|-----------------------------|--|---|
| LKOBG3014SS | Elkay Stainless Steel 14-7/16" x 29-15/16" x 1-1/4" Bottom Grid Spec Sheet (PDF) |  |
| LKPDQ1LS | Elkay Perfect Drain Fitting Type 304 Stainless Steel Body and Strainer Lustrous Steel Spec Sheet (PDF) |  |
| LK6000CR | Elkay Everyday Single Hole Deck Mount Kitchen Faucet with Pull-down Spray Forward Only Lever Handle Chrome Spec Sheet (PDF) |  |

In keeping with our policy of continuing product improvement, Elkay reserves the right to change product specifications without notice. Please visit elkay.com for the most current version of Elkay product specification sheets. This specification describes an Elkay product with design, quality, and functional benefits to the user. When making a comparison of other producers' offerings, be certain these features are not overlooked.