

ALPHA 15-55 HWR-D

Installation and operating instructions



be
think
innovate

GRUNDFOS 

ALPHA 15-55 HWR-D

English (US)

Installation and operating instructions	4
---------------------------------------------------	---

Original installation and operating instructions

Table of contents

1.	Limited warranty	4
2.	General information	4
2.1	Hazard statements	4
2.2	Notes	5
3.	Receiving the product	5
3.1	Inspecting the product	5
3.2	Scope of delivery	5
4.	Installing the product	6
4.1	Location	6
4.2	Tools	6
4.3	Insulating the pump housing	6
4.4	Mechanical installation	6
4.5	Electrical connection	9
5.	Starting up the product	10
5.1	Venting the system	10
5.2	Starting the pump	11
6.	Product introduction	11
6.1	Product description	11
6.2	Accessories	11
6.3	Intended use	12
6.4	Pumped liquids/media	12
6.5	Identification	12
6.6	Approvals for ALPHA 15-55 HWR-D	13
7.	Control functions	14
7.1	Pump display	14
7.2	Temperature sensor LED	14
7.3	Push-button LED	15
7.4	Repeater LED	15
7.5	Pump curve	16
8.	Servicing the product	17
8.1	Maintaining the product	17
9.	Fault finding the product	18
9.1	Fault finding table	18
10.	Technical data	20
10.1	Operating conditions	20
11.	Disposing of the product	20

for any costs of removal, installation, transportation, or any other charges that may arise in connection with a warranty claim. Products which are sold, but not manufactured by Grundfos, are subject to the warranty provided by the manufacturer of said products and not by Grundfos' warranty. Grundfos will not be liable for damage or wear to products caused by abnormal operating conditions, accident, abuse, misuse, unauthorized alteration or repair, or if the product was not installed in accordance with Grundfos' printed installation and operating instructions and accepted codes of good practice. The warranty does not cover normal wear and tear. To obtain service under this warranty, the defective product must be returned to the distributor or dealer of Grundfos' products from which it was purchased together with proof of purchase and installation date, failure date and supporting installation data. Unless otherwise provided, the distributor or dealer will contact Grundfos or an authorized service station for instructions. Any defective product to be returned to Grundfos or a service station must be sent freight prepaid; documentation supporting the warranty claim and/or a Return Material Authorization must be included if so instructed. Grundfos will not be liable for any incidental or consequential damages, losses, or expenses arising from installation, use, or any other causes. There are no express or implied warranties, including merchantability or fitness for a particular purpose, which extend beyond those warranties described or referred to above. Some jurisdictions do not allow the exclusion or limitation of incidental or consequential damages and some jurisdictions do not allow limitations on how long implied warranties may last. Therefore, the above limitations or exclusions may not apply to you. This warranty gives you specific legal rights and you may also have other rights which vary from jurisdiction to jurisdiction. Products which are repaired or replaced by Grundfos or authorized service center under the provisions of these limited warranty terms will continue to be covered by Grundfos warranty only through the remainder of the original warranty period set forth by the original purchase date.

2. General information

2.1 Hazard statements

The symbols and hazard statements below may appear in Grundfos installation and operating instructions, safety instructions and service instructions.

1. Limited warranty

Products manufactured by Grundfos Pumps Corporation (Grundfos) are warranted to the original user only to be free of defects in material and workmanship for a period of 36 months from the date code listed on the nameplate of the pump. Grundfos' liability under this warranty shall be limited to repairing or replacing at Grundfos' option, without charge, F.O.B. Grundfos' factory or authorized service station, any product of Grundfos manufacture. Grundfos will not be liable



DANGER

Indicates a hazardous situation which, if not avoided, will result in death or serious personal injury.



WARNING

Indicates a hazardous situation which, if not avoided, could result in death or serious personal injury.



CAUTION

Indicates a hazardous situation which, if not avoided, could result in minor or moderate personal injury.

The hazard statements are structured in the following way:



SIGNAL WORD

Description of the hazard

Consequence of ignoring the warning

- Action to avoid the hazard.

2.2 Notes

The symbols and notes below may appear in Grundfos installation and operating instructions, safety instructions and service instructions.



Observe these instructions for explosion-proof products.



A blue or gray circle with a white graphical symbol indicates that an action must be taken.



A red or gray circle with a diagonal bar, possibly with a black graphical symbol, indicates that an action must not be taken or must be stopped.



If these instructions are not observed, it may result in malfunction or damage to the equipment.



Tips and advice that make the work easier.

3. Receiving the product

3.1 Inspecting the product

- Check that the product received is in accordance with the order.
- Check that the voltage and frequency stated on the product nameplate match the voltage and frequency of the installation site.



Take care when handling the product. Do not drop the product.

3.2 Scope of delivery

The box contains the following items:

Quantity	Description
1	ALPHA HWR-D pump
1	Line cord
2	Gaskets
1	Push-button HWR-D
1	Temperature sensor HWR-D*
1	Check valve
1	"Check valve installed" sticker
1	Installation and operating instructions

* If included in this system.

4. Installing the product

4.1 Location

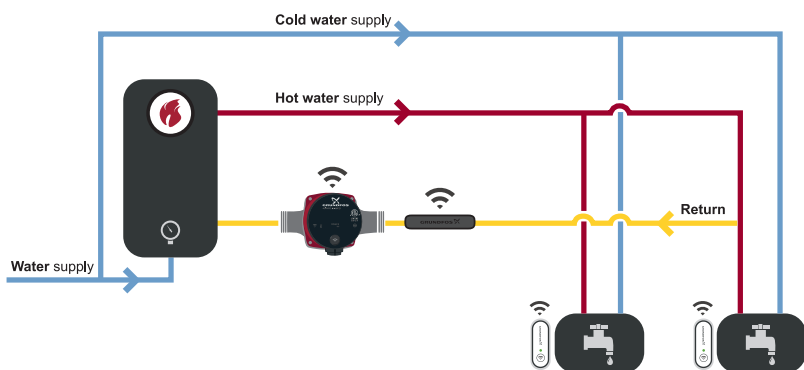

TM073561

Fig. Location of the pump and accessories

The system is intended for indoor use only in areas protected from droplets and splashes.

Maximum ambient temperature is 104 °F (40 °C).

Push-button HWR-D

Do not install the push-button HWR-D in a shower or under the tap/faucet where it could be exposed to water. Mount it at a suitable height out of reach of small children and pets.

Repeater

This repeater is only for use with the ALPHA 15-55 HWR-D system and is intended for indoor installation only in areas safe from droplets and splashes.

For optimum use, place the repeater between the ALPHA 15-55 HWR-D pump and the push-button located furthest away from the pump.

4.2 Tools

You will need the following tools to install the system:

- Hexagon key 4 mm
- Pipe wrench
- Phillips PH1 screwdriver (for temperature sensor screws).

4.3 Insulating the pump housing



Do not insulate the control box. Do not cover the control panel.



TM071424

Fig. Insulating the pump housing

4.4 Mechanical installation

4.4.1 Installing the pump

When making pipe connections, follow the piping manufacturer's recommendations and all code requirements for the piping material.

WARNING

Pressurized system

Death or serious personal injury

- Do not hold the pump in place with tools while tightening the nuts on the pump housing.



1. Flush the system of debris before installation.
2. Insert the check valve if required.

3. Refer to the arrows on the pump housing indicating the direction of the liquid flow through the pump.
4. Install the pump with horizontal motor shaft.
5. Fit the two gaskets supplied to the pump ends.



Remember to use the two gaskets included with the pump.

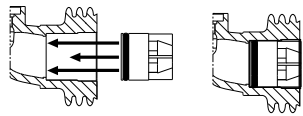

Fig. Check valve installation

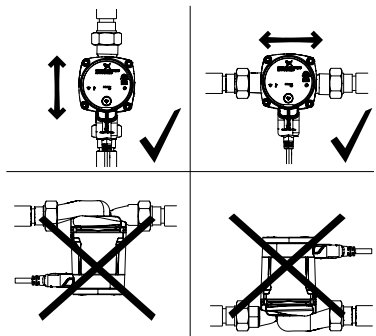

Fig. Installation positions

4.4.2 Changing the power head position

CAUTION



Hot surface

- Minor or moderate personal injury
- Position the pump so that persons cannot accidentally come into contact with hot surfaces.

WARNING



Electric shock

- Death or serious personal injury
- Switch off the power supply before starting any work on the product. Make sure that the power supply cannot be accidentally switched on.

WARNING

Pressurized system

- Death or serious personal injury
- Before dismantling the pump, drain the system or close the isolating valve on either side of the pump before you remove the screws. The pumped liquid may be scalding hot and under high pressure.



If you change the position of the power head, fill the system with the liquid to be pumped or open the isolating valves.

- Make any change to the power head orientation before filling the system with liquid.
- You can turn the power head in steps of 90°. See figure for permissible positions.
- Only use orientations C and D for CSA, enclosure type 2.

Proceed as follows:

1. If liquid is present, drain the liquid from the pump or isolate the liquid from the pump.
2. Remove the four socket head cap screws.
3. Turn the pump head to the desired position.
4. Cross-tighten the screws to: 7 ft-lbs torque.

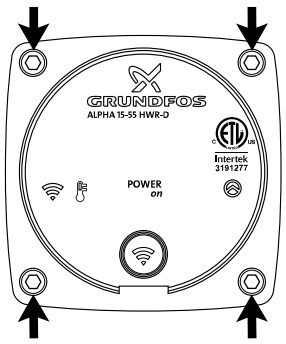

Fig. Removing the four socket head cap screws on the power head

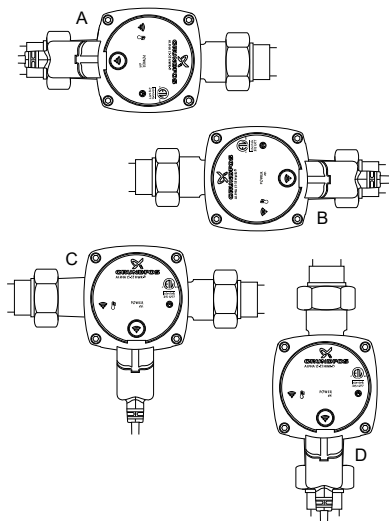

Fig. Power head positions

4.4.3 Installing the temperature sensor

To fulfill the "California water heater regulations 2017 - Title 24", install a temperature sensor HWR-D in proximity to the pump. If the system is to be operated without the temperature sensor, skip this installation step.



Use thermal compound (heat-conducting grease) between the temperature sensor and the pipe system. Thermal compound is not included.

Use only one temperature sensor per system. Follow these steps to install the temperature sensor:

1. Remove the lid of the temperature sensor case.
2. Remove the pull-tab from the end of the AA lithium battery in the sensor case. The temperature sensor will start up.
3. Mount the temperature sensor on a straight section of pipe. Position the temperature sensor to have the best possible contact with the pipe surface. Apply thermal compound (heat-conducting grease) to the back of the sensor case as shown in the figure below. Loosely position the pipe clamp strip around the end of the temperature sensor.
4. Tighten the pipe clamp strip. Keep the clamp on the opposite side of the pipe from the temperature sensor.
 - a. To pair the pump and the temperature sensor: Press and hold the connect button on the pump for 2 seconds. The blue connect symbol on the pump will flash.

Then press and hold the connect button on the temperature sensor for more than 2 seconds. The temperature sensor's internal blue LED will flash. After successful pairing of the pump and the temperature sensor, the blue light will be on continuously for 5 seconds on both devices. If the pairing fails, the connect symbol will flash red for 5 seconds on the pump. If pairing fails, retry the pairing procedure.

5. Replace the lid of the temperature sensor case.
6. Tighten the two end screws on the temperature sensor case. For best performance, fully tighten the screws but do not overtighten.



Fig. Removing the screws from the lid

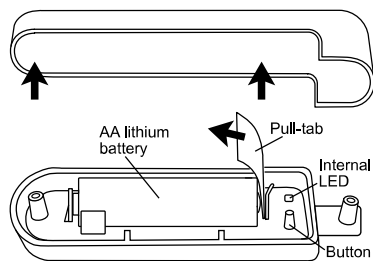

Fig. Removing the lid and the pull-tab



Fig. Apply a small area of thermal compound to the back of the sensor case where shown

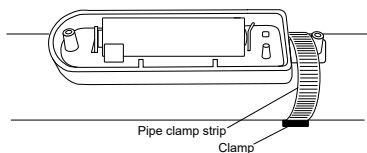
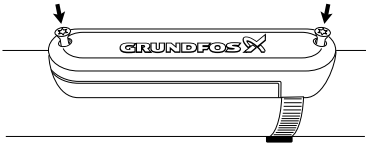

Fig. Positioning the clamp



TM07186

Fig. Replacing the lid and and the screws

4.4.4 Installing the push-button



Do not install the push-button in a shower or under the tap/faucet where it could be exposed to water. Mount it at a suitable height out of reach of small children and pets.

To install the push-button:

1. Remove the mounting bracket from the back of the push-button.
2. Remove the pull-tab from the end of the AAA batteries. The push-button will start up.
3. Use the included double-sided tape to fasten the mounting bracket to a surface or wall away from water droplets or splashes.
4. To pair the push-button with the pump: With the push-button near the pump, press and hold the connect button on the pump for 2 seconds. The blue connect symbol will flash. The connect symbol will stop flashing after 30 seconds if no device has been detected.
5. Press the button on the push-button for 2 seconds. The blue LED on the push-button will flash.
6. After successful pairing of the push-button and the pump, the blue light will be on continuously for 5 seconds on both devices.
7. If the pairing fails, the light will flash red for 5 seconds on both the pump and the push-button. Restart installation of the push-button.
8. To verify operation press button on the push-button for less than 2 seconds. Check that the connect symbol on the pump is on and green for approx. 2 seconds and the pump turns on.
9. Replace the push-button on the mounting bracket.
10. If more than one push-button is used for the system, repeat the installation procedure.

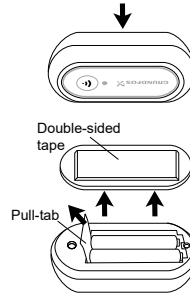

TM07186

Fig. Removing the mounting bracket and the pull-tab

4.4.5 Installing the repeater

To install the repeater:

1. Connect the included USB cable to the repeater.
2. Connect the other end of the USB cable to the included power adapter.
3. Fit the included plug adapter to the power adapter.
4. Plug the power adapter into a power outlet to power on the repeater.
5. The LED on the repeater will light green to indicate the repeater is in operation.

4.5 Electrical connection

DANGER

Electric shock

Death or serious personal injury

- All electrical work must be carried out by a qualified electrician in accordance with the latest edition of the National Electric Code and state, local codes and regulations.



DANGER

Electric shock

Death or serious personal injury

- Switch off the power supply before starting any work on the product. Make sure that the power supply cannot be switched on accidentally.



DANGER

Electric shock

Death or serious personal injury

- This pump has not been investigated for use in swimming pool or marine areas.



DANGER

Electric shock

- Death or serious personal injury
- This pump is supplied with a grounding conductor and grounding-type attachment plug. To reduce the risk of electric shock, be certain that it is connected only to a properly grounded, grounding-type receptacle in accordance with the National Electric Code and any state, local governing codes and regulations.



DANGER

Electric shock

- Death or serious personal injury
- If national, state or local legislation requires a GFCI (Ground Fault Circuit Interrupter) or equivalent in the electrical installation, this shall be type A or better, due to the nature of pulsating DC leakage current.



A Type-A GFCI is identified by this symbol:



The motor is protected by the electronics in the control box and requires no external motor protection.

- Check that the supply voltage and frequency of the installation site correspond to the values stated on the pump.
- Only connect the pump to the power supply with the line cord supplied with the pump.
- Do not modify and only use the line cord supplied.
- The "Power ON" symbol indicates that the electrical supply has been switched on.

4.5.1 Connecting the line cord

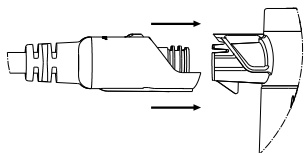

Fig. Inserting the line cord plug into the pump (side view)

To connect the line cord with the pump:

1. Align the line cord plug with the pump.
2. Insert the line cord plug into the pump as shown.
3. Push the line cord plug into the pump.

4.5.2 Removing the line cord

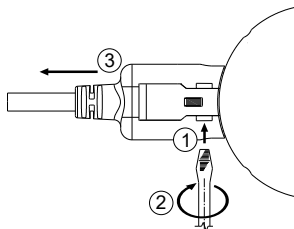

Fig. Removing the line cord plug from the pump (bottom view)

To remove the line cord from the pump:

1. Insert a 1/8 inch flat blade screwdriver into the slot.
2. Twist the screwdriver.
3. Pull the cord to remove it.

5. Starting up the product

5.1 Venting the system

WARNING

Hot water

- Death or serious personal injury
- If the hot water temperature is too high, it can cause severe burns or scalding.
 - To prevent burns or scalding, be sure to limit the temperature of the hot water source before you vent the system.



To vent the system:

1. Turn on the water supply to the hot water source.
2. Verify that there are no leaks in any of the connections.
3. Turn on the tap/faucet furthest from the hot water source until there is a steady stream of water with no evidence of air in the system.

5.2 Starting the pump

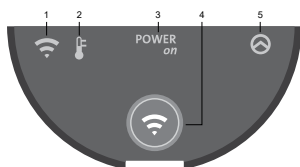

Fig. "Power ON" LED and other indicators on the pump display

Pos.	Description
1	"Connect" LED
2	"Temperature sensor" LED
3	"Power ON" LED
4	Pairing button
5	"Pump operation" LED

- Connect the line cord to the power supply to start the pump.
- The pump will run for approx. 5 seconds and then stop.
- The green "Power ON" LED on the pump display will be lit when the power is on.

6. Product introduction

6.1 Product description



Fig. ALPHA 15-55 HWR-D pump, push-button, and temperature sensor

The ALPHA HWR-D system is an on-demand hot-water recirculation system for use in domestic hot-water applications. It provides optimal comfort by providing hot water instantly on demand.

6.2 Accessories



Fig. HWR-D accessories

Pos.	Description
1	Temperature sensor HWR-D One temperature sensor is either included or may be purchased as an accessory.
2	Push-button HWR-D One push-button is included in the delivery. Additional push-buttons may be purchased as accessories.
3	Repeater HWR-D A repeater is not included but may be purchased as an accessory to increase the range of communication between the push-button and the pump.

6.3 Intended use

The ALPHA 15-55 HWR-D system is intended for domestic hot-water recirculation. When you activate the system with the HWR-D push-button, the pump starts circulating hot water.

To prevent continuous operation, the pump stops recirculating water again when:

a) the media temperature measured at the temperature sensor has increased by 10 °F or is higher than 102 °F.

or

b) the pump has been operating continuously for more than 5 minutes, or for a total of 15 minutes during the last hour.

If the system is operated without the temperature sensor, the pump will stop according to b).

6.4 Pumped liquids/media



CAUTION

Chemical hazard

- Minor or moderate personal injury
- Do not use the pump for flammable liquids, such as diesel or gasoline.



WARNING

Biological hazard

- Death or serious personal injury
- In domestic hot-water systems, the temperature of the pumped liquid must always be above 122 °F (50 °C) due to the risk of legionella.



WARNING

Biological hazard

- Death or serious personal injury
- In domestic hot-water systems, the pump is permanently connected to the main water supply. Therefore, do not connect the pump by a hose.



WARNING

Hot water

- Death or serious personal injury
- If the hot water temperature is too high, it can cause severe burns or scalding.
- Ensure that the temperature of the hot water source is not high enough to cause burns or scalding.



CAUTION

Corrosive substance

- Minor or moderate personal injury
- Do not use the pump for aggressive liquids such as acids or seawater.

The pump is suited for domestic hot water.

Maximum: 14 °dH

Maximum: 149 °F (65 °C)

Maximum peak: 158 °F (70 °C).

For water with a higher degree of hardness, contact Grundfos.

6.5 Identification

6.5.1 Nameplate for ALPHA 15-55 HWR-D

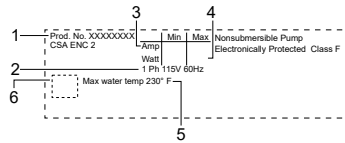

Fig. Nameplate

Pos.	Description
1	Product number
2	Voltage [V]
3	Rated current [A]:
	Min.: Minimum current [A]
	Max.: Maximum current [A]
4	Input power [W]
	Min.: Minimum power [W]
	Max.: Maximum power [W]
5	Maximum liquid temperature [°F]
6	FCC and IC ID

6.6 Approvals for ALPHA 15-55 HWR-D

Approval marks



FCC sections

Section 15.19 (a) 3

This device complies with Part 15 of the FCC Rules. Operation is subject to the following two conditions: (1) this device may not cause harmful interference, and (2) this device must accept any interference received, including interference that may cause undesired operation.

Section 15.21

Any changes or modifications to this equipment not expressly approved by the party responsible for compliance could void the user's authority to operate this equipment.

Section 15.105 (b)



This equipment has been tested and found to comply with the limits for a class B digital device, pursuant to Part 15 of the FCC Rules.

These limits are designed to provide reasonable protection against harmful interference in a residential installation. This equipment generates, uses and can radiate radio frequency energy and, if not installed and used in accordance with the instructions, may cause harmful interference to radio communications. However, there is no guarantee that interference will not occur in a particular installation. If this equipment does cause harmful interference to radio or television reception, which can be determined by turning the equipment off and on, the user is encouraged to try to correct the interference by one or more of the following measures:

- Reorient or relocate the receiving antenna.
- Increase the separation between the equipment and receiver.
- Connect the equipment to an outlet on a circuit different from that to which the receiver is connected.
- Consult the dealer or an experienced radio/TV technician for help.

This equipment complies with FCC/IC radiation exposure limits set forth for an uncontrolled environment and meets the FCC radio frequency (RF) Exposure Guidelines and RSS-102 of the IC radio frequency (RF) Exposure rules. This

equipment should be installed and operated keeping the radiator at least 8 in (20 cm) or more away from person's body.

Cet équipement est conforme aux limites d'exposition au rayonnement définies par la norme FCC / IC pour un environnement non contrôlé et est conforme aux directives d'exposition de la FCC en matière de radiofréquences et la norme RSS-102, des règles d'exposition aux radiofréquences (RF) de l'IC. Cet équipement doit être installé et utilisé en maintenant le radiateur à au moins 8 in (20 cm) du corps de la personne.

Canadian ISED information

These devices (ALPHA 15-55 HWR-D, Push-button HWR-D, Temperature sensor HWR-D and Repeater HWR-D) contain license-exempt transmitter(s)/receiver(s) that comply with Innovation, Science and Economic Development Canada's license-exempt RSS(s). Operation is subject to the following two conditions: 1. This device may not cause interference. 2. This device must accept any interference, including interference that may cause undesired operation of the device. Innovation, Science and Economic Development Canada ICES-003 Compliance Label: CAN ICES-3(B)/NMB-3(B).

L'émetteur/récepteur exempt de licence contenu dans le présent appareil est conforme aux CNR d'Innovation, Sciences et Développement économique Canada applicables aux appareils radio exempts de licence. L'exploitation est autorisée aux deux conditions suivantes : 1. L'appareil ne doit pas produire de brouillage; 2. L'appareil doit accepter tout brouillage radioélectrique subi, même si le brouillage est susceptible d'en compromettre le fonctionnement. Étiquette de conformité à la NMB-003 d'Innovation, Sciences et Développement économique Canada : CAN ICES-3(B)-3(B).

These devices (ALPHA 15-55 HWR-D, Push-button HWR-D, Temperature sensor HWR-D and Repeater HWR-D) comply with Industry Canada RSS-247 and license-exempt RSS standard(s). Operation is subject to the following two conditions: (1) this device may not cause interference, and (2) this device must accept any interference, including interference that may cause undesired operation of the device.

Ce dispositif est conforme à la norme CNR-247 d'Industrie Canada applicable aux appareils radio exempts de licence. Son fonctionnement est sujet aux deux conditions suivantes: (1) le dispositif ne doit pas produire de brouillage préjudiciable, et (2) ce dispositif doit accepter tout brouillage reçu, y compris un brouillage susceptible de provoquer un fonctionnement indésirable.

7. Control functions

7.1 Pump display

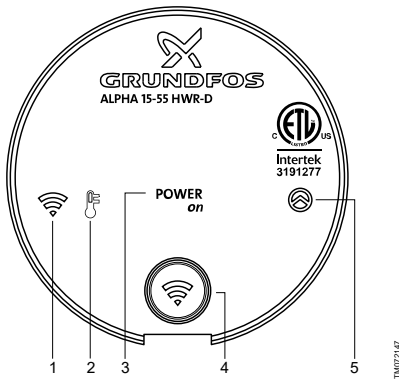

Fig. LED symbols and buttons on the pump display

Pos.	Description
1	"Connect" LED
2	"Temperature sensor" LED
3	"Power ON" LED
4	Pairing button
5	"Pump operation" LED

Pump display symbol	Status	Explanation
"Power ON"	Green	Lights green when pump is powered on.
"Connect"	Flashing blue	Flashes blue when the pump is ready for pairing with the push-button or temperature sensor. The symbol flashes blue when a paired temperature sensor has been disconnected.
"Connect"	Blue	Lights blue for 5 seconds when pairing is successful between the pump and the push-button or temperature sensor.
"Connect"	Flashing red (5 seconds) during installation	Flashes red for 5 seconds, when pairing has failed with

Pump display symbol	Status	Explanation
"Connect"	Flashing red (2 seconds) during normal operation	the push-button or temperature sensor. Flashes red for 2 seconds when the battery level in the push-button is at a critical level. Replacement of the batteries in the push-button is recommended.
"Connect"	Green	Lights green for 2 seconds when the push-button is activated during normal operation.
"Pump operation"	Green	Lights green when the pump circulates water during normal operation and is connected to the temperature sensor.
"Pump operation"	Yellow	Lights yellow when the pump has timed out. The pump does not circulate water.
"Pump operation"	Red	The pump is in an alarm state (see fault finding section).
"Temperature"	Red	Lights red when the battery level in the temperature sensor is at a critically low level (see fault finding section). Replace the battery in the temperature sensor.

7.2 Temperature sensor LED

The LED is located on the temperature sensor beneath the lid. You must remove the lid in order to pair the temperature sensor with the pump.

Status	Explanation
Flashing blue	The LED flashes blue when the temperature sensor is ready for pairing with the pump.
Blue	The LED lights blue for 5 seconds when pairing between the temperature sensor and the pump has succeeded.

Status	Explanation
Flashing red (5 seconds) during installation	The LED flashes red for 5 seconds when pairing between the temperature sensor and the pump has failed. Restart of the installation procedure is recommended.

7.3 Push-button LED

LED status	Explanation
Flashing blue	The LED flashes blue when the push-button is ready for pairing with the pump.
Blue	The LED lights blue for 5 seconds when pairing between the push-button and the pump has succeeded.
Flashing red (5 seconds) during installation	The LED flashes red for 5 seconds when pairing between the push-button and the pump has failed. Restart of the installation procedure is recommended.
Flashing red (2 seconds) during normal operation	The LED flashes red for 2 seconds when the battery level in the push-button is at a critical level, and the push-button is activated. Replacement of the batteries in the push-button is recommended.
Green	The LED lights green for 2 seconds when the push-button is activated during normal operation.

7.4 Repeater LED

The LED on the repeater will light green when the repeater is in operation.

7.5 Pump curve

The pump runs at a constant speed and consequently on a constant curve. The pump is set on the maximum curve under all operating conditions.

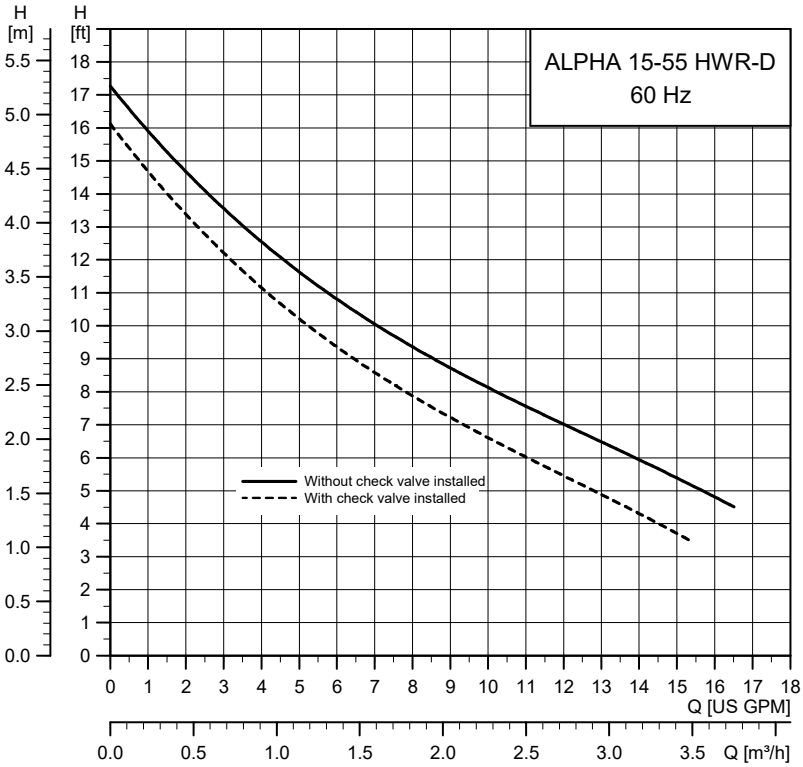

Fig. Performance curve, ALPHA 15-55 HWR-D

TM072501

8. Servicing the product

8.1 Maintaining the product

The ALPHA HWR-D pump is maintenance-free.

If the pump is damaged, for example with fractures or dents, replace the pump.

8.1.1 Battery replacement

WARNING

Biological hazard

- Death or serious personal injury
 - Keep batteries out of reach of small children, the elderly, and pets. Batteries can cause permanent injury if ingested or placed in the nose, mouth, or ears.
 - Immediate emergency room treatment is required for anyone who ingests a battery. In addition, in the US, consult the 24-hour National Battery Ingestion Hotline at 800-498-8666 for assistance.



CAUTION

Corrosive substance

Moderate to minor personal injury and risk of property damage

- The push-button HWR-D or temperature sensor HWR-D must be replaced if battery leakage occurs.



CAUTION

Flammable material

Minor or moderate personal injury

- Do not attempt to recharge non-rechargeable batteries.



To clean the push-button or temperature sensor, wipe it with a clean, damp cloth.

Ensure that disposal of old batteries is in accordance with local regulations. Recycle old batteries where possible.

8.1.1.1 Battery replacement for temperature sensor

The temperature sensor uses AA 3.6 V lithium-thionyl batteries. To change the battery in the temperature sensor, follow these steps:

1. Remove the lid of the temperature sensor.
2. Remove the old battery.
3. Insert the new battery.
4. Replace the lid of the temperature sensor.

8.1.1.2 Battery replacement for push-button

The push-button uses AAA 1.5 V alkaline batteries. To change the battery in the push-button, follow these steps:

1. Remove the push-button from the mounting bracket on the back of the push-button.
2. Remove the old batteries.
3. Insert the two new batteries.
4. Replace the push-button on the mounting bracket.

9. Fault finding the product

9.1 Fault finding table

Fault: The pump does not start.

Status	Cause	Remedy
"Power On" LED on the pump control panel is not lit.	The pump is not connected to the power supply.	Make sure the power supply is switched on.
		Check if external protection has tripped.
		Make sure the cables and connections are free from defects and connected securely.
The "Power On" LED on the pump control panel is green. The "Pump Operation" LED is red.	The pump is in an alarm state.	Contact your local Grundfos representative.
The "Power On" LED on the pump control panel is green, but the pump does not start when the push-button is activated.	If the "Pump Operation" LED on the pump control panel is yellow, the pump has timed out.	Wait until the yellow "Pump Operation" LED turns off.
	The push-button is not paired with the pump.	Follow the pairing procedure for the push-button.
	The push-button batteries need replacing.	Replace the batteries in the push-button.
After installing the repeater, the "Power On" LED on the pump control panel is green, but the pump does not start when the push-button is activated.	The push-button is out of range.	Use the Repeater HWR-D accessory to increase the range of wireless signals.
	The push-button is out of range, and the pump does not receive the repeater's wireless signal.	Relocate the repeater within the house for optimum range of wireless signals.

Fault: The "Connect" LED is flashing blue continuously.

Status	Cause	Remedy
The "Connect" LED on the pump control panel is flashing blue. The temperature sensor has been disconnected from the pump.	The temperature sensor is out of range.	Ensure the temperature sensor is in proximity to the pump.
	The temperature sensor batteries need replacing.	Replace the batteries in the temperature sensor.
	The temperature sensor is not working.	Replace the temperature sensor. Follow the pairing procedure for the new temperature sensor.

Fault: There is noise in the hydraulic system.

Status	Cause	Remedy
There are no indicators lit on the pump or accessories.	Air in the system.	Open a faucet or tap to let trapped air escape.

Fault: There is noise in the circulator pump.

Status	Cause	Remedy
There are no indicators lit on the pump or accessories.	Air is trapped in the pump.	Open a faucet or tap to let trapped air escape.
	No liquid.	Ensure there is liquid in the hot water supply source.

10. Technical data

10.1 Operating conditions

Supply voltage	
- Pump	1 x 115 V, +10 % / -10 % , 60 Hz
- Repeater with USB plug	5 V DC, +10 % / -10 %
- AC power adapter for repeater	100-240 V AC, +10 % / -10 % , 50/60 Hz
Motor protection	The pump requires no external motor protection.
Enclosure class	Indoor use only, IP42. CSA enclosure type 2.
Insulation class	F.
Relative humidity	Maximum 95 %.
Maximum outlet pressure	150 psi (10.34 bar).
Sound pressure level	43 dB (A).
Ambient temperature	34 to 104 °F (1 to 40 °C)

Inlet pressure

Liquid temp.	Min. inlet pressure
167 °F (75 °C)	0.75 psi (0.05 bar)
194 °F (90 °C)	4.06 psi (0.28 bar)
230 °F (110 °C)	15.7 psi (1.08 bar)

Liquid temperature

36 °F (2 °C) to 230 °F (110 °C)



In domestic hot water systems, keep the liquid temperature below 149 °F (65 °C) to eliminate the risk of lime precipitation.

To avoid condensation in the control box and stator, the liquid temperature must always be higher than the ambient temperature.

Ambient temp.	Min. liquid temp.	Max. liquid temp.
[°F (°C)]	[°F (°C)]	[°F (°C)]
34 (1)	36 (2)	230 (110)
50 (10)	50 (10)	230 (110)
68 (20)	68 (20)	230 (110)
86 (30)	86 (30)	230 (110)
95 (35)	95 (35)	194 (90)
104 (40)	104 (40)	158 (70)

Approximate power usage

Minimum: 2 W

Maximum: 45 W

11. Disposing of the product

CAUTION

Magnetic field

Minor or moderate personal injury



- Persons with pacemakers disassembling this product must exercise care when handling the magnetic materials embedded in the rotor.

This product or parts of it must be disposed of in an environmentally sound way:

1. Use the public or private waste collection service.
2. If this is not possible, contact the nearest Grundfos company or service center.

See also end-of-life information at www.grundfos.com/product-recycling.

U.S.A.

GRUNDFOS Pumps Corporation
9300 Loiret Boulevard
Lenexa, Kansas 66219 USA
Tel.: +1 913 227 3400
Fax: +1 913 227 3500

GRUNDFOS Water Utility Inc.
3905 Enterprise Court
P.O. Box 6620
Aurora, IL 60598-0620
Phone: +1-630-236-5500
Fax: +1-630-236-5511

GRUNDFOS CBS Inc.
902 Koomey Road
Brookshire, TX 77423 USA
Phone: 281-994-2700
Toll Free: 1-800-955-5847
Fax: 1-800-945-4777

Peerless Pump
2005 Dr. Martin Luther King Jr
US-46202 Indianapolis, Indiana U.S.A.
Phone: 317-925-9661

Canada

GRUNDFOS Canada Inc.
2941 Brighton Road
Oakville, Ontario
L6H 6C9
Tel.: +1-905 829 9533
Fax: +1-905 829 9512

Mexico

Bombas GRUNDFOS de México
S.A. de C.V.
Boulevard TLC No. 15
Parque Industrial Stiva Aeropuerto
Apodaca, N.L. 66600
Tel.: +52-81-8144 4000
Fax: +52-81-8144 4010

Revision Info

Last revised on 13-10-2016

99475026 0119

ECM: 1251559
