

Residential Combustion Meter

INSTRUCTION MANUAL

ENGLISH

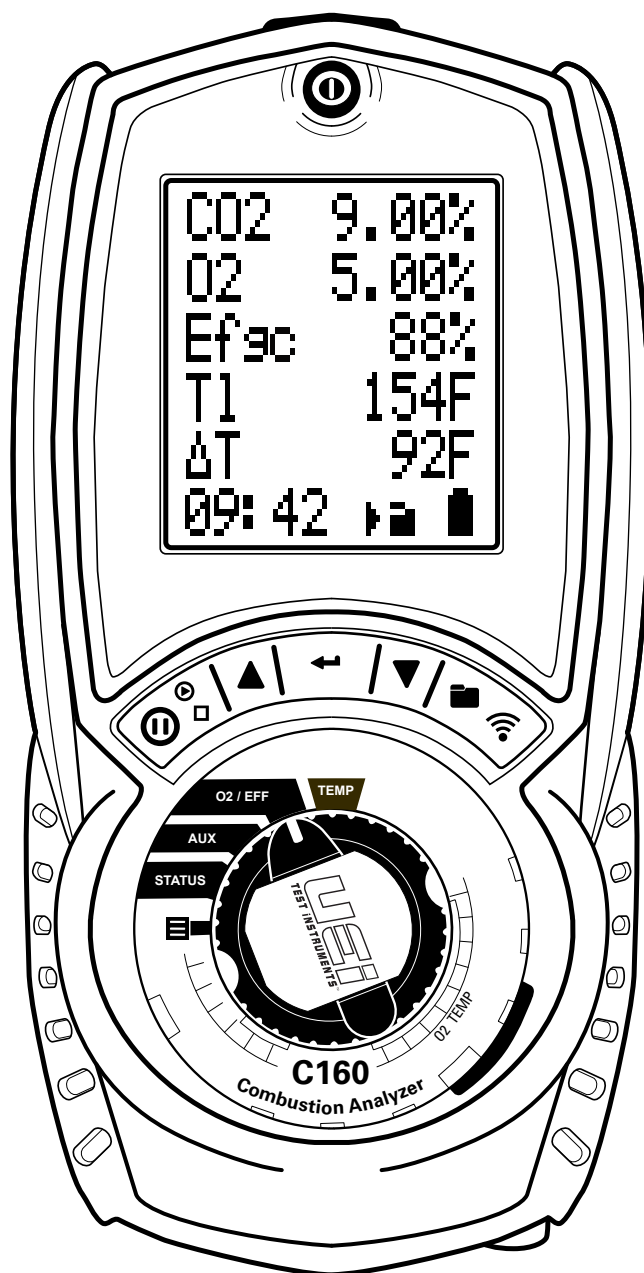

RoHS
Compliant

REACH
Compliant

TABLE OF CONTENTS

<p>Functions 2</p> <p>Features 2</p> <p>General Specifications 3</p> <p>Important Safety Warnings 3</p> <p>Symbols 3</p> <p>Meter Overview 4-5</p> <p>Overview 6</p> <p>Pre Test Checklist 6</p> <p>Setting Inlet Temperature 6</p> <p>Meter Connections 6</p> <p>Emptying & Cleaning the In-Line Water Trap 7</p> <p>Changing The Particle Filter 7</p> <p>Quick Start 7</p> <p>Fresh Air Purge 7</p> <p>Measuring Flue Gases 7</p> <p>Display Parameters 8</p> <p>Status Screen 9</p> <p>Status Bar 10</p> <p style="padding-left: 20px;">Status Bar Icons 10</p> <p style="padding-left: 20px;">Status Bar Icon Layout 10</p> <p style="padding-left: 20px;">Status Bar Menu Options 10</p> <p style="padding-left: 20px;">Status Bar Options Table 10</p> <p>Menu 11</p> <p style="padding-left: 20px;">Using the Menu 11</p> <p style="padding-left: 20px;">Menu Items 11</p> <p>Stored Logs Memory 12</p> <p style="padding-left: 20px;">Menu Options 12</p> <p style="padding-left: 20px;">Viewing Stored Logs 13</p> <p style="padding-left: 20px;">Log View Menu Options 13</p> <p style="padding-left: 20px;">Navigating Stored Logs 13</p> <p style="padding-left: 20px;">Log Navigation Menu Options 14</p>	<p>Printouts 15</p> <p>Specifications 16</p> <p>Certification 16</p> <p>Where to Test 17-18</p> <p>What Results are Generally Acceptable 18</p> <p style="padding-left: 20px;">What Results Are Generally Acceptable 18</p> <p style="padding-left: 20px;">Typical Excess Air Level 18</p> <p>Powering Off 19</p> <p>Post Test 19</p> <p>General Maintenance 19</p> <p>Cold Weather Precautions 19</p> <p>Replacing the Batteries 20</p> <p>Canadian annual recertification services 20</p> <p>USA annual recertification services 21</p> <p>Product Registration 21</p> <p>Other Important Factors Relating to Combustion 22</p> <p>Combustion Measurement Terms 22</p> <p style="padding-left: 20px;">Net Temperature 22</p> <p style="padding-left: 20px;">Draft 22</p> <p style="padding-left: 20px;">Efficiency 22</p> <p style="padding-left: 20px;">Combustion Efficiency Calculations 22</p> <p>Disposal 24</p> <p>Cleaning 24</p> <p>Storage 24</p> <p>Warranty 24</p>
---	--

FUNCTIONS

- **Measures:** Flue temperature, Inlet temperature, O₂
- **Calculates:** CO₂, Efficiency (Net or Gross), Efficiency (High Condensing), Excess Air, Losses

FEATURES

- **Large 6 line display**
- **Water Trap Indication**
- **High Altitude Compensation**

GENERAL SPECIFICATIONS

- **Operating Temperature:** 32° to 113°F (0° to 45°C)
- **Storage Temperature:** 0° to 113°F (-18° to 45°C)
- **Operating Humidity:** 15% to 90% R.H.
- **Back light:** Yes
- **Dimensions:** 8.54 x 4.18 x 1.86 inch
- **Item Weight:** 1.51 lb
- **Calibration:** Recommended Annually
- **Certification:** CE Conformity, RoHS, REACH Compliant, AHRI 1260 standard
- **Battery Type:** NiMH (AA) 3
- **Accuracy:** ± (% of reading + # of least significant digits)

IMPORTANT SAFETY WARNINGS

 Read entire Safety Notes section regarding potential hazard and proper instructions before using this Meter. In this manual the word **“WARNING”** is used to indicate conditions or actions that may pose physical hazards to the user. The word **“CAUTION”** is used to indicate conditions or actions that may damage this instrument. This Meter must only be used in well-ventilated locations by trained and competent persons after due consideration of all potential hazards.

 To ensure safe operation and service of the tester, follow these instructions. Failure to observe these warnings can result in severe injury or death.













- Do not use this meter during electrical storms or in wet weather.
- To avoid false readings, charge batteries if a low battery indicator appears.
- Always adhere to national and local safety codes. Use proper personal protective equipment (PPE).

 This meter extracts combustion gases that may be toxic in relatively low concentrations. These gases are exhausted from the back of the meter.

 This meter is designed for trade professionals who are familiar with the hazards of their trade. Observe all recommended safety procedures that include proper lockout utilization and use of personal protective equipment that includes safety glasses, gloves and flame resistant clothing.

Users of portable gas detectors are recommended to conduct a “bump” check before relying on the unit to verify an atmosphere is free from hazard. A ‘bump’ test is a means of verifying that an instrument is working within acceptable limits by briefly exposing to a known gas mixture formulated to change the output of all the sensors present. This is different from a calibration where the instrument is also exposed to a known gas mixture but is allowed to settle to a steady figure and the reading adjusted to the stated gas concentration of the test gas.

SYMBOLS

	Low battery	°F	Degrees Fahrenheit
°C	Degrees Celsius		Pump Status
	Pump Start		Pump Stop
	Hold		Printing
	Navigate Down		Navigate Up
	Enter Key		Save Log

METER OVERVIEW

A. Infrared Printer Port

B. On/ Off (Power) Button

C. 6 Line Backlit Display

- Press any button to turn Back light on (will turn off after 10 seconds)

D. Protective Rubber Boot With Magnets

E. Status Bar Line

F. Data Hold Button: Short press to hold current data.

G. Pump Toggle Button: Long press to toggle pump on and off

H. UP Button

- Short press to navigate "UP".

I. Save Log Button: Long press to store data.

J. Print Report Button: Short press to print a report to IR Port. (will enter a print option if Wireless Module is fitted)

K. Down Button

- Short press to navigate "DOWN"

L. ENTER Button

- Short press select current option displayed
- Long press to activate some menu items

M. Rotary Dial

N. Particle Filter (inside water trap)

O. Water Trap

P. LED Full Water Trap Indicator

Q. Serial Number: (under Protective Boot)

R. Sensors Fitted: (under Protective Boot) Indicates Sensors fitted in unit

S. Battery Compartment: (under Protective Boot)

T. Grip Indentation: Indentation for fingers to grip meter

U. Water Trap Drain Plug (Red plug; take caution NOT to damage plug when removing protective boot)

V. Battery Charge USB Adapter Connection

W. Temperature Connection

- Flue Probe Temperature: T1 or T2

X. Flue Gas Inlet Connection

METER OVERVIEW (CONT.)

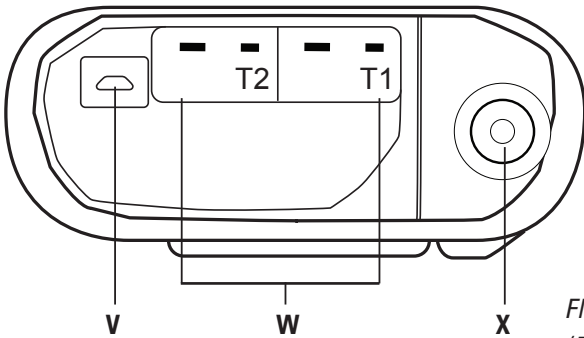
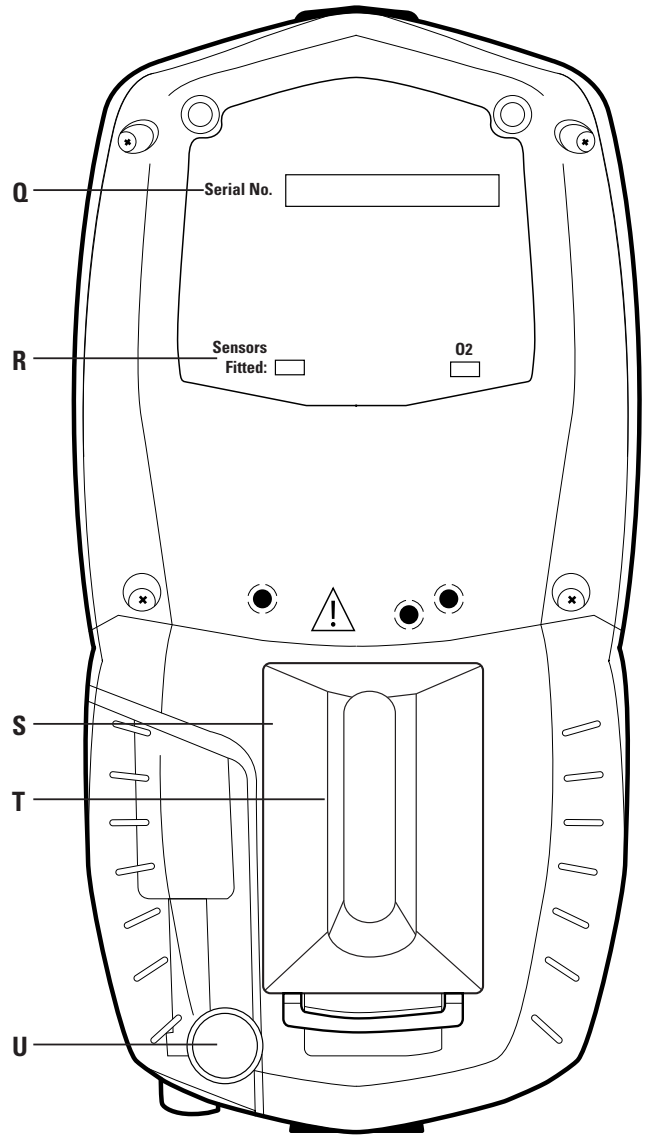
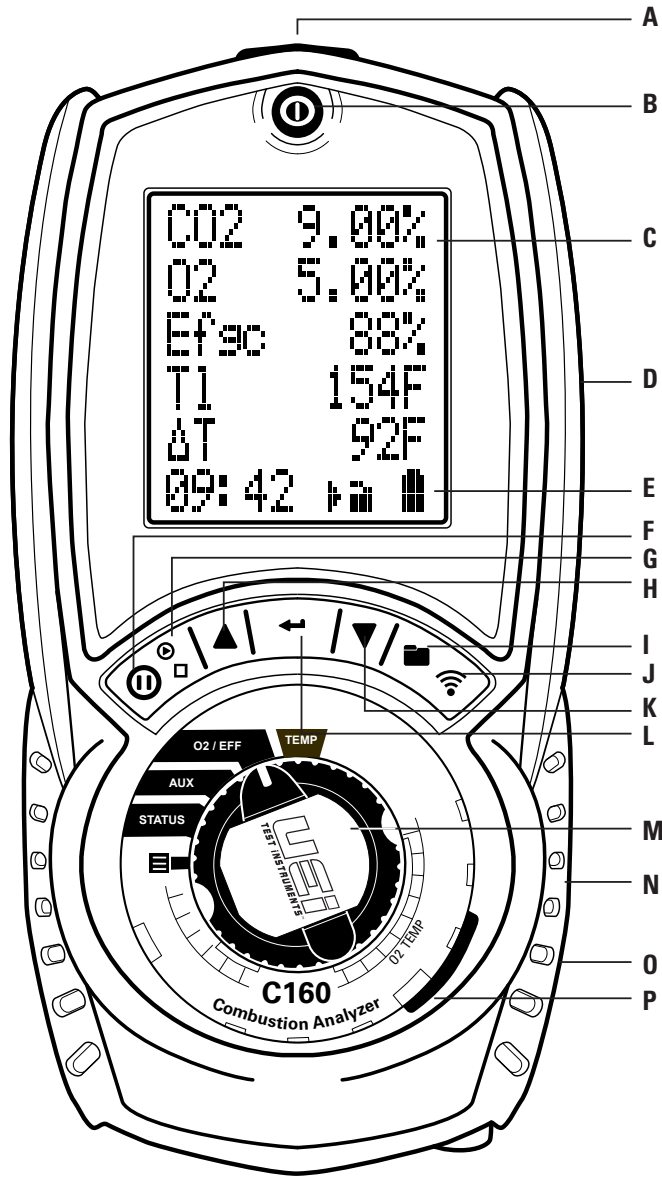

Flue Probe Temperature Plug
(Plugs into T1)

Narrow Pin MUST be on the
Right hand side.

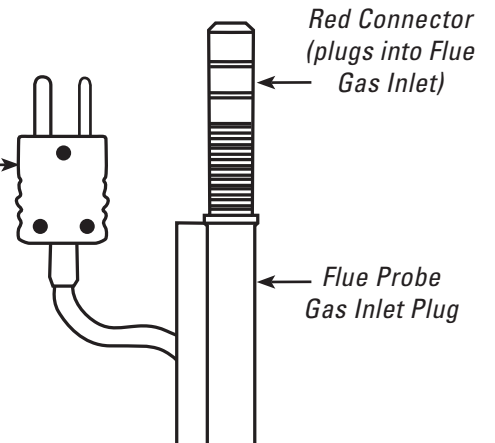

OVERVIEW

CO₂ is set to zero in fresh air automatically after the initial 25 second countdown.

The meter has a protective rubber boot with magnets for hands-free operation.

A large 6 line display provides the user with relevant information based on current activity including instrument status via the new intelligent Status Bar. All data can be printed via an optional infrared printer.

The C160 uses a new data storage system allowing up to 30 logs of any combination of Combustion rather than be restricted to an allowance of particular logs.

10 characters can be added to Line 1 of the header, 6 characters to Line 2 of Header of the printouts.

PRE TEST CHECKLIST

- Clean particle filter
- Water trap and probe line are empty of water
- Power on and zero
- All hose and thermocouple connections are properly secured
- Flue gas probe is sampling ambient FRESH air
- Water trap is fitted correctly to the instrument
- Flue temperature plug is connected
- Ensure water trap plug is inserted correctly

SETTING INLET TEMPERATURE

- Turn on and zero the meter without the flue probe connected to use ambient temperature.
- Connect flue probe thermocouple to T1 during zero countdown use for inlet ducted system.

METER CONNECTIONS



WARNING!

Turning the pump off while the probe is in the flue will leave toxic gases inside the meter. Once data has been printed or copied, it is advisable to purge the unit with fresh air as soon as possible. To do this remove the probe from the flue and turn ON pump.



WARNING!

The probe will be hot from flue gases. Remove the probe from the flue and allow it to cool naturally. Do not immerse the probe in water, as this will be drawn into the meter and damage the pump and sensors.

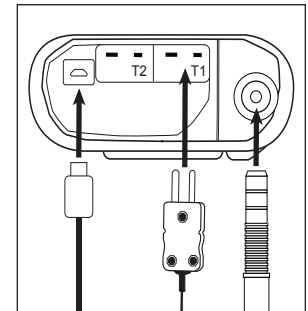

NOTE: Take care when inserting the temperature probes as the pins are polarized. Insert with the smaller pin (+) to the right.

EMPTYING & CLEANING THE IN-LINE WATER TRAP

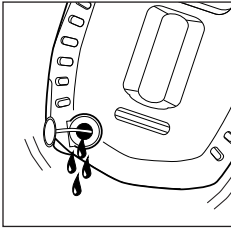

- Remove the rubber plug
- Allow the water to drain out
- Re-insert the rubber plug

CHANGING THE PARTICLE FILTER

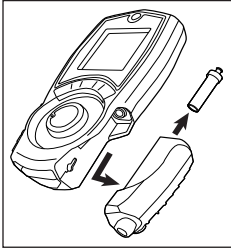

- Remove the protective rubber boot
- Slide the water trap unit from the meter
- Remove the particle filter from its' spigot and replace
- Slide the water trap back into position and replace protective rubber boot

QUICK START

Turn on the meter by pressing the On/Off Button for 2 seconds until the unit activates. As described the meter will perform a 25 second turn on purge. Once completed simply select the reading desired by the position of the rotary dial.

FRESH AIR PURGE

AIR PURGE
REMOVE
FLUE
PROBE

▶ PURGE ◀

Each time the meter is turned on it will perform a 25 second air purge, this is to clear the gas sampling path (including probe, if connected), and self calibrate the CO₂ detection system. For these reasons it is very important that the meter be in **outside fresh air** when powered on.

⚠ WARNING

When in the Rotary Dial positions O₂/Eff; Press the Up or Down Buttons, scroll to CO₂ Zero. On the Purge option, short press the Edit Button, and a 60 second Purge will begin.

MEASURING FLUE GASES

After the initial countdown is finished and the meter is properly setup, put its' flue probe in the appliance's sampling point. The tip of the probe should be at the center of the flue. Use the flue probes depth stop cone to set the position.

With balanced flues, make sure the probe is positioned into the flue so no air can "back flush" into the probe.

NOTE: Ensure the flue probe handle does not get hot!

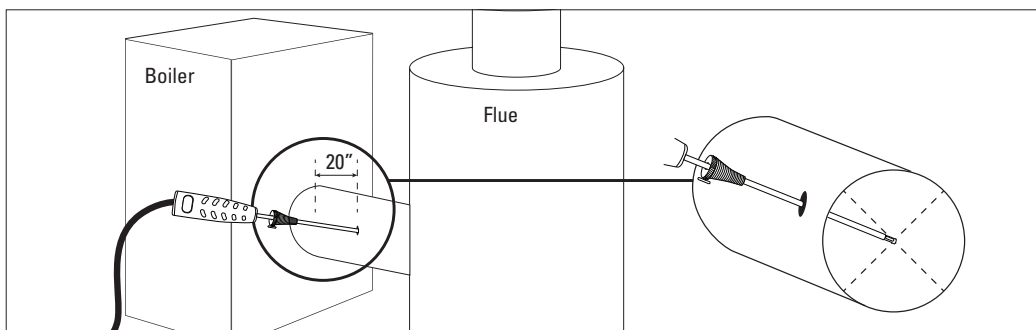

DISPLAY PARAMETERS

The large display is backlit with 6 lines, the last line is the Status Bar line.

Menu Screen

Time (settable parameter; HH:MM:SS, displayed in 24 hour clock format)

Date (settable parameter; MM:DD:YY)

Header (16 character, 2 line settable parameter; 10 characters can be added to Line 1 of the header, 6 characters to Line 2)

IR Print (KMIRP to IRP-3)

°C/°F (Selectable parameter)

Gas Unit (Selectable parameter; select between ppm(n), ppm, mg/kWh(n), mg/kWh, mgm3(n), mgm3)

Language (settable parameter; select between English, Espanol, Francais)

EFF (Efficiency; select between Efgn or Efgc except for Heavy Oil and Pellets)

O2 Ref (Selectable parameter; select between 0.0% to 20.0%)

Logs (if logs are saved, they will be displayed)

Code (for Authorized Service Personnel only)

Status Screen

Ta (Ambient temperature)

CAL (days until next calibration due)

AUX screen

T1

T2

ΔT

O2%

XAIR

STATUS BAR

Screens after Status screen to:

AUX screen

T1

T2

ΔT

O2%

XAIR

STATUS BAR

O2/EFF (Flue 1) screen

O2%

CO2% (calcuated based on the fuel type selected)

T1

ΔT

EFF

STATUS BAR

TEMP screen

T1

T2

ΔT
BLANK
BLANK
STATUS BAR

TEMP screen

T1
T2
ΔT
BLANK
BLANK
STATUS BAR

Purge option

When the Rotary Dial is in O2/Eff; Press the ▲ or ▼ Buttons to scroll to CO₂ Zero. Press and hold ← to select. Press ← to start a 60 second Purge.

STATUS SCREEN

Select "Status" on the dial to view the following:

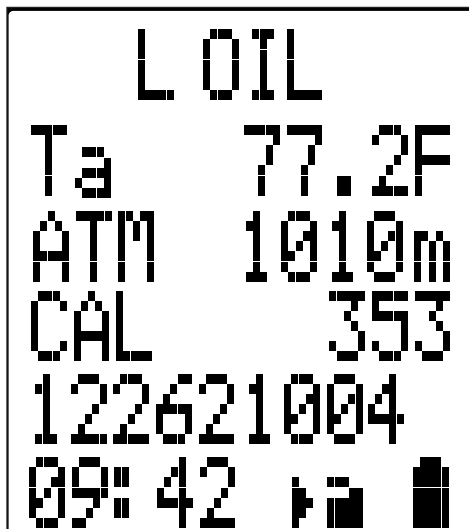

Current fuel selection. Use status bar to change fuel selection.

Select between: Pellets, Light Oil, Heavy Oil, LPG, Butane, Propane, Natural Gas, Bio Oil

Ambient temperature around the meter.

Shows number of days until next calibration is due.

Status Bar.

User Interface

The large six-line display will indicate 5 lines and the status bar (see pg. 9) the backlight will activate on each button press and turn off after 10 seconds of no activity. Navigation through the various start options and menu system is via the 3 button dedicated Up, Down & Enter Buttons. Button presses are categorized short press and long press (in the same manner as many modern consumer electronics).

Status Bar

The Status Bar provides the user with a concise indication of the instrument status, it incorporates an intelligent system that understands what the user is currently viewing on the display offering appropriate menu items as well as standard menu items.





Navigation through the Status Bar options is achieved via the ▲ and ▼ buttons when the Status Bar is visible on the display.

STATUS BAR

Status Bar Icons

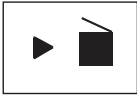
The icons are designed to provide quick and simple instrument status information without having to navigate complicated menu systems or detract from the job at hand.

Status Bar Icon Layout

Pump		<i>Pump on</i>
Pump		<i>Pump paused</i>
Sending Data		<i>Indicates data is being transmitted to either the App or the Printer</i>
Battery		<i>Battery Status indication</i>

Status Bar Menu Options

The Status Bar will offer the user Menu items based on the Selector Dial setting.

Status Bar Options Table

Status Info Available	Test Screen/ Dial Digital Position/ Test Screen	
	STATUS	O2/Eff
TIME	✓	✓
FLUE SELECTED	✓	✓
DATE	✓	✓
CO2 FLUE		✓

Date Option Date (Displayed as)



MENU

Using the Menu

The Menu position on the Rotary Dial allows for the customization of the default settings for the meter as per the user's requirements. Navigation through the Menu system is via the dedicated user's interface buttons (Up, Down, Enter).

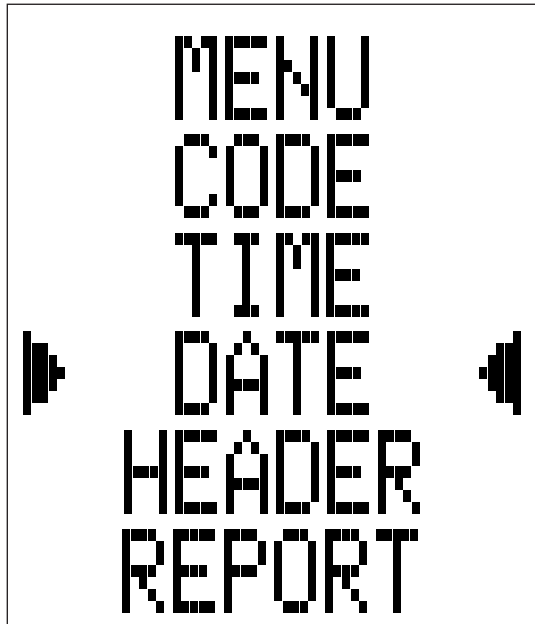

Menu Option to edit

As you navigate up or down through the Menu, the items will scroll accordingly, eventually back to the beginning.

Rotate Selector Dial to **MENU** to set up or customize your settings.

Selected parameter are centered, highlighted with arrow icons on either side.

Use ▲ and ▼ buttons to scroll menu options,

Press ← to a select a parameter to edit. Press ← button to scroll fields to change .

Press ▲ and ▼ buttons to change field contents.

Press ← to enter content selected.

Menu Items

MENU	Sub Menu	OPTIONS/COMMENTS
Time	HH:MM:SS	24 Hour Format (e.g. 7AM= 7:00:00, 7PM = 19:00:00)
Date	DD/MM/YY	
Header	LINE 1	Customer info displays on print outs
	LINE 2	Customer info displays on print outs
	EXIT	
IR Print	KMIRP	Select to print to KMIRP
	IRP-2	Select to print to IRP-2
Temperature Scale	°C	Select °F or °C.
	°F	
Gas Unit	ppm	
	ppm(n)	
	mg/m3	
	mg/m3(n)	
	mg/kWh	
Language	English	
	Espanaol	
	Francais	
Efficiency	Gross	
	Net	
O2 ref		Used for "Normalized" readings.
Logs	VIEW	View current memory usage and view stored Logs
	DELETE ALL	
	EXIT	
Code		Password protected for authorized service agents only/ LEAVE SET TO "0000".

UTILITY SECTION

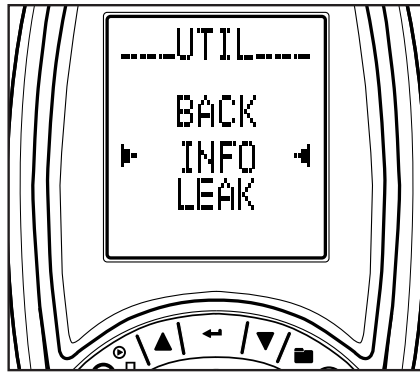
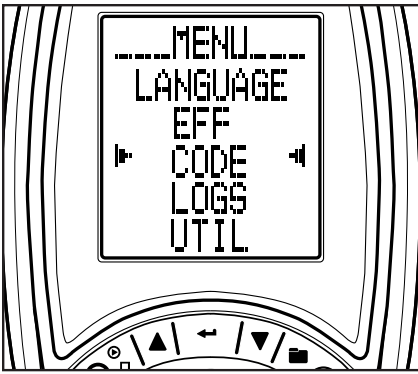

SETTING BACKLIGHT DURATION
 Rotate Roray Dial to MENU setting. Scroll to UTILITY selection
 Press ENTER button. Select duration: 15s, 30s, 45s, 60s, 300s
 Press ENTER button.

PERFORMING LEAK TEST
 Rotate Roray Dial to MENU setting. Scroll to UTILITY selection
 Press ENTER button. Select LEAK. Follow on display instructions. Press NEXT button.
 Allow countdown to proceed un- interrupted. Test will be PASS or FAIL.

STORED LOGS MEMORY

The C160 utilizes a shared memory system much like a computer hard drive. The different Log types are stored sequentially until the shared memory area is full. This means the log types are not restricted to a smaller number of memory locations as the full memory capacity is available as required for Logs of any type.

To view the current memory usage status simply navigate to menu -----> LOGS, press the button to select the Log desired.

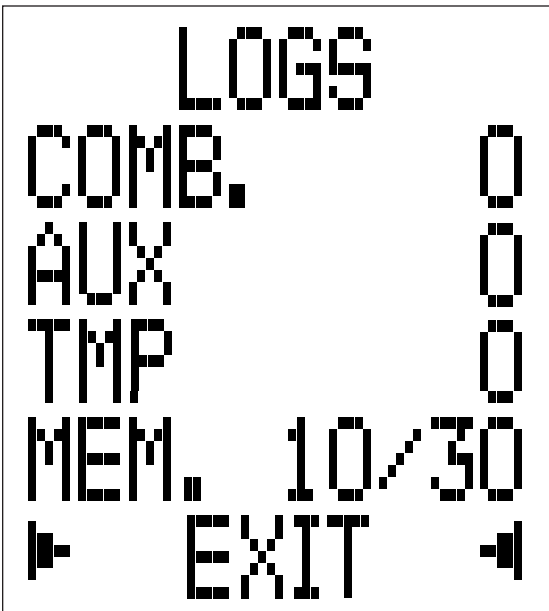

Number of stored Combustion Logs

Total Memory Used

Menu Options

Menu Options



View stored Logs, this will enter the secondary menu to select the type of log to view (will only appear if data available).

Delete all stored Logs. To delete "long press" the button (will only appear if data available).

Exit back to the Main Menu

Viewing Stored Logs

Once the view has been selected from the Logs Menu the following screen will be displayed:

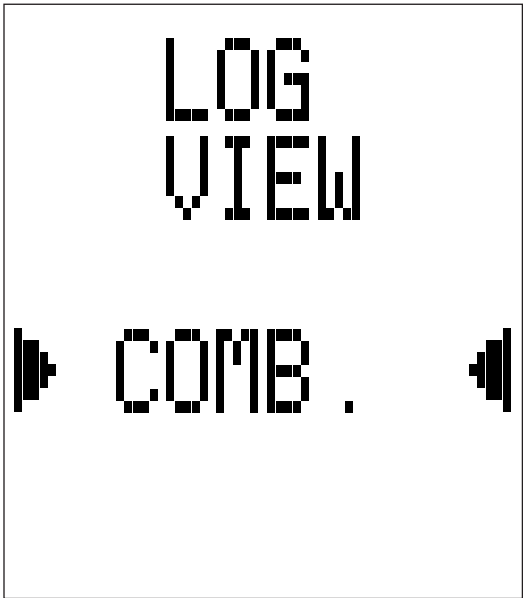

List of available Logs (Navigation and selection via the ▲, ▼ and ← buttons).

Log View Menu Options



View stored Combustion Logs (Option will appear if Logs are available).

Exit back to previous menu

Navigating Stored Logs

Once the desired Log type to view has been selected, the first available stored Log will be displayed.

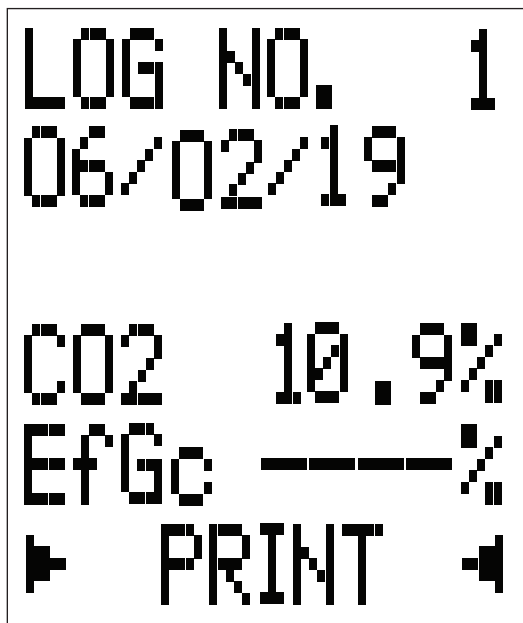

Log Number

Log time and date (this line will alternate between time and date of Log)

Log readings (information is specific to Log type)

Navigation Menu options

Log Navigation Menu Options

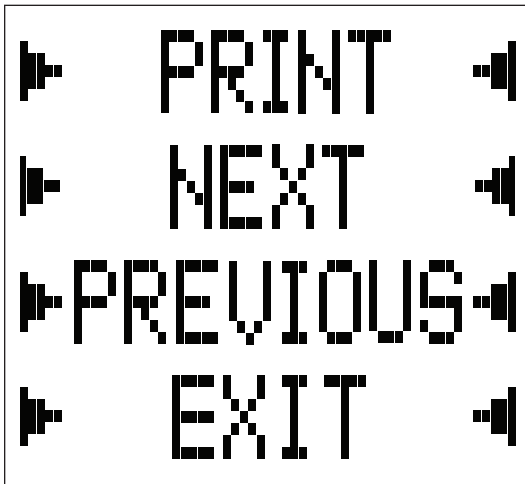

Print the currently selected Log

Navigate to the next available Log of the selected type (Option will only appear if there is more than one Log).

Navigate to the previously selected Log of the selected type (Option will only appear if there is more than one Log).

Exit back to the previous menu.

PRINTOUTS

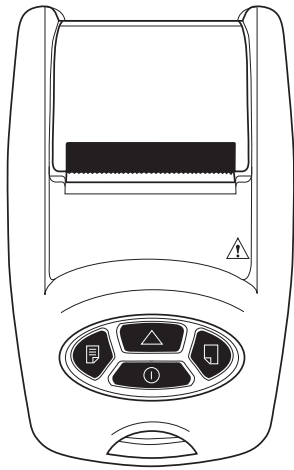

[IRP2]

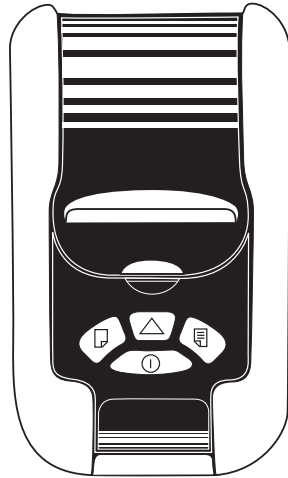

[IRP-3]

Selecting a Printer

Rotate selector Dial to **Menu** Position.

Use ▲ or ▼ buttons to scroll to **IR PRINT**.

Press ← button.

Use ▲ or ▼ buttons to select either **IRP-2** or **KMIRP** (KMIRP2) printer.

Press ← button to save selection.

Printing

To print, simply press and release the PRINT BUTTON. Printing can be aborted by pressing the PRINT BUTTON again.

UEi Infrared Printer

Make sure the printer is switched on, ready to accept data and its infrared receiver is in line with the meter's infrared emitter (on top of the meter).

Combustion

UEi		
C160 SW20157 v1.1		
NAME		
NUMBER		
SERIAL NO.	182721222	
DATE	08/19/21	
TIME	08:19:17	

CAL DUE	09/26/22	

COMBUSTION		

FUEL	NAT GAS	
02	%	20.76
T1	c	83.9
Ti	c	73.9
NETT	%	----
EFFgc	%	----
LOSS	%	----
XAIR	%	----

CUSTOMER		
.....		
.....		
.....		
REFERENCE		
.....		
.....		
.....		

SPECIFICATIONS

Parameter	Range	Resolution	Accuracy
Temperature Measurement Flue Temperature	32° to 1112°F (0° to 600°)	0.2°F (0.1°C)	±(0.3% rdg +3.6°F (2°C))
Flue Gas Measurement Oxygen	0 - 20.9%	0.1%	±0.3% Volume
Calculations Efficiency (Net or Gross) Efficiency High (C) Excess Air	0 - 99.9% 0 - 119.9% 0 - 119.9%	0.1% 0.1% 0.1%	±1% of Reading ±1% of Reading ±0.2% of Reading
Pre-programmed Fuels	Pellets, Light Oil, LPG, Butane, Propane, Natural Gas, Bio Oil, Heavy Oil		
Battery Life	>8 hours (continuous with pump on)		
Certification	The C160 is TUV-tested and certified to EN 50379, Parts 1-3 in accordance to 1st German Federal Emission Control Ordinance (Bim5chV)		
Operating Conditions Temperatures Humidity	32° to 113°F (0° to 45°C) 15 to 90% RH, (non-condensing)		
Power Supply	Rechargeable batteries, USB Charging		
Physical Characteristics Weight Dimensions	1.5 lb. (635g) H: 8.54" x W: 4.18" x D: 1.86" (H: 217 mm x W:106 mm x D: 47mm)		

The C160 is in conformity with the relevant Union harmonization legislation listed below:

Directive	Title
201430EU	Electromagnetic Compatibility (EMC)
201165EU	Restriction of the use of certain hazardous substances in electrical and electronic equipment (RoHS)

The following harmonized standards and technical specifications have been applied:

CERTIFICATION

The UEi C160 is TUV-tested and certified to EN 50379, Parts 1, 2 & 3 in accordance to 1st German Federal Emission Control Ordinance (BImSchV). Manufactured to meet AHRI 1260 standard.

EMC

EN507270:2015

Safety

EN61010-1:2010

RoHS

IEC62321-2:2013, IEC62321-1:2013; IEC62321-3-1;2013, IEC63321-5:2013, IEC623321-4:2013, IEC62321-7-2:2017, IEC62321-7-1:2015, IEC62321-6:2015

Air Conditioning / Heat Pump

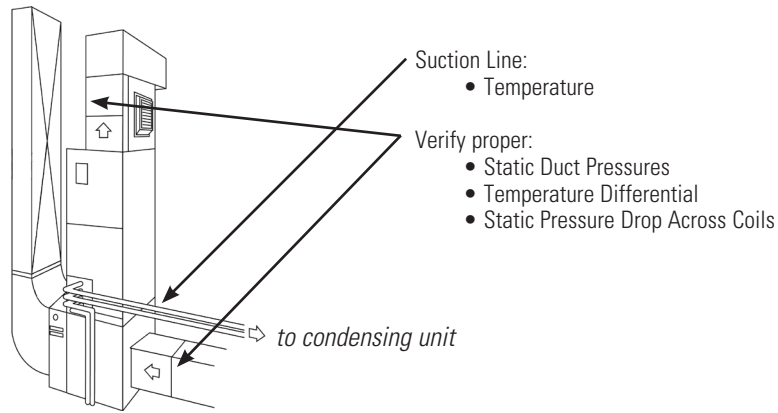

Boiler & Water Heaters & High Efficiency Modulating Hot Water Systems

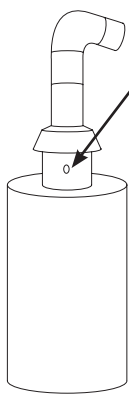

Boiler
 Verify proper combustion:
 • O₂
 • CO₂
 • Stack Temp
 • Stack Draft

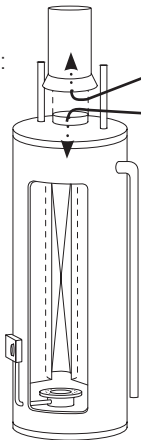

Water Heater
 Draft
 Verify proper combustion:
 • O₂
 • CO₂
 • Stack Temp
 • Efficiency

HE Boiler Instant Water Heaters

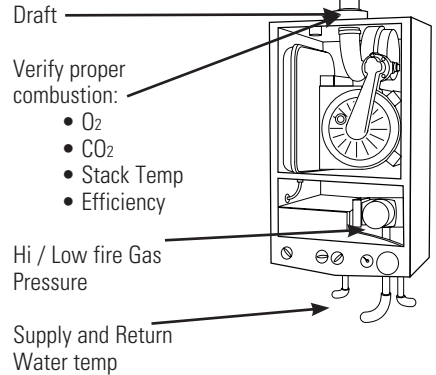

Furnaces: 80%

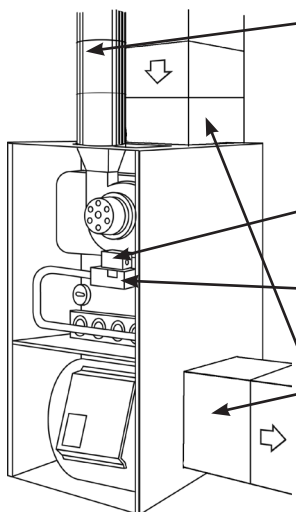

80% Furnace
 Verify proper combustion:
 • O₂
 • CO₂
 • Stack Temp
 • Vent Pressure
 • Efficiency

Verify/Set Up
 • Gas Pressure

Test
 • Limit Switch
 • Pressure Switch

Verify proper operation:
 • Static Duct Pressure
 • Temperature Rise
 • AC side Static Pressure Drop across coils

Furnaces: 90%

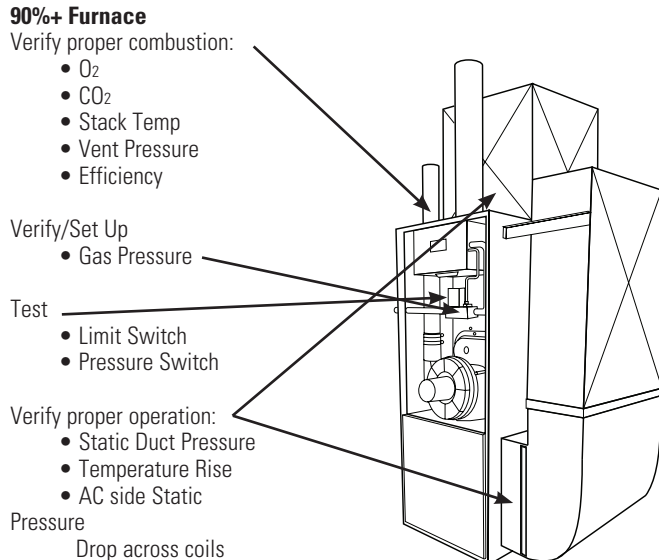

90%+ Furnace
 Verify proper combustion:
 • O₂
 • CO₂
 • Stack Temp
 • Vent Pressure
 • Efficiency

Verify/Set Up
 • Gas Pressure

Test
 • Limit Switch
 • Pressure Switch

Verify proper operation:
 • Static Duct Pressure
 • Temperature Rise
 • AC side Static Pressure Drop across coils

WHERE TO TEST (CONT.)

Furnaces (continued): Atmospheric, Gas & Oil

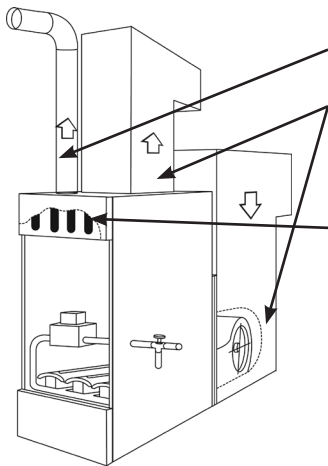

Atmospheric Furnace Draft

- Verify proper
- Temperature Rise
 - AC side Static Pressure
 - Drop across coils

- Verify proper combustion:
- O₂
 - CO₂
 - Stack Temp
 - Efficiency

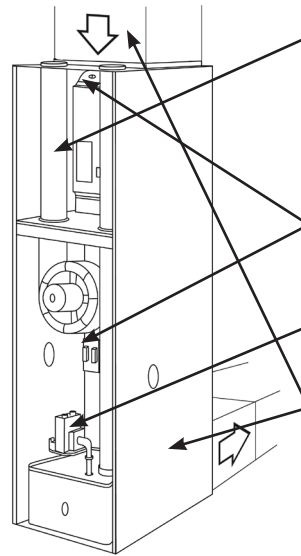

Natural Gas & Propane

Verify proper combustion:

- O₂
- CO₂
- Stack Temp
- Vent Pressure
- Efficiency

Test

- Limit Switch
- Pressure Switch

Set Up

- Gas Pressure

Verify proper:

- Static Duct Pressure
- Temperature Rise
- AC side Static Pressure
- Drop across coils

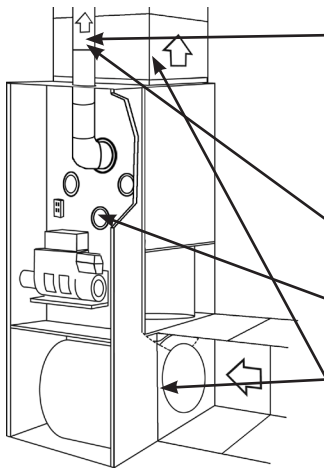

Oil Furnace

Verify proper combustion:

- O₂
- CO₂
- Stack Temp
- Stack Draft
- Efficiency

Test & Verify:

- Smoke

Set Up

- Over Fire Draft

Verify proper

- Static Duct Pressure
- Temperature Rise
- AC side Static Pressure
- Drop across coils

WHAT RESULTS ARE GENERALLY ACCEPTABLE

What Results Are Generally Acceptable

	Atmospheric Gas Fixed Burners	Gas Fired Burners	Oil Fired burners (#2 Oil Fuel)	Positive Overfire Gas & Oil
Oxygen	7 to 9% O ₂	3 to 6% O ₂	4 to 7% O ₂	3 to 9% O ₂
Stack temperature	325°F to 500°F	275°F to 500°F	325°F to 600°F	
Draft (Water Column Inches)	-.02 to -0.4 InWC	-.02 to -0.4 InWC	-.04 to - 0.6 InWC	-.02 to -0.4 InWC
Overfire Draft (Water Column Inches)		-.02 InWC	-0.2 InWC	0.4 to 0.6 InWC
Smoke			0 (manufacturer's recommendation)	

NOTE: Follow manufacture guidelines for the specific equipment being serviced

Typical Excess Air Level

	O2% (measured)	Excess Air %
Natural Gas	3%	16.7%
LIGHT Oil	5%	31%
Coal	8%	62%

POWERING OFF

When you power off the C160, there is a 45 second purge.

Make sure you do not exceed the meter's operating specifications. In particular:

- Do not exceed the flue probes maximum temperature (1112°F, dependent on flue probe used)
- Do not exceed the meter's internal temperature range
- Do not put the meter on a hot surface
- Do not exceed the water trap's level
- Do not let the particle filter become dirty and blocked

View the displayed data to ensure that the stable operating conditions have been achieved and the readings are within the expected range.

POST TEST

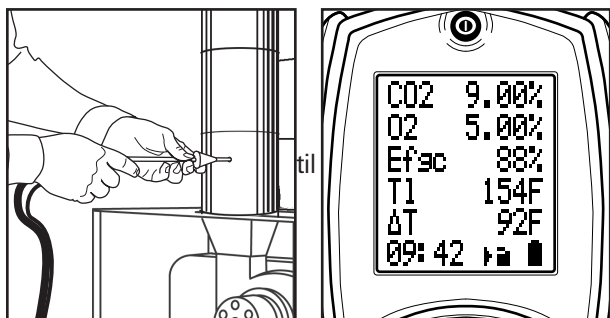

Remove the probe from the flue and allow meter to purge with fresh air until readings return to zero. O₂ to 20.9% (Be careful the probe tip will be HOT).

GENERAL MAINTENANCE

- Re-certify your instrument annually to ensure it meets original performance specifications.



PERIODIC SERVICE WARNING

Repair and service of this instrument is to be performed by qualified personnel only. Improper repair or service could result in physical degradation of the instrument. This could alter the protection from personal injury this meter provides to the operator. Perform only those maintenance tasks that you are qualified to do.

- Keep your instrument dry. If it gets wet, wipe dry immediately. Liquids can degrade electronic circuits.
- Whenever practical, keep the instrument away from dust and dirt that can cause premature wear.
- Although your instrument is built to withstand the rigors of daily use, it can be damaged by severe impacts. Use reasonable caution when using and storing the meter.

COLD WEATHER PRECAUTIONS

It is important you keep your residential combustion meter in a warm and dry place overnight

Electronic devices that become really cold, by being left in a vehicle overnight, suffer when taken into a warm room the next morning. Condensation may form which can affect the meter's performance & cause permanent damage. See operating and storage temperature specifications.

Electrochemical sensors used in flue gas meters can be affected by condensation or water being sucked into the meter, as the small apertures on top of sensors can become blocked with water, stopping sensors seeing flue gas. When this happens, oxygen or carbon dioxide reading will display as "—" & sensors may be permanently damaged

If you think that your meter is affected by condensation or water ingress, it may be possible to rectify the problem yourself. Simply leave the meter running in a warm place, with the pump 'ON' sampling fresh air for a few hours (use mains adapter/battery charger if needed). If, after doing this, you still experience problems please contact our Service Center.

REPLACING THE BATTERIES

This meter has been designed for use with both alkaline and rechargeable Nickel Metal Hydride (NiMH) batteries. No other types are recommended and will void warranty. The meter is supplied with 3 (AA) size NiMH rechargeable batteries. These should be installed into the instrument.



CAUTION

Take great care when installing the batteries to observe correct polarity. Always check the meter for operation immediately after installing new batteries.

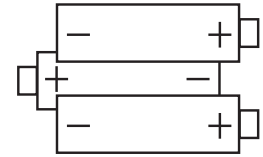

Using Rechargeable Batteries

The battery charger must only be used when NiMH batteries are fitted. Alkaline batteries are not rechargeable. Attempting to recharge alkaline batteries may result in damage to the product and create a fire risk.



WARNING

Do not try and charge the unit with Alkaline batteries fitted. Do not mix NiMH cells of different capacities or from different manufacturers, all cells must be identical.

Turn over the meter, remove the protective rubber boot and fit 3 "AA" NiMH rechargeable batteries in the battery compartment. **Take great care to ensure they are fitted with the correct battery polarity.** Replace the battery cover and the protective rubber boot.

Time and Date

When changing the batteries, the time and date will need setting.

Battery Disposal

Always dispose of depleted batteries using approved disposal methods that protect the environment.

Battery Charging

Ensure that you use the correct charger. This unit uses a 5V regulated charger. Ensure the batteries are fitted in the correct manner, and charge for at least 16 hours. Subsequent charges should be overnight. NiMH batteries may be charged at any time, even for short periods to conduct testing.

WARNING



Under NO circumstances should you expose batteries to extreme heat or fire as they may explode and cause injury. Always dispose of old batteries promptly in a manner consistent with local disposal regulations.



Complete care for your C160 series combustion analyzer.

When you:

***Request Recertification or Service Online
Within 1 Year of Purchase or Service***

UEi will:

6-Year Warranty: All UEi combustion meters have a standard 1-year warranty. Each recertification includes a 30-point inspection and extends the warranty for 1 more year for up to 6 years from the date of warranty.

Contractors who book recertification of a C160 series meter at www.ueitest.com/service within 12 months from either the date of purchase or the date of the last recertification will receive reduced service pricing that lowers the cost of ownership and 2 additional benefits:

24-hour Service: Meters received for standard recertification and service through UEi Service+ are shipped back on the next business day.

Free Shipping: UEi Service+ offers free shipping both to and from our service center. When customers book their recertification, they receive a prepaid UPS Ground shipping label.

Get full details at www.ueitest.com/service



PRODUCT REGISTRATION

Register Online

Registering your meter online is quick and easy. Just log in or setup an account, it only takes a couple of minutes. Once logged in you can register your meter by providing some product information and uploading a proof-of-purchase.

When it's time to request recertification, just log into your account, select the meter, select the service and place your order.

OTHER IMPORTANT FACTORS RELATING TO COMBUSTION

The three T's of combustion

- **Time:** Amount of time that the fuel and oxygen are together in the combustion chamber
- **Temperature:** How high the temperature is determines the rate of oxidation, or spread of combustion
- **Turbulence:** How well the fuel and air are mixed

These three factors are all interrelated and will move your results along the combustion curves.

COMBUSTION MEASUREMENT TERMS

Other parameters measured include Net temperature, draft and efficiency.

Net Temperature

Net temperature is the difference between the combustion air entering the combustion chamber and the flue gas temperature past the heat exchange. This is used to determine how efficient the system is extracting heat from the combustion process in addition to the performance of the combustion process. On sealed systems that have ducted inlet air for combustion air, the Net temperature must compare this air stream temperature with the flue gases. If the appliance simply uses room air for the combustion air, our meters have an internal temperature sensor in the handset, so it will use this temperature when calculating Net temperature. The most accurate results for efficiency are obtained when measuring flue gases at the point where flue temperature (not flame temperature) is the highest.

Draft

Draft is the difference between the ambient pressure level and the pressure level in the flue.

This is created either by the natural buoyancy of the hot gases created in combustion lifting, or by an inducer fan that assists the flow of flue gases up the stack. Most combustion equipment will specify the amount of draft that is required for proper operation. Draft helps draw combustion air into the combustion chamber, and also helps in mixing the fuel and oxygen. Without proper draft, the combustion process can spill poisonous by-products into the space where the appliance is located. This can be a risk to those in the area, or create a danger to residents or employees working near the combustion equipment.

Efficiency

Efficiency is a measure of how well the fuel is burned to create heat, and how well the generated heat is captured for the intended use. The information used to create this value are based on the fuels heating value, the heat lost up the flue and the gas components in the flue gas. The original method to determine efficiency included many manual methods and lookup charts. As an example you would measure the CO₂ level and the stack temperature and then reference a slide scale that would give you the relative efficiency number. UEi's electronic combustion meters perform the measurements on a continuous basis, and can calculate the efficiency as adjustments are being made. Combine this with a printout and you are able to provide a before and after comparison of the combustion equipment in relatively little time as part of normal servicing. **Combustion efficiency is not the same as AFUE (annual fuel usage efficiency). AFUE is not measurable with any portable flue gas analyzer.**

Combustion Efficiency Calculations

This identifies three sources of loss associated with fuel burning:

- Losses due to flue gases:
 - Dry Flue gas loss, Moisture and hydrogen,
 - Sensible heat of water vapor, Unburned gas
- Losses due to refuse:
 - Combustible in ash, riddling and dust
- Other losses:
 - Radiation, convection, conduction other unmeasured losses

Net efficiency calculations assume that the energy contained in the water vapor (formed as a product of combustion and from wet fuel) is recovered and the wet loss term is zero. Gross efficiency calculations assume that the energy contained in the water vapor is not recovered. Since the fuel air mixture is never consistent there is the possibility of unburned/partially unburned fuel passing through the flue. This is represented by the unburned carbon loss. Losses due to combustible matter in ashes, riddling, dust and grit, radiation, convection and conduction are not included.

DISPOSAL



Caution: This symbol indicates that equipment and its accessories shall be subject to separate collection and correct disposal.

CLEANING

Periodically clean your meters' case using a damp cloth. DO NOT use abrasive, flammable liquids, cleaning solvents, or strong detergents as they may damage the finish, impair safety, or affect the reliability of the structural components.

STORAGE

Remove the batteries when instrument is not in use for a prolonged period of time. Do not expose to high temperatures or humidity. After a period of storage in extreme conditions exceeding the limits mentioned in the General Specifications section, allow the instrument to return to normal operating conditions before using it.

WARRANTY

The C160 is warranted to be free from defects in materials and workmanship for a period of 1 year from the date of purchase. If within the warranty period your instrument should become inoperative from such defects, the unit will be repaired or replaced at UEi's option. This warranty covers normal use and does not cover damage which occurs in shipment or failure which results from alteration, tampering, accident, misuse, abuse, neglect or improper maintenance. Batteries and consequential damage resulting from failed batteries are not covered by warranty.

Any implied warranties, including but not limited to implied warranties of merchantability and fitness for a particular purpose, are limited to the express warranty. UEi shall not be liable for loss of use of the instrument or other incidental or consequential damages, expenses, or economic loss, or for any claim or claims for such damage, expenses or economic loss.

A purchase receipt or other proof of original purchase date will be required before warranty repairs will be rendered. Instruments out of warranty will be repaired (when repairable) for a service charge

For more information on warranty and service, contact:

www.ueitest.com Email: info@ueitest.com
1-800-547-5740

This warranty gives you specific legal rights. You may also have other rights, which vary from state to state.