

CST775
CST776
CST785
CST786

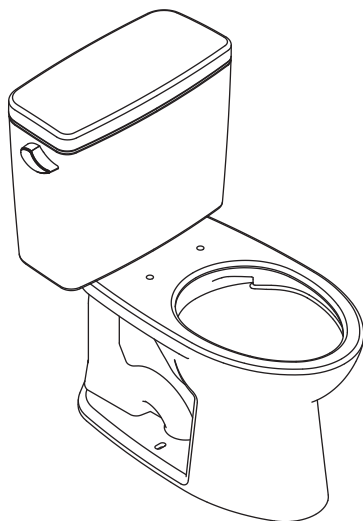

- * Actual parts may appear different from drawing according to the model.
- * El producto real puede variar en apariencia dependiendo del modelo.
- * Le produit réel peut varier en apparence en fonction du modèle.

Warranty Registration and Inquiry

For product warranty registration, TOTO U.S.A. Inc. recommends online warranty registration. Please visit our website <http://www.totousa.com>. If you have questions regarding warranty policy or coverage, please contact TOTO U.S.A. Inc., Customer Service Department, 1155 Southern Road, Morrow, GA 30260 (888) 295-8134 or (678) 466-1300 when calling from outside of U.S.A.

TABLE OF CONTENTS

Thanks for Choosing TOTO!.....	2
Common Tools Needed	2
Included Parts	2
Before Installation.....	3
Installation Procedure	3
Care and Cleaning.....	5
Maintenance Instructions.....	6
CEFIONTECT®Cleaning Instructions.....	7
Warranty	8

THANKS FOR CHOOSING TOTO!

The mission of TOTO is to provide the world with healthy, hygienic and more comfortable lifestyles. We design every product with the balance of form and function as a guiding principle. Congratulations on your choice.

COMMON TOOLS NEEDED







- | | |
|---|--|
| <ul style="list-style-type: none"> • 10" adjustable wrench • Carpenter's Level • Hacksaw • Tape Measure | <ul style="list-style-type: none"> • Hand Pliers • Flat Screwdriver • Putty Knife |
|---|--|

ADDITIONAL ITEMS (NOT SUPPLIED BY TOTO):

- Bowl Wax Ring
- Closet Flange Mounting Bolts
(usually 2 T-bolts, 2 metal washers and 2 nuts)
- Water Supply Line
(typically 1/2" compression to 7/8" ballcock)
- Toilet Seat (TOTO SoftClose recommended)

INCLUDED PARTS

Check to make sure you have all these parts from the package:

 Bowl	 Tank	 Tank to Bowl Gasket
 Bolts (metal) - 2 Washers (rubber) - 2	 Washers (metal) - 4 Nuts (metal) - 4	 Caps (plastic) - 2 Base (plastic) - 2
 Fill Valve Cone Washer - 1 Fill Valve T-Nut - 1		

BEFORE INSTALLATION

- Read these instructions thoroughly before beginning work.
- Please leave instructions for customers. These instruction contain maintenance and warranty information.
- If necessary, remove the existing toilet.

IMPORTANT!

Due to the powerful performance of our Tornado, G-Max, E-Max and Power Gravity flushing systems, they are not specified for back-to-back installations. The only means of installing these toilets in a back-to-back situation is when the toilet drain connections incorporate a WYE fitting. Please contact your builder or contractor prior to this installation.

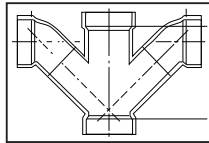

Double Combination WYE / 1/8 Bend
YES

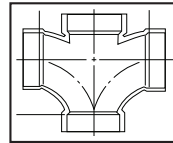

Double Sanitary Tee / Sanitary Cross
NO

For your new TOTO toilet to fit correctly, the rough-in, the distance between the finished wall to the center of the closet flange, must be at least 12 inches for most models.

NOTE: Models with 10" rough-in have model numbers ending with ".10", for example C776CEFG.10.

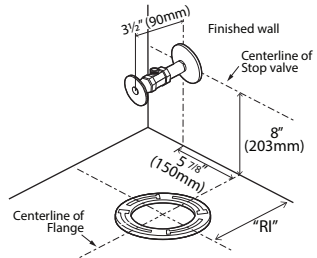

INSTALLATION PROCEDURE

- 1) Clean any debris out of the closet flange and then install new mounting bolts (not supplied) into the slots of the closet flange (see ill. 1). The head of the bolt should be inserted into the slot with its threads facing upward.
- 2) Carefully turn the toilet upside down onto some padding. Firmly press a new bowl wax ring (not supplied) onto the circular recess around the toilet bowl's horn (see ill. 2). Turn the toilet upright and gently lower into position over the closet flange. With toilet properly aligned, press firmly on both sides of toilet rim to set the bowl wax ring (see ill. 3).

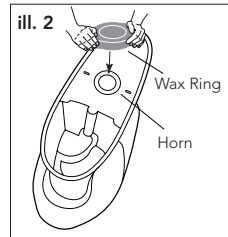
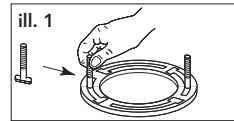

CAUTION: Do not move the bowl after the bowl wax ring is set. Thread the nuts and tighten evenly until bowl is snug to closet flange. Install the bolt caps (see ill 3).

CAUTION: Do not overtighten the nuts as damage to the china bowl may result.

NOTE: Rocking may occur depending on the condition of the flooring. In that case, use shims to prevent the toilet from rocking.

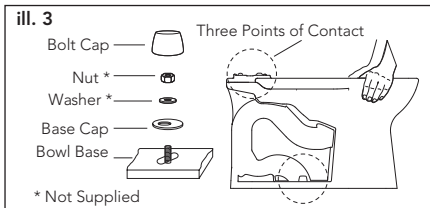

INSTALLATION PROCEDURE

NOTE: Three Points of Contact:

The toilet bowl has three points of contact, which will actually contact the bottom of the toilet tank when properly installed. The location of these points can be seen on the bowl at the tank receiving area. The three points are front left (1), front right (2), and back center (3). Recall these three points during the Toilet Tank installation.

Points of Contact

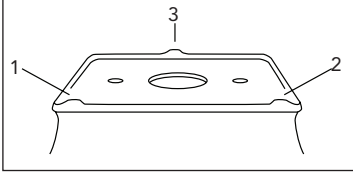

- 3) Place the tank upside down onto some padding. Inspect the smaller fill valve nut and larger flush valve nut for a secure connection (see ill. 4). Try to tighten the nuts with your hands. If loose, tighten the nut hand tight and an additional 1/4 turn for the smaller fill valve nut and an additional 1/2 turn for the larger flush valve nut.

Place the tank-to-bowl gasket onto the flush valve nut. While pressing down, spread the gasket over the nut until the gasket touches the bottom of the tank. A slight gap between the tank bottom and the gasket is allowable.

ill. 4

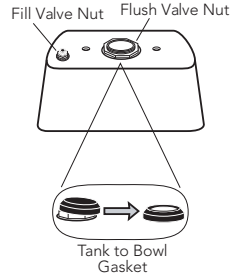

- 4) Lay the tank down on its back. Place a rubber washer onto a bolt (see ill. 5). Reach inside the tank and position the bolt through one of the holes in the bottom of the tank. On the outside of the tank, place a metal washer and nut onto the bolt. Hold the bolt centered in the hole and tighten the nut finger tight. Turn the nut an additional 1/2 turn with a wrench. Repeat this process for the remaining hole in the tank.

ill. 5

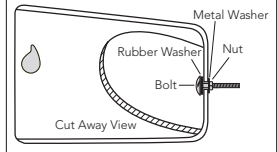

- 5) Pick up the tank and carefully guide the bolts to align the tank with the bowl. Attach a metal washer and nut to each bolt (see ill. 6A).

ill. 6A

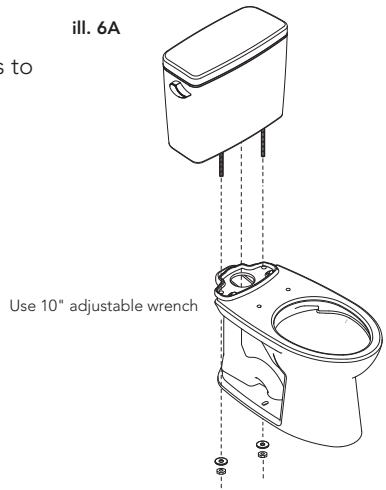

INSTALLATION PROCEDURE

Tighten until tank makes **THREE POINTS OF CONTACT** with the bowl (see ill. 6B).

- 6) Flush the water supply line for a few seconds to remove any debris that may enter the new fill valve.

(For new home constructions and/or additions, flush the water supply line for more than a minute to help remove any residual PVC adhesives, solder flux, and/ or pipe sealants that were used for the new plumbing.)

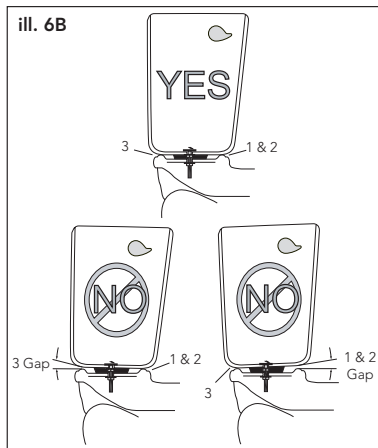

Connect the water supply line to the fill valve threads as seen at the bottom of toilet tank (see ill. 7).

Tighten this connection finger tight.

CAUTION: Avoid using a wrench to tighten the connection as you may damage the plastic threads and/or cause the fill valve to rotate inside the tank.

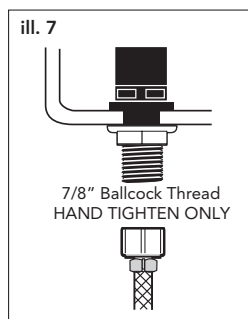

NOTE: The water supply pressure should be 20 to 80 psi static.

- 7) Turn water supply ON and check for leaks from the tank. Flush the toilet a few times to check for issues and leaks. Make sure **NO WATER LEAKS** on the bowl and tank.
- 8) After there are no more leaks, caulk the base of the toilet.
- 9) Install the toilet tank lid onto the toilet tank top.

CARE AND CLEANING

WARNING!

DO NOT USE IN-TANK BOWL CLEANERS.

The use of high concentration of chlorine or chlorine-related products can seriously damage fittings in the tank. This damage can cause leakage and property damage. TOTO shall not be responsible or liable for any tank fitting failure or damage caused by the use of in-tank bowl cleaners.

MAINTENANCE INSTRUCTIONS

Fill Valve Installation Procedure

- 1) Shut off the water supply to the toilet.
- 2) Flush toilet and remove remaining water from tank with a sponge.
- 3) Remove the water supply connection at the fill valve.
- 4) Remove old fill valve and use damp sponge to clean fill valve hole in tank.
- 5) Place new fill valve inside tank hole.
- 6) Thread mounting nut onto fill valve shank and tighten the nut.

NOTE: Do not overtighten. Be sure to install fill valve in a position that does not interfere with the trip lever operation.

- 7) Connect water supply to fill valve shank and hand-tighten only.

NOTE: Do not overtighten. These are plastic parts. Never use pipe dope on any water supply connection.

- 8) Attach refill tube to fill valve nipple and clip other end of refill tube to the overflow pipe.
- 9) Turn water supply ON and check for leaks outside the tank.

NOTE: As water fills the tank, water is also directed into the overflow tube via the refill tube. This additional flow of water is critical to refilling your toilet's bowl. Once the water stops filling the tank, some residual drops of water may drip from the fill valve. This is NORMAL as these drops will subside.

Water Level Adjustment

Depending on the manufacturing plant, you may have one of two of the following fill valves:

Type A

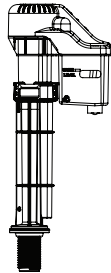

For Type A Fill Valve:

There are no water level adjustments. The fill valve has been preset at the factory.

Type B

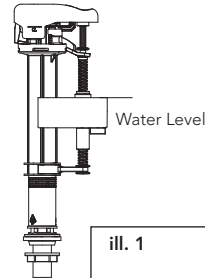

For Type B Fill Valve:

Refer to the water level (WL) setting on the tank label. Allow the water to fill the tank. Turn the adjustment screw clockwise in the (+) direction to increase the water level height (see ill 1). Turn the adjustment screw counter-clockwise in the (-) direction to decrease the water level height. Flush the toilet to verify the correct water level. Adjust as necessary.

ill. 1

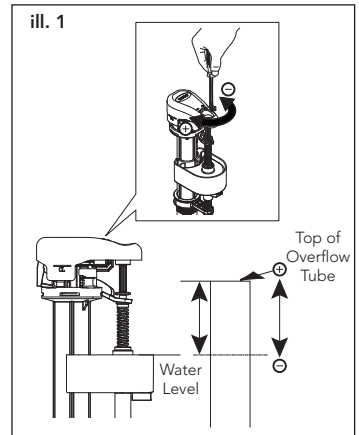

MAINTENANCE INSTRUCTIONS

Replacing the Flush Valve

- 1) Shut off the water supply.
- 2) Flush the toilet to remove the water inside the tank.
- 3) Remove the tank lid and place somewhere safe.
NOTE: Before removing anything from the tank, note the placement of the flush valve, chain and refill tube.
- 4) Unhook the refill tube from the overflow tube of the flush valve.
- 5) Unhook the chain from the trip lever.
- 6) Uninstall the tank (refer to the toilet installation manual).
- 7) Remove the flush valve body from the tank.
- 8) Replace the flush valve in the same position as the former flush valve.
- 9) Hand tighten the mounting nut of the flush valve and use a wrench to tighten another 3/4 turn.
- 10) Reinstall the tank onto the bowl and place the chain and refill tube the same way as it was for the former flush valve.
- 11) Turn the water supply back.
- 12) Check for any leakage after the tank has been filled.

ill. 1

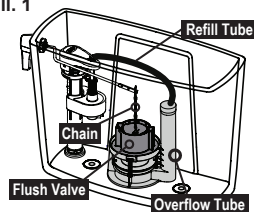

ill. 2

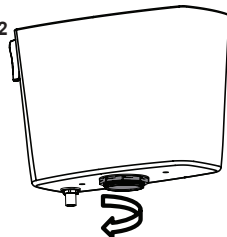

ENGLISH

CEFIONTECT® CLEANING INSTRUCTIONS



WHAT IS CEFIONTECT®?

CEFIONTECT® is TOTO's super-smooth permanent glaze that prevents debris from sticking to surfaces. Products with the letter "G" in the number have the CEFIONTECT® glaze. This glaze, along with regular cleaning, will help keep your TOTO product in pristine condition.

NOTE:

For best results to keep your Toto product with CEFIONTECT® clean:

- Lavatory: Use a mild dish detergent with a clean, soft cloth.
- Toilet: Use a gel based cleaner with a soft bristled-plastic brush.
- **Don't use** cleaners, polishing powders or detergents that have gritty or coarse particles.
- **Don't use** bleach, chemical thinners or products that have acid or alkaline detergents listed as ingredients.
- **Don't use** metal scrub brushes or steel wool.

Following these instructions will ensure that your TOTO product with the CEFIONTECT® glaze will always stay intact, keeping your product like new for years to come!

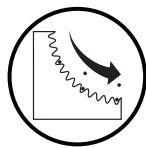

No CEFIONTECT®

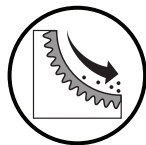

With CEFIONTECT®

