

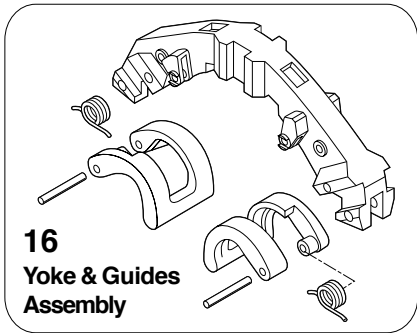

PIPE TOOLS & VISES
SINCE 1896

Low Clearance Rotary™ Cutters

Replacement Parts

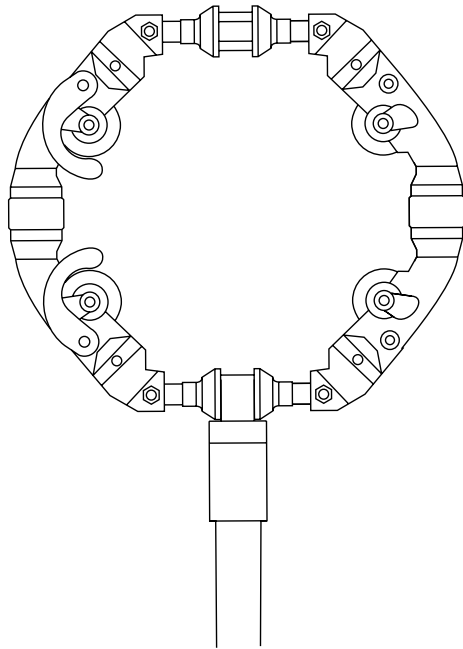

16
Yoke & Guides
Assembly

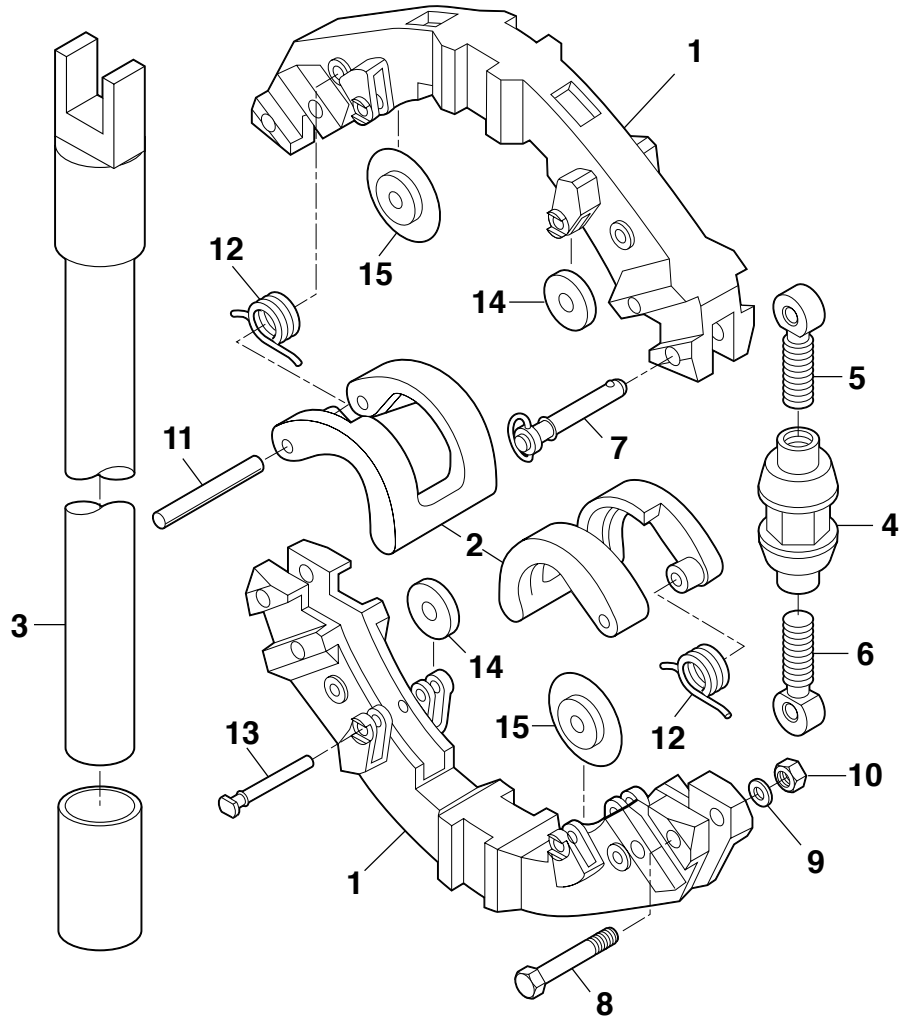

Parts List

Ref. No.	Description	LCRC8		LCRC12		LCRC16		
		Item Code	Qty. Used	Item Code	Qty. Used	Item Code	Qty. Used	
1	Yoke	93174	2	93175	2	93171*	2	
2	Guide	93165	2	93166	2	93166	2	
3	Handle Assembly	93176	1	93176	1	93176	1	
4	Turnbuckle	93169	2	93169	2	93169	2	
5	Rod End Right Hand	93172	2	93172	2	93172	2	
6	Rod End Left Hand	93173	2	93173	2	93173	2	
7	Release Pin	40147	1	40147	1	40147	1	
8	Cap Screw	30091	3	30091	3	30091	3	
9	Lock Washer	30093	2	30093	2	30093	2	
10	Hex Nut	30150	2	30150	2	30150	2	
11	Guide Pin	30090	2	30090	2	30090	2	
12	Guide Spring	40321	2	40151	2	40343*	2	
13	Wheel Pin Assembly	93200	4	93200	4	93200	4	
14	Roller	93220	8	93220	8	93220	8	
15	Cutter Wheel	See cutter wheel reference chart in catalog or price list.						
16	Yoke with Guides	93307	1	93314	1	93318	1	

*40340 Guide Spring used on 93096 Yoke on cutters manufactured before December 2009.

Reed Manufacturing Company
1425 West 8th Street
Erie, PA 16502 USA

QUALITY
& Service
that Last a Lifetime

Phone: 800-666-3691 or 814-452-3691
Fax: 800-456-1697 or 814-455-1697
www.reedmfgco.com

RP-0314-45