

American Standard

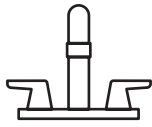

American Standard is devoted to making life, in the heart of your home, better every day...

...so, thank you for inviting us in! With the very best in kitchen and bathroom products, we are here to help make your life happier, healthier and simpler. Our commitment to quality, innovation and performance has made us part of your everyday routine for nearly 150 years, and we look forward to being a part of your life for many years to come.

Learn more at www.AmericanStandard.com

REGISTER YOUR WARRANTY

Try the easy-scan **QR code** to quickly enter your information or find your product's detailed warranty here:

www.AmericanStandard.com/warranty



Registering allows you to keep your product information safe, and us the ability to contact you in the event of a product recall or *any* news about your purchase.

And if ever you have a question or need help...?

Call us at 1-855-815-0004

OWNERS MANUAL

Aspirations™ Shelf Unit

7192000

RECOMMENDED TOOLS AND MATERIALS

Installation steps will indicate which tools should be used with associated letter



A Level

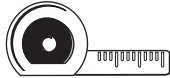

B Tape Measure

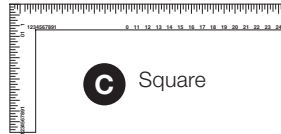

C Square



D Pencil



E Painter's Masking Tape

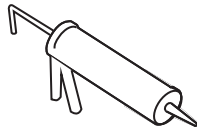

F Caulking Gun

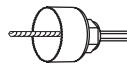

G Hole Saw



H Safety Equipment

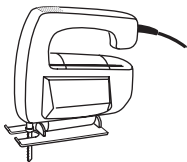

I Jig Saw with fine tooth blade

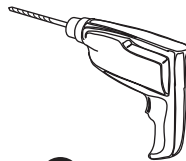

J Drill

Sold Separately: 2 Tubes Waterproof Instant Grab Adhesive: 2 Tubes Tub and Tile Sealant.

BOX CONTENTS

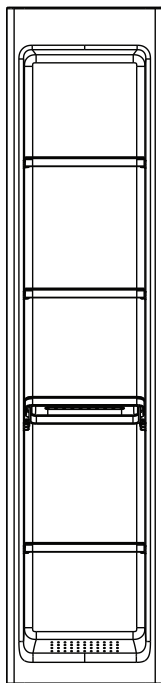

X1 Shelf Unit

TOP SHELF DISHWASHER SAFE

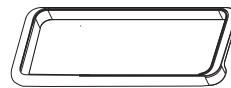
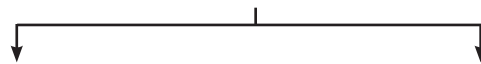

X4 Frames

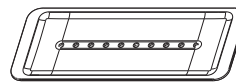

X3 Shelves

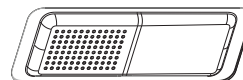

X1 Soap Shelf

INSTALLATION INSTRUCTIONS

IMPORTANT GENERAL INFORMATION

NOTE: The Aspirations Shelf Unit should be prepared for installation **BEFORE** the alcove is closed in with Dry Wall or Finished Wall material.

This unit is best installed by two people.

Cover drain with tape prior to installation to prevent the loss of small parts.

Unpack your unit carefully and inspect for freight damage. Lay out and identify all parts using Box Contents as a reference. Before discarding the carton check to see that no small hardware parts have fallen to the bottom of the box. If any parts are damaged or missing refer to the description noted in the instructions when inquiring about replacements.

Be sure to wear safety glasses whenever drilling or cutting.



BEFORE YOU BEGIN

Local building codes vary by location. Observe all local plumbing and building codes.

Unpack your new shelf unit and inspect them carefully for damage. Verify that the shelf unit are the correct size for your installation. **NOTE: Take extra care in handling the front surfaces of the shelf unit Use only non-abrasive cloths to avoid scratching.**

1

PREPARATION

1. Dry fit bath tub, place tub into alcove and locate desired position for Shelf Unit onto the wall. Install vertical studs as needed.

NOTE: If installing optional Aspirations Shower door, install additional studs for support at #1, #2, #3 (ref. ill).

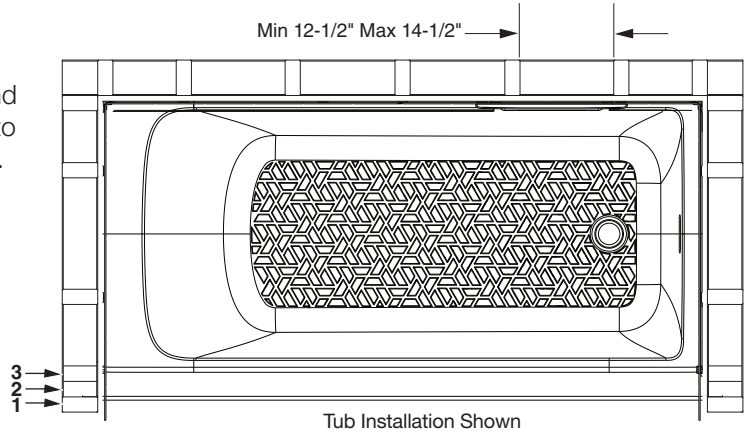

2. Install optional horizontal supports where needed. Space between top to bottom horizontal support is 59".

NOTE: For a retro fit, minimum inside stud to stud dimensions should be 12-1/2". Can also accommodate standard 16" center to center spacing as well.

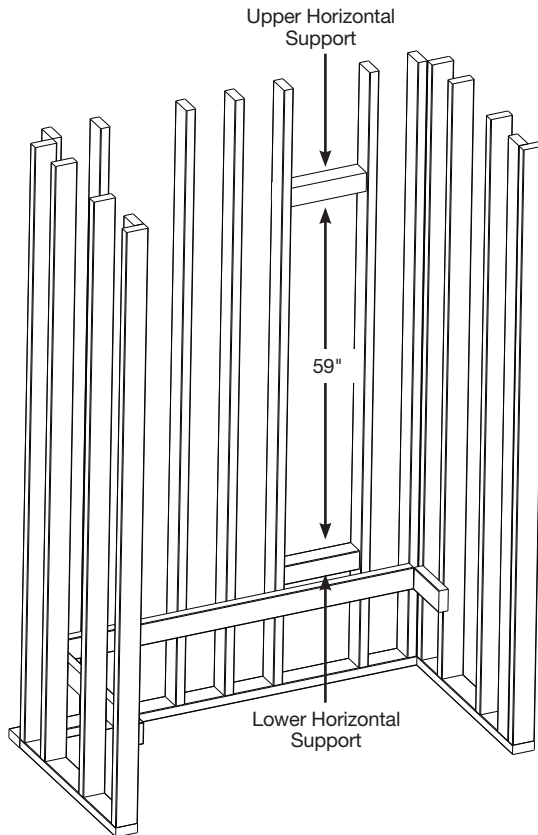

2

SHELF UNIT INSTALLATION

1. For Shelf Unit installation with a tub, place Shelf unit into position while leaving a 1/8" gap between bottom edge of Shelf Unit and deck of tub. Remove Shelf unit and tape shims into place on the deck of tub using painters tape.

3

HORIZONTAL SUPPORT

1. Suggested position top edge of lower horizontal support" at 2-7/8" above the deck of the bath is lowest position. Ensure the bottom firmly contacts the Shaving Support area of the Shelf Unit.
Shim if necessary to ensure good contact of the Shaving Support area in the Shelf Unit to the horizontal support to reduce possible flexing.

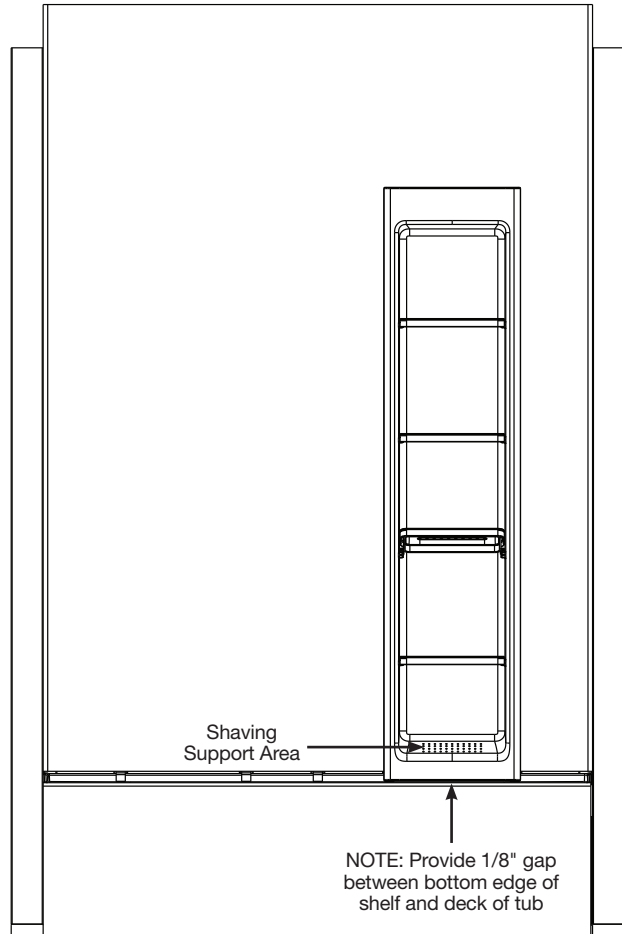
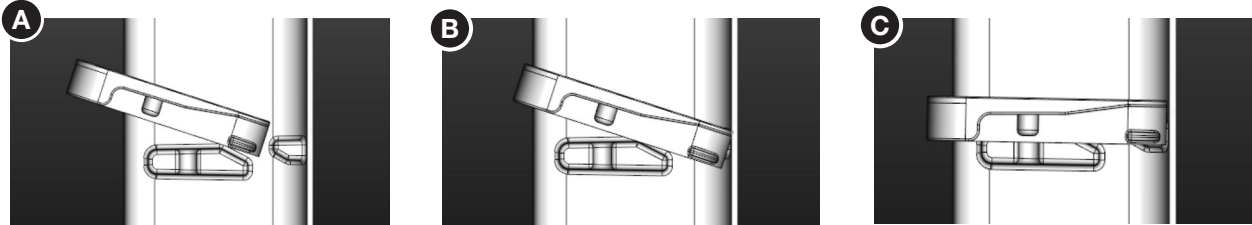

Illustration 3

4

FRAME INSTALLATION STEPS

1. **IMPORTANT:** Insert all 4 Shelf Frames locked into position (ref. Illustration). Temporarily tape Shelf Frames into position using painters tape to maintain correct fit of frames into Shelf Unit **BEFORE** final installation.



5

DRYWALL INSTALLATION

1. Install all drywall around alcove area, then cut out area of 59" tall x 12-1/2" wide where Shelf Unit will be installed. Place Shelf Unit into position onto the drywall and check for correct fit. Ensure the insides of the Shelf Unit do not rub on or distort the inside walls of the shelf or interfere with the installed Frames operation.

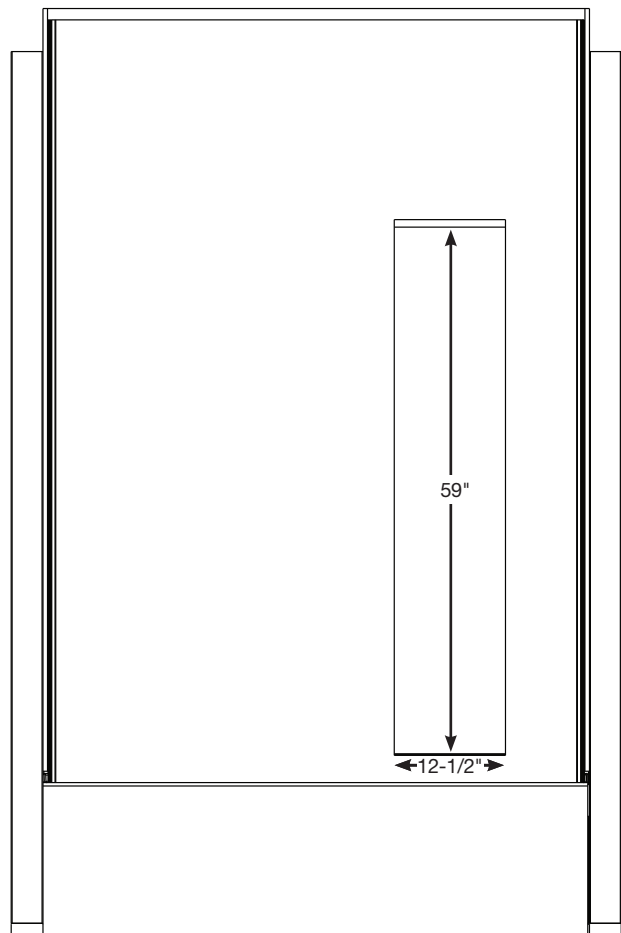

6

SHELF UNIT INSTALLATION

1. Transfer the 59" Tall X 12-1/2" wide dimension from the drywall onto the Aspirations Wall Panels and cut out area around where the Shelf Unit will be installed. Dry fit both finished walls and Shelf Unit onto wall to ensure fit is correct.

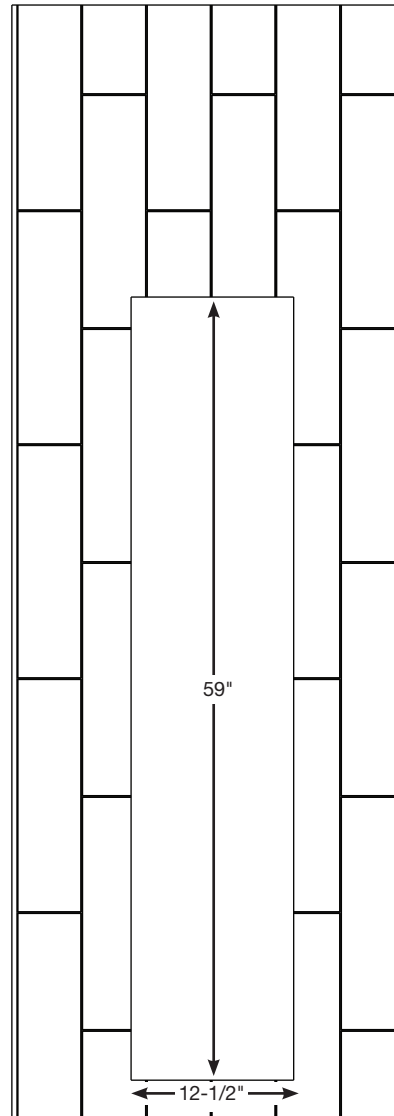

7

SHELF UNIT INSTALLATION

1. Install Aspirations Finished Wall panels or finished wall panels as per those instructions.

SHELF UNIT INSTALLATION

1. Once finished wall panels have been installed, dry fit the Shelf Unit again ensuring fit of Shelf Unit around opening in wall is correct with no binding or rubbing on the insides of the Shelf Unit. Then apply 1/4" to 1/2" bead of caulk around the back side flange area of the Shelf Unit. Also apply adhesive/silicone on "Lower Horizontal Support" (if installed). (ref. illustration for step 8). When installing Shelf Unit start on the bottom edge first to contact the 1/8" spacer on the deck of the bath. Then push in fully onto the Aspirations Wall Panels or finished wall. Remove any excess caulk. Then apply painters tape on the Shelf Unit to hold in position overnight.

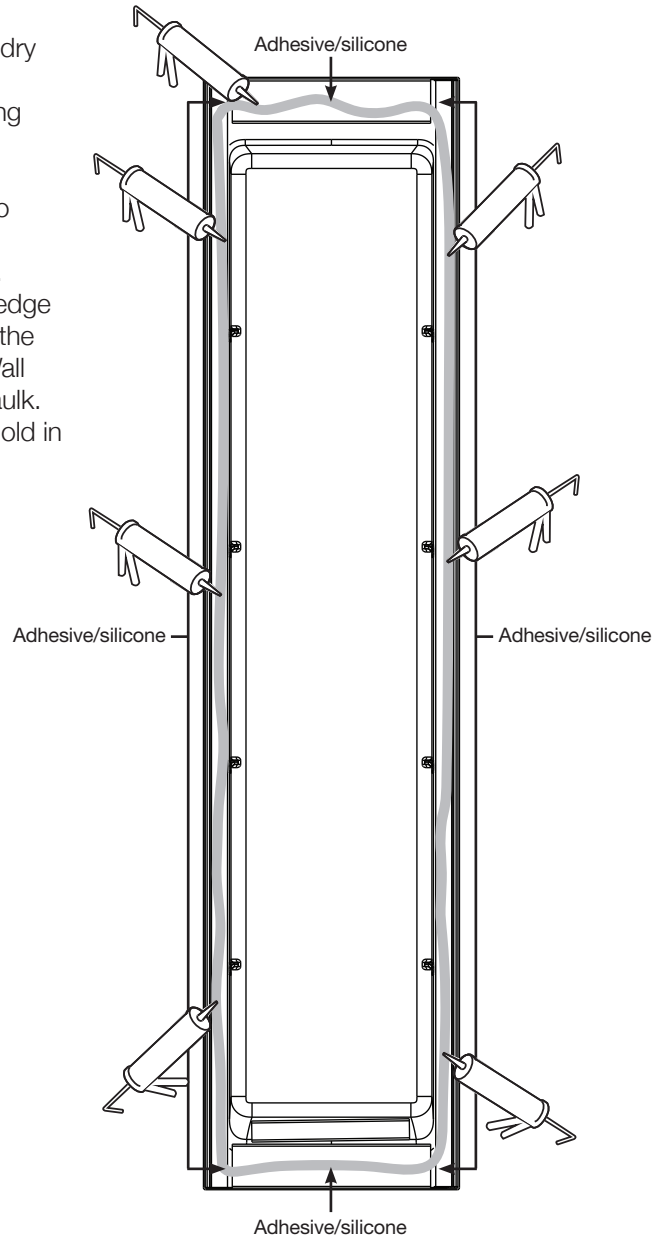

9

SHELF UNIT INSTALLATION

1. Apply white caulk/sealant around the perimeter of the Shelf Unit.

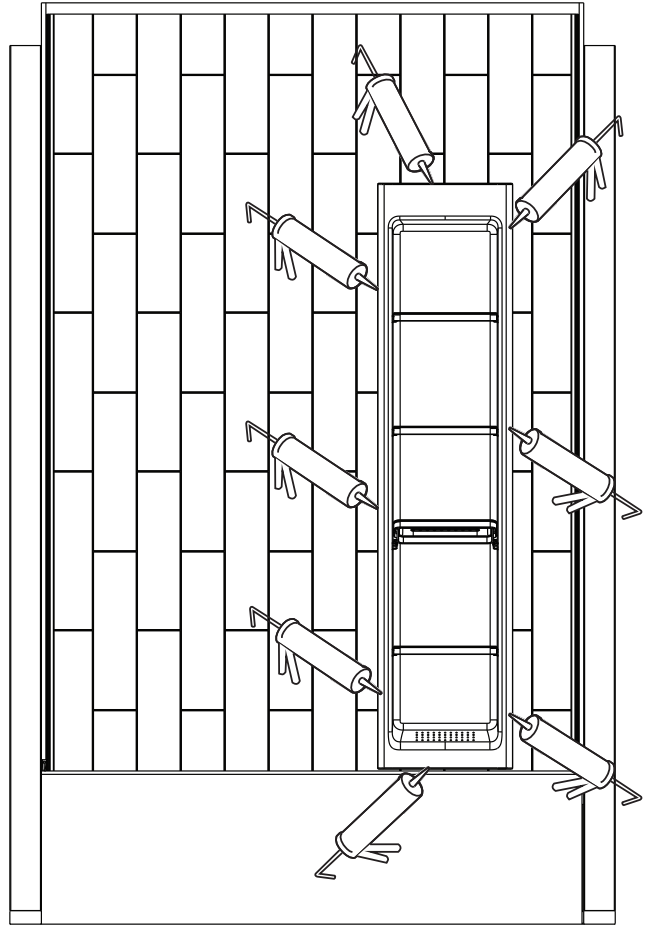

10

SHELF UNIT INSTALLATION

1. Follow steps 1 to 9 above when installing the Shelf Unit over a shower base.
NOTE: Positioning of the Shelf Unit vertically on the wall can be flexible according to personal preferences.

POST INSTALLATION CLEAN-UP

Remove all construction debris. Install any accessories, shelves or doors according to manufacturer's installation instructions.

AFTERCARE AND CLEANING

⚠ WARNING: Cleaning products with labels that say "not suitable for use with ABS, acrylic or polystyrene" SHOULD NOT BE USED. Read all labels carefully.

Clean shower walls with warm soapy water and soft sponge. For stubborn stains, use a 50/50 mix of isopropyl alcohol and water.

HARSH CHEMICALS SHOULD NEVER BE USED ON SHELF UNIT SURFACE. Clean after use with a mild liquid household detergent cleaner. **Do not use** Lestoil®, Lysol® Disinfectant (spray or concentrate), or Lysol® Basin, Tub and Tile Cleaner, Windex®, Mr. Clean®, Dow® Disinfectant Bathroom Cleaner, or cleaning products in aerosol cans.

Do not use wire brushes, knives or sharp objects to remove stains or other surface blemishes.

Abrasive cleaners or powders should not be used as they will dull the surface.

Do not allow nail polish remover, acetone, paint remover or other solvents to come into contact with the surface.

TOP SHELF DISHWASHER SAFE

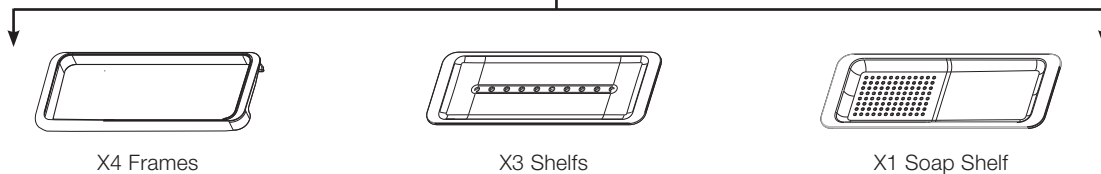

TELL US WHAT YOU THINK!

Please leave us a product review or story
at **AmericanStandard.com/reviews**

Find installation videos at
youtube.com/americanstandard

Register your warranty and sign up for an idea-filled newsletter at
AmericanStandard-us.com/support/warranty

PLEASE COMPLETE AMERICAN STANDARD WARRANTY REGISTRATION PROCESS AND SAVE THIS WARRANTY INFORMATION IMPORTANT:

Registration of the sink must be completed for this warranty to become effective. Your registration will make it easier to contact you in the event of a product recall.*

INSTRUCTIONS: Register your sink at www.americanstandard.com. Please save your proof of purchase (sale receipt). If you need assistance or do not have access to our website, please contact American Standard Customer Care at: (800) 442-1902. An American Standard representative will assist in completing the warranty registration.

*In California, your warranty rights remain intact even if you do not complete the registration process.



SHARE YOUR NEW PRODUCT!

Tag us **@american_standard** on Instagram
and show us how your new product looks.

≡ WANT MORE INFO?

For questions or help call us at **855-815-0004**,
or visit **AmericanStandard.com**

UNITED STATES

American Standard Brands
865 Centennial Ave.
Piscataway, New Jersey 08854
Attention: Director of Customer Care
For residents of the United States,
warranty information may also be
obtained by calling the following
toll free number: (855) 815-0004
www.AmericanStandard.com

CANADA

LIXIL Canada, Inc.
5900 Avebury Rd.
Mississauga, Ontario
Canada L5R 3M3
Toll Free: (800) 387-0369
AmericanStandard.ca/support/warranty

MEXICO

American Standard B&K Mexico
S. de R.L. de C.V.
Via Morelos #330
Col. Santa Clara
Ecatepec 55540 Edo. Mexico
Toll Free: 800-839-1200
AmericanStandard.com.mx/garantia

756256-100 EN (11/23)
7192000

11

PART OF **LIXIL**

American Standard