

TOTO

WASHLET G5A

Instruction Manual

If the water does not flow due to a power outage. (→Page 49)



MS7631CEMFG
(SN7631M)



Thank you for your recent purchase of this product.

Please read the enclosed information to ensure the safe use of your product.

Be sure to read this Instruction Manual before using your product and keep it in a safe place for future reference.

Table of Contents

Introduction

| | |
|---|----|
| Safety Precautions | 4 |
| Operational Precautions | 9 |
| Parts Names | 12 |
| Preparation | 14 |
| Using the Product for the First Time..... | 14 |

Operation

| | |
|--|-----------|
| Basic Operations | 16 |
| Mechanism of Auto Functions | 16 |
| Auto open / close | 16 |
| Deodorizer | 16 |
| Pre-mist | 16 |
| Auto power deodorizer | 16 |
| Auto flushing | 16 |
| Auto wand CLEAN | 16 |
| Soft light | 18 |
| Wand CLEAN LED | 18 |
| Using the Remote Control | 19 |
| Stop | 19 |
| Rear washing | 19 |
| Rear soft washing | 19 |
| Front washing | 19 |
| Warm air drying | 19 |
| Water pressure adjustment | 19 |
| Wand position adjustment | 19 |
| Pulsating washing | 19 |
| Oscillating washing | 19 |
| Wand CLEAN | 20 |
| Power dedorizer | 20 |
| Full flush | 20 |
| Light flush | 20 |
| Opening and closing the toilet lid | 20 |
| Opening and closing the toilet seat | 20 |
| Personal setting | 20 |
| Low battery warning mark | 20 |
| Power ON/OFF button | 21 |
| Wand cleaning | 21 |
| Warm water temperature | 21 |
| Toilet seat temperature | 21 |
| Drying air temperature | 21 |
| Auto energy saver / Auto energy saver+ | 21 |
| Timer energy saver | 21 |
| Auto open / close ON / OFF | 21 |
| Setting confirmation | 21 |

| | |
|---------------------------------------|-----------|
| Auto flushing ON / OFF | 21 |
| Temperature Adjustment..... | 22 |
| Warm water, Toilet seat, Drying | 22 |
| Changing Settings..... | 24 |
| Setting List | 24 |
| The energy saver features | 26 |
| How to Set..... | 28 |
| Auto energy saver..... | 28 |
| Auto energy saver+..... | 28 |
| Timer energy saver | 29 |
| Auto flushing..... | 29 |
| Auto flush delay | 30 |
| Auto flush lid closed..... | 30 |
| Auto open / close | 32 |
| Auto close delay | 32 |
| Auto open delay..... | 33 |
| Seat/lid | 33 |
| Auto wand CLEAN | 34 |
| Pre-mist | 34 |
| Deodorizer | 35 |
| Auto power deodorizer | 35 |
| Soft light | 36 |
| Night light | 36 |
| Anti freezing | 37 |
| Beep sound | 38 |
| Pressure/position setting | 38 |
| Personal setting | 39 |
| Registering Personal Settings..... | 39 |

Maintenance

| | |
|---|-----------|
| Maintenance | 40 |
| Before Maintenance | 40 |
| Power Plug | 40 |
| Top Unit | 41 |
| Bowl Unit | 42 |
| Gap between the Top Unit and Bowl Unit | 43 |
| Gap between the Top Unit and the Toilet Lid ... | 44 |
| Wand | 45 |
| Wand cleaning | 45 |
| Deodorizing Filter | 46 |
| Drain Plug With Water Supply Filter | 47 |
| Water Supply Filter (Bowl Unit) | 48 |

Reference

| | |
|--|-----------|
| What to Do? | 49 |
| If the water does not flow due to a power outage (when water failure hasn't occurred) | 49 |
| If the water does not flow due to a water service interruption | 51 |
| If you cannot operate with the remote control | 51 |
| Replacing the batteries | 52 |
| Freeze Damage Prevention | 52 |
| Long Periods of Disuse | 53 |
| How to drain the water | 53 |
| Resupplying the Water | 55 |
| Troubleshooting | 56 |
| Please check first | 56 |
| Rear Washing, Front Washing and Wand | 57 |
| Warm air drying | 58 |
| Flushing. | 58 |
| Toilet Seat and Toilet Lid (Auto open/close) ... | 60 |
| Toilet Seat and Toilet Lid | 62 |
| Auto flush lid closed | 63 |
| Energy Saver | 63 |
| Deodorizer | 64 |
| Lights | 64 |
| Others | 65 |
| Specifications | 67 |
| Limited Warranty | 68 |

Safety Precautions

IMPORTANT SAFEGUARDS

READ ALL INSTRUCTIONS BEFORE USING

Symbols and Meanings



WARNING

May result in death or serious injury.



CAUTION

May result in injury or property damage.



WARNING

Never disassemble, repair or alter.

Doing so may cause fire, electrical shock, overheating, short circuit or breakdown.

Do not use the product if a malfunction occurs.

In case of breakdown or other problem, be sure to cut off power by means such as unplugging the power plug.

Close the water shutoff valve to stop water supply.

Possible malfunctions:

- Water is leaking from a pipe or the top unit.
- The product is cracked or broken.
- The product makes a strange noise or emits a strange odor.
- The product emits smoke.
- The product is abnormally hot.
- The bowl unit is clogged.
- The toilet seat cushion is out of place.

Continued use after malfunction could cause a fire, electrical shock, heat, short circuit, injury or water damage.

Do not use other water than allowed by the laws and ordinances of the region of use. Only Use potable water.

Do not use seawater or recycled water.

Doing so may cause irritation to the skin and malfunction.

Keep cigarettes and other open flames away from the product.

Failure to do so may cause fire.

Refrain from sitting on the seat for long periods.

It may cause low-temperature burns.

To prevent the following persons from getting a moderate temperature burn during use, other person should turn off the toilet seat heater and set the dryer temperature to "Low".

- Young children, the aged and other users unable to set the temperature appropriately themselves.
- The ill, physically disabled and others who do not have freedom of movement.
- Those using any medicines that cause drowsiness (sleeping or cold medicine), those who have been drinking heavily, anyone severely fatigued and anyone else liable to fall asleep.

If the power cord is damaged, avoid danger by having the manufacturer's repair department or equivalent specialist replace it.

Turn the power OFF before maintenance or inspection.*1

Failure to do so may cause electrical shock or malfunction.

When leaking battery fluid adheres to your body or clothes, wash it away with clean water.

The fluid may damage your eyes or skin.

Do not stick a finger or anything else into the warm air outlet.

Do not place anything on the warm air outlet or drape clothes over it.

Doing so may cause burns, electrical shock or malfunction.

*1 How to turn off the product (→Page 15)

WARNING

Do not install the product on moving vehicles such as wheeled vehicles or boats.

Doing so may cause fire, electric shock, short circuit or malfunction.

The toilet seat, toilet lid, top unit, or other parts may come loose and fall off, resulting in injury.

Do not use any power supply other than the one specified.

AC 120 V, 60 Hz

Doing so may cause fire or excessive heat.

This is an electrical product. Do not install it anywhere water is likely to get on the product or anywhere with humidity high enough that water is likely to form on the surface of this product. When using the product in a bathroom, install a fan or ventilation port and ensure good air flow through the bathroom.

Failure to do so may cause fire or electrical shock.

Always connect the product to the cold water supply.

Connecting to hot water supply may result in burns and equipment damage.

Preliminary studies in females suggest that over-use of continuous spraying can increase the possibility of vaginal mucosa drying and potential reduction in desirable microbial organisms.

Although these studies have not been validated, please consult your healthcare provider for concerns regarding whether these circumstances may apply to you.

More importantly, if you are an individual suffering from any immune deficiency as a result of disease, chemotherapy, or other medical condition compromising the immune system you should consult your healthcare provider before use of this product.

Do not touch the connection of power cord with wet hands.

Doing so may cause electrical shock.

Do not allow any water or cleaning solution on the gaps between the top unit, top unit and bowl unit, or power supply connections.

Doing so may cause fire, electrical shock, heat or short circuit.

Doing so may cause the product to crack resulting in injury or water damage.

Do not touch the power source connection during thunderstorms.

Doing so may cause electrical shock.

Do not allow the water supply hose to touch the power source connection.

Doing so may cause condensation resulting in a fire, electrical shock, heat or a short.

Do not do anything that may damage the power cord or power source connection.

Do not strike, yank, twist, excessively bend, damage, alter, or heat the power cords.

Also, do not place anything heavy on, bind or pinch the power cords.

Using a damaged power cord may result in a fire, electrical shock, heat or short.

Confirm that a properly grounded outlet has been installed.

Failure to install a grounded outlet could cause electrical shock in the event of a malfunction.

*If there is no ground installed, ask the contractor who did the installation to install the ground.

Periodically remove dust and dirt from the power plug and make sure it is securely plugged into the wall outlet.

Failure to do so may cause fire, heat or short circuit.

Pull the power plug out from the outlet and wipe clean with a dry cloth.

Safety Precautions

WARNING

Do not use a loose or faulty electrical outlet.

Doing so may cause fire or short circuit.

Do no use any outlet beyond its specified rating.

Plugging too many plugs into the same outlet, for example using outlet splitters, can cause fire due to heat.

Insert the power plug securely into the outlet.

Failure to do so may cause fire, heat or short circuit.

To unplug, hold the power plug, not the power cord.

Do not unplug by pulling the power cord.

Pulling on the power cord may cause damage and result in fire or heat.

CAUTION

Do not use the product if the top unit is unstable.

Doing so may cause the top unit to come loose and fall, resulting in injury.

If the product is damaged, do not touch the damaged section.

Doing so may cause electrical shock or injury.
Replace it immediately.

Do not use the product while the top unit is lifted up by the cleaning lift.

When lowering the top unit by the cleaning lift, do not insert your fingers into the gap between the top unit and the bowl unit.

Do not apply strong force, mechanical shock, step on or stand on the toilet seat, toilet lid or top unit. Also do not place any heavy object on the toilet seat, toilet lid or top unit.

Doing so may cause cracking or cause the top unit to come loose and fall, resulting in injury.

Doing so may damage the product and cause injury or water damage.

When maintaining the plastic parts (top unit etc.) or the water supply hose, use a pH neutral kitchen detergent diluted with water. Do not use any of the following.

Toilet cleaner, household cleaner, benzene, paint thinner, powdered cleanser or nylon scrubbing brush.

These items may damage or crack the plastic and cause injury or malfunction.

These items could damage the water supply hose and cause a water leak.

To prevent a sudden water leak, do not remove the drain plug with water supply filter when the shutoff valve is open.

Doing so will cause water to spurt out.

(→Refer to Page 47 for instructions on cleaning the drain plug with water supply filter.)

CAUTION

Do not fold or crush the water supply hose; do not damage by cutting with a sharp object.

Doing so may cause water leaks.

Do not pour hot water into the toilet.

Doing so may result in damage to the toilet, injury or water damage.

Keep the bowl filled with water.

Failure to do so may cause sewer gas, chlorine gas, or hydrogen sulfide to corrode facilities and equipment.

Do not flush anything other than bodily waste and toilet paper. Also, do not flush too much toilet paper. Do not flush the bowl unit if it is clogged.

Doing so may clog the toilet, causing waste water overflow, and water damage.

Always flush, even after just urinating.

Failure to do so may clog the toilet, causing waste water overflow and water damage or inadequate flushing of the bowl unit.

Wipe condensation on the bowl unit, tank, water supply pipe and shutoff valve with a dry cloth.

Condensation may cause staining and corrosion of the floor. Ventilate the restroom to prevent condensation.

Wipe any urine, condensation, cleaner, water, etc. that has gotten on the floor with a well-wrung mop or cloth.

Failure to do so may cause staining and corrosion of the floor.

If a water leak should occur, always close the shutoff valve.

When the ambient temperature is likely to drop to 32 °F (0 °C) or lower, prevent damage to the pipes and hoses due to freezing.

Frozen water pipes could cause the top unit and the pipes to break, resulting in a water leak.

Regulate the room temperature to prevent the pipes and hoses from freezing during cold months.

When not using the product for a long time, close the shutoff valve, drain the water from the top unit and water supply hose, and then turn the power OFF.*1

When using the product again, allow the product to refill with water first. Otherwise, the water in the tank might become contaminated and cause skin inflammation or other problems. (*→Refer to Page 55 for instructions on replenishing the water.*)

Leaving the power on may cause fire or heat.

When installing the drain plug with water supply filter, make sure that it is securely tightened in its proper position.

Failure to securely tighten it may cause a water leak.

If the bowl is clogged, turn the power OFF*1 and remove the clog.

If the auto flush were allowed to function, it would make the wastewater in the bowl unit overflow and may result in water damage.

Use commercially available tools that are made for unclogging the bowl unit to remove the clogging.

Make sure of the plus and minus signs on the batteries before inserting them.

Remove depleted batteries immediately.

When replacing the batteries:

- Replace both batteries with new ones.
- Use the same brand for both new batteries (any brand available).

Failure to do so may cause the batteries to leak fluid, generate heat, rupture, or ignite.

When the product is supposed not to be used for long time, remove the batteries from the remote control.

Failure to do so may cause the batteries to leak fluid.

1 How to turn off the product (→Page 15*)

Safety Precautions

DANGER

To reduce the risk of electrocution:

1. Do not use while bathing.
2. Do not place or store the product where it can fall or be pulled into a tub or sink.
3. Do not place in or drop into water or other liquid.
4. Do not reach for the product when it has fallen into water. Unplug it immediately.

WARNING

To reduce the risk of burns, electrocution, fire or injury to persons:

1. Close supervision is necessary when this product is used by, on, or near children or invalids.
2. Use this product only for its intended use as described in this manual. Do not use attachments not recommended by the manufacturer.
3. Never operate this product if it has a damaged cord or plug, is not working properly, has been dropped or damaged, or has been dropped in water. Return the product to a service center for examination and repair.
4. Keep the cord away from heated surfaces.
5. Never block the air openings on the product or place it on a soft surface, such as a bed or couch, where the air openings may be blocked. Keep the air openings free of lint, hair, and other similar items.
6. Never use while sleepy or drowsy.
7. Never drop or insert any object into any opening or hose.
8. Do not use outdoors. Do not operate where aerosol (spray) products are being used or where oxygen is being administered.
9. Connect this product to a properly grounded outlet only.
See "Grounding Instructions" in below.
10. The tank should be filled with water only.

- Servicing should be performed by an authorized service representative.
- This product is for household use.

Grounding Instructions

This product should be grounded. In the event of an electrical short circuit, grounding reduces the risk of electric shock by providing an escape wire for the electrical current.

This product is equipped with a cord having a grounding wire with a grounding plug.

The plug must be plugged into an outlet that is properly installed and grounded.

 **DANGER** - Improper use of the grounding plug can result in a risk of electric shock.

If repair or replacement of the cord or plug is necessary, do not connect the grounding wire to either flat-head terminal.

Check with a qualified electrician or serviceman if the grounding wire instructions are not completely understood, or if in doubt as to whether the product is properly grounded.

SAVE THESE INSTRUCTIONS

Operational Precautions

For prevention of malfunctions

Do not block the body sensor or the remote control transmitter or receiver.

About the body sensors

Two types of body sensors are used.

Body sensor A detects changes in heat.

Detection may be difficult when the room temperature exceeds 86 °F (30 °C), such as in the summertime.

When sunlight is directly on the sensor area or a heater is used in the bathroom, the sensor may detect incorrectly due to the heat, resulting in the automatic operation of functions such as auto lid opening and closing.

When the bathroom door is open, the sensor may detect people who pass to the front or side of the toilet.

Body sensor B detects when someone stands in front of the toilet bowl.

Body sensor B emits an infrared beam as shown in the figure. When someone moves into the line of this infrared beam, the sensor detects the person.

Detection by the sensor may be difficult when the toilet is used by someone small, such as a child.

Body sensor A
(Detects changes
in heat)



Body sensor B
(Detects when
someone stands near)



About the seat switch

When you sit on the toilet seat, the seat switch turns ON, enabling you to use various features. (A click sound is heard when the seat switch is ACTIVATED.)

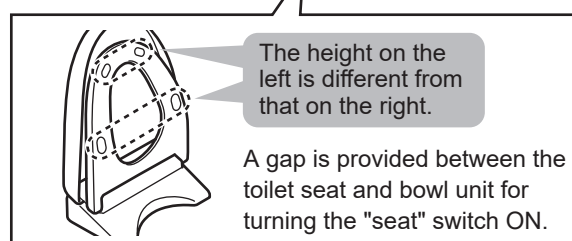
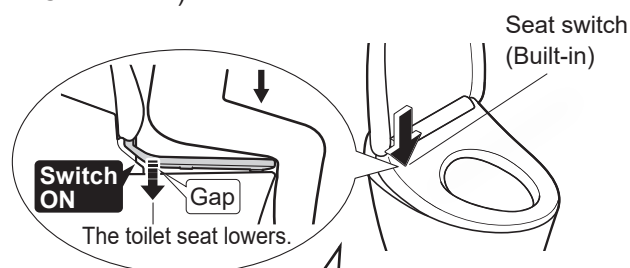

Sit back on the toilet seat.

The seat switch will not turn on unless you sit on the seat properly.



Note: When a child uses the product, the seat switch may not be ACTIVATED by their light body weight. Since the toilet seat is designed to move up and down, a clearance is provided between the toilet seat cushion and the bowl unit.

Operational Precautions

For prevention of damage

Wipe plastic areas such as the top unit and remote control with a soft cloth tightly wrung out with water.

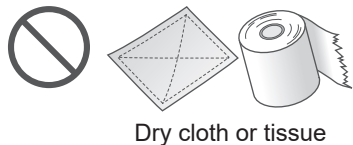

Dry cloth or tissue

Do not lean against the toilet lid.



For prevention of malfunctions and failures

Turn the power OFF if there is a risk for lightning strike.*1

A toilet seat cover or a toilet lid cover cannot be used. The body sensor and seat switch may not function properly. Additionally, the toilet seat and lid may not open or close properly.



Covers

Do not urinate on the top unit, toilet seat or wand. Doing so may cause a failure or discoloration.

Do not apply strong forces to the control panel of the remote control.

When using a toilet cleaner to clean the toilet, rinse it off within 3 minutes and leave the toilet seat and toilet lid open.

If vapor from a toilet cleaner enters the top unit, it may cause a malfunction.

► Wipe off any cleaner that remains on the bowl unit.

Note: If "Auto flush lid closed" (→ Pages 30, 31) is turned ON and you use the remote control to flush the bowl unit, the toilet seat and lid close before flushing the bowl unit.

After the bowl unit has been flushed, open the toilet seat and lid.

Do not use the product with the toilet lid removed.

Do not expose to direct sunlight.

Doing so may cause changes in color, irregular heated seat temperature or remote control malfunction. It may also cause product malfunction due to the change in temperature.

Use radios, etc. away from the product.

The product could cause interference with the radio signal.

If you use a booster seat for infants or a soft highchair, remove it after use.

Keeping it installed may prevent some of the functions from being used.

Do not apply force to the remote control.

This cause malfunction.

► To prevent the remote control from being dropped, set it in the hanger when you are not using it. Be careful not to expose it to water.

Do not place anything on the toilet seat and lid, and do not press them with hands.

Failure to do so may turn on the seat switch, causing the floor to get wet if buttons on the remote control are touched and warm water comes out from the wand.

*1 How to turn off the product (→Page 15)

Parts Names

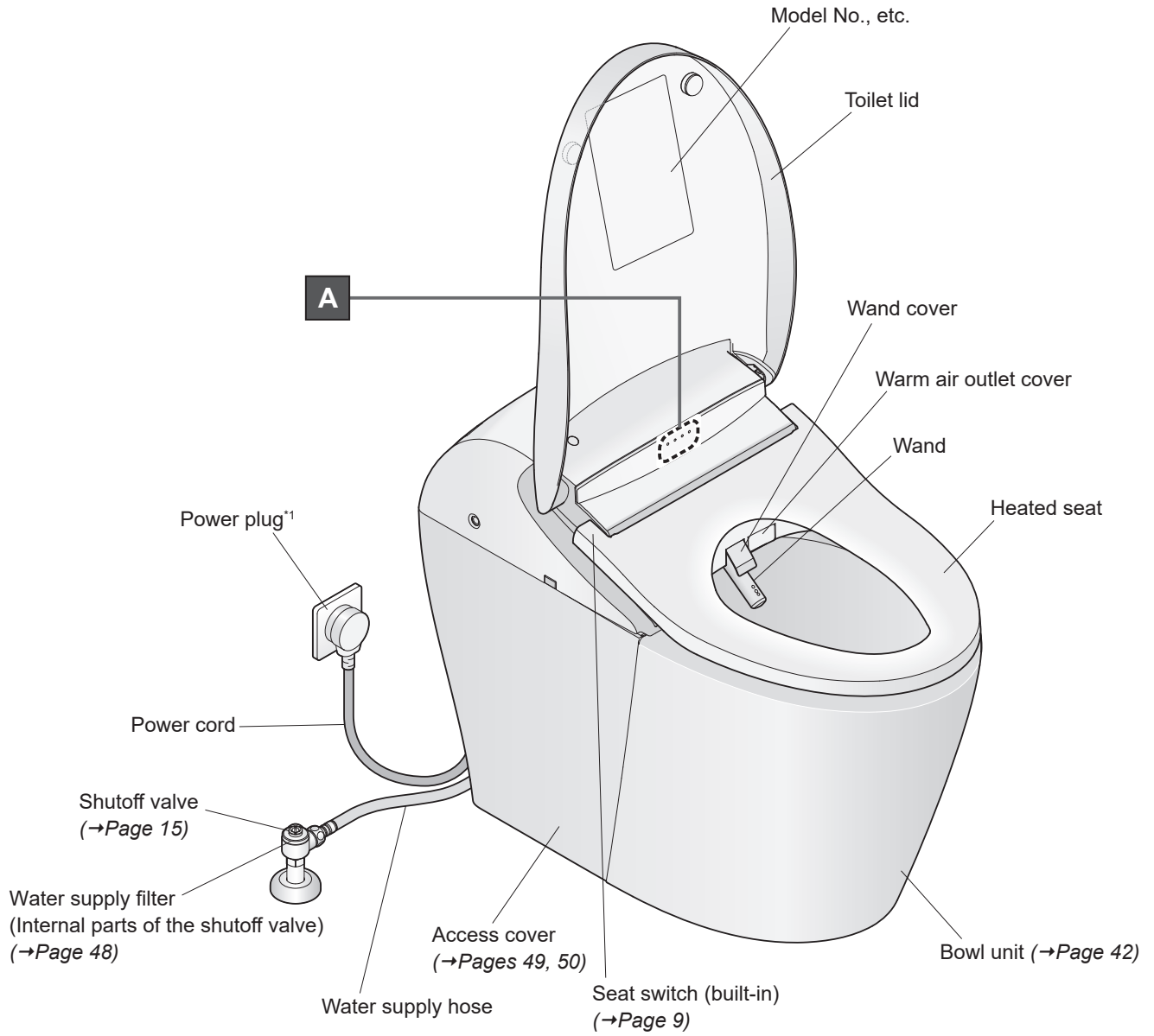

A: Main display

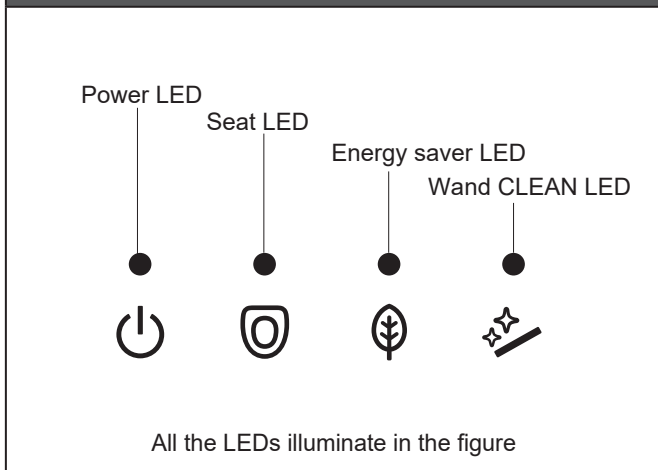

*1 The shape of the power plug may vary.

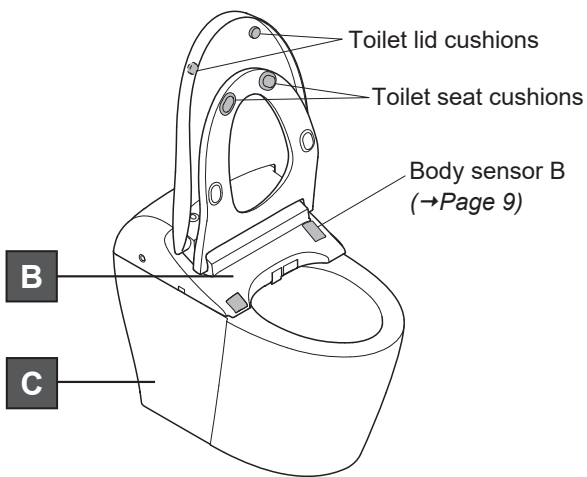

Body sensor A
(→Page 9)

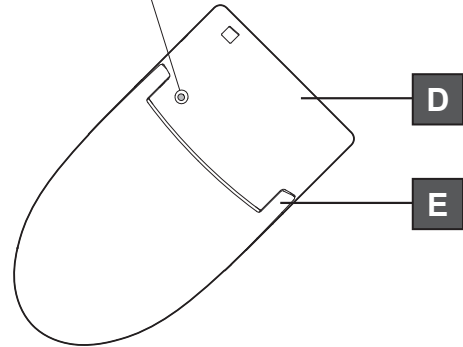

B: Front side of the top unit

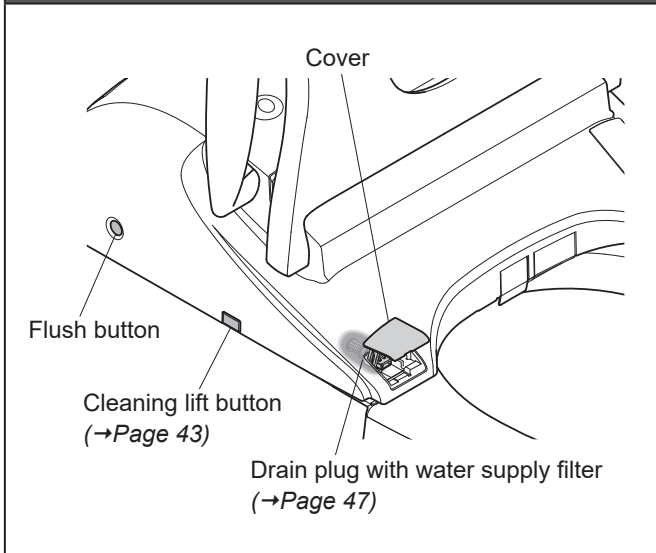

C: Left side of the bowl unit

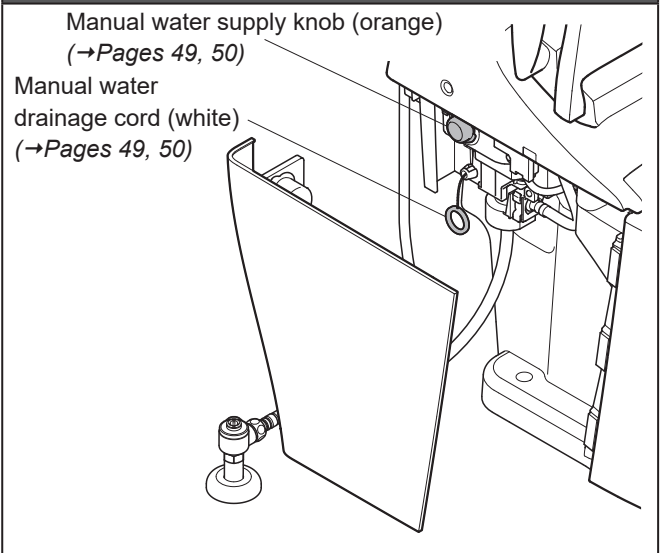

D: Rear side of the top unit

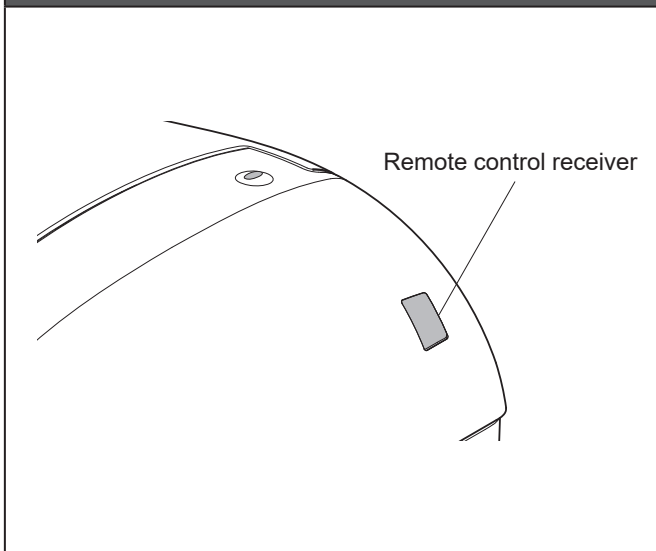

E: Right side of the top unit

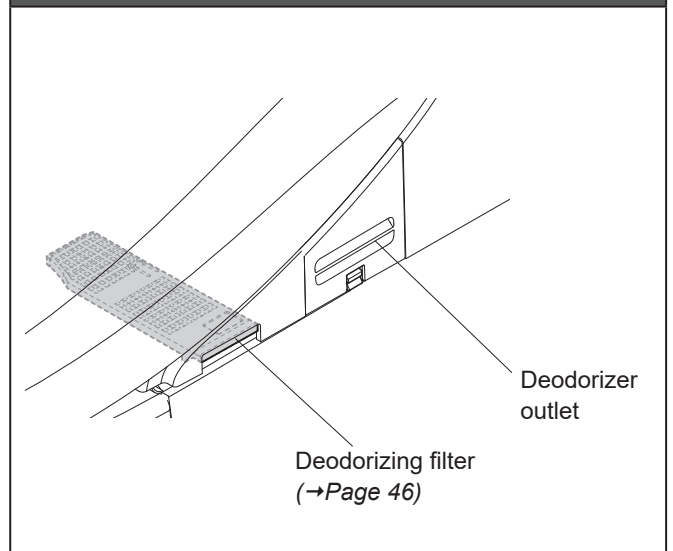

Preparation

Using the Product for the First Time

1. Insert the battery

1.1 Remove the remote control from the hanger.

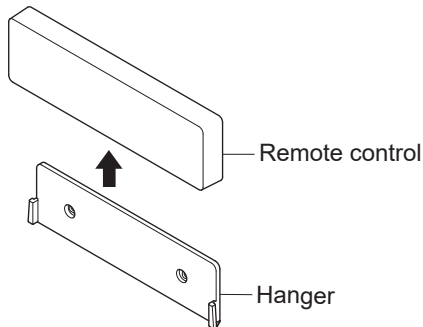

1.2 Open the battery cover and insert two AAA batteries. After inserting batteries, close the battery cover.

Remote control back side

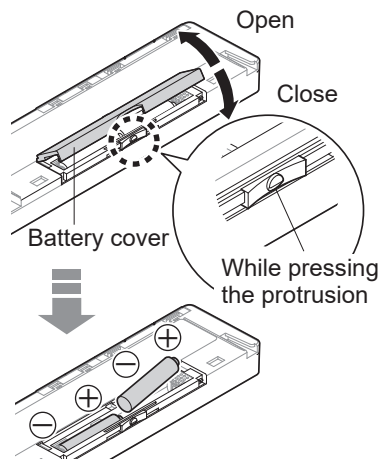

- ▶ When batteries are properly loaded, all the LEDs on the remote control light up for about 2 sec.

1.3 Mount the remote control in the hanger.

About the batterie

Use dry cell, alkaline batteries.

Be sure to follow "Safety Precautions" to prevent the batteries from rupturing or leaking fluid. (→Pages 4, 7)

2. Turn on the power

2.1 Insert the power plug.

- ▶ The wand extends and then retracts.

2.2 Check the "Power" LED illuminates.

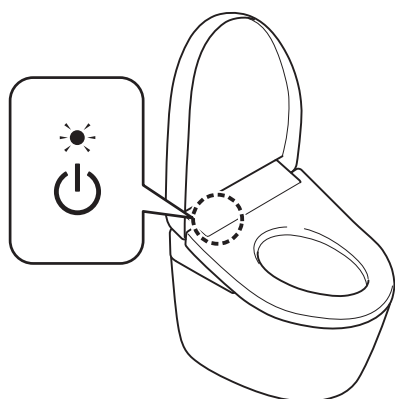

If the light is off

Switch "Power" to "ON" using the remote control.

-  Press "Power ON/OFF" button about 3 seconds or longer.

To turn the power "OFF"

Unplug the power plug.

- ▶ The "Power" LED is unilluminated.

3. Open the shutoff valve

3.1 Fully open the shutoff valve.

Opening / closing tool (accessory)*¹
or flat-head screwdriver

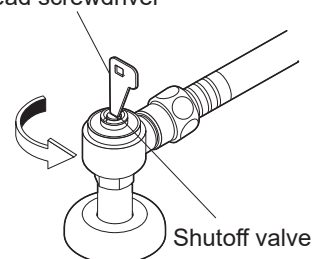

*1 Use the supplied opening/closing tool.

Basic Operations

Mechanism of Auto Functions

"EWATER+" is used automatically to clean the wand.

1. As you approach



Auto open / close

Auto open / close

The toilet lid opens

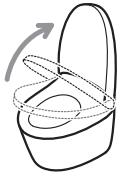

When the toilet is used in standing position

Open the toilet seat with the remote control.

2. As you sit^{*1}



Deodorizer
Pre-mist

Deodorizer

Starts the deodorizer



Removing odors inside the bowl unit.

Note: Deodorizing filter needs regular maintenance. (→Page 46)

Pre-mist

Pre-mist

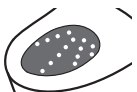

A mist is automatically sprayed inside the bowl unit to make it more difficult for dirt to adhere.

3. As you stand up



Auto power deodorizer
Auto flushing
Auto wand CLEAN

Auto power deodorizer

After about 10 seconds

Starts the auto power deodorizer



It stops about 60 seconds after you stand up from the toilet seat

Auto flushing

After about 10 seconds

The toilet flushes^{*2}



Note: The flushing varies depending on how long you sit on the toilet seat.

- Performs a light flush if the time is about 6 to 30 seconds.
- Performs a full flush if the time is about 30 seconds or longer.

Auto wand CLEAN

Only when the washing functions are used.

After about 25 seconds

The wand extends to clean with the "EWATER+" that comes out of the base^{*3}



Note: "EWATER+" can also be used by pressing the remote control button. (→Page 20 "Wand CLEAN")

4. As you move away

(When you move away)



Auto flushing
Auto open / close

Operation under the default settings is described in "Mechanism of Auto Functions".

These mechanisms be changed.
(→Pages 24–39 "Changing Settings")

What is meant by "EWATER+" ?

"EWATER+" helps the self-cleaning wand feature work effectively and by preventing the accumulation of dirt that can cause stains.

- "EWATER+" is generated from chemicals already present in potable water.
- "EWATER+" helps to minimize dirty surfaces, but does not make cleaning unnecessary.
- The effect of rinsing with "EWATER+" can vary depending on the frequency of toilet use and other conditions.

Auto open / close

After about 90 seconds.

The toilet lid closes*²

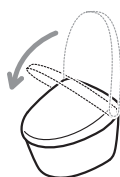

When the toilet is used in standing position

Auto flushing

About 3 seconds after the user has moved about 1 ft (about 30 cm) away from the bowl unit

The toilet flushes*²



Performs a light flush.

Auto open / close

About 90 seconds after the user has moved about 1 ft (about 30 cm) away from the bowl unit

The toilet lid and toilet seat close*²

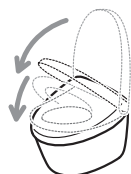

*1 Water comes out from the area around the wand for several seconds while water is warmed up.

*2 You can change to the setting that closes the toilet lid before flushing the bowl unit. (→Pages 30, 31)

*3 When the washing functions (Rear washing and Front washing etc.) have not been used in 8 hours, the wand is cleaned automatically. (Water comes out from around the wand.)

*4 The toilet lid and seat will close automatically 90 seconds after a person is no longer detected, this includes briefly sitting on the seat or standing in front of the toilet for a short time.

Basic Operations

Mechanism of Auto Functions

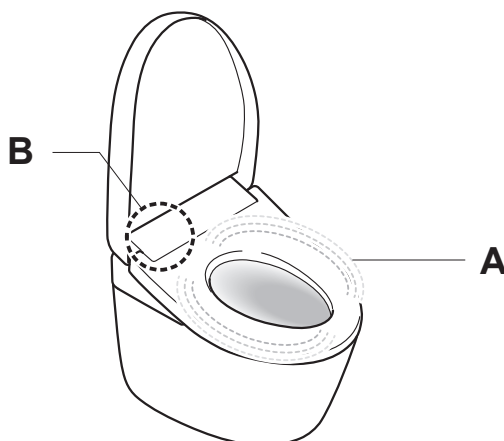

A Soft light

Lighting up the inside of the bathroom with a soft light.

It lights up as you approach the bowl unit and goes off after you move away from the unit and a certain time has passed.

Note: You can turn "Soft light" ON or OFF.
(→Page 36)

Night light

You can change "Soft light" to "Night mode", a lighting mode suitable for night. (→Page 36)

B Wand CLEAN LED

During Wand CLEAN



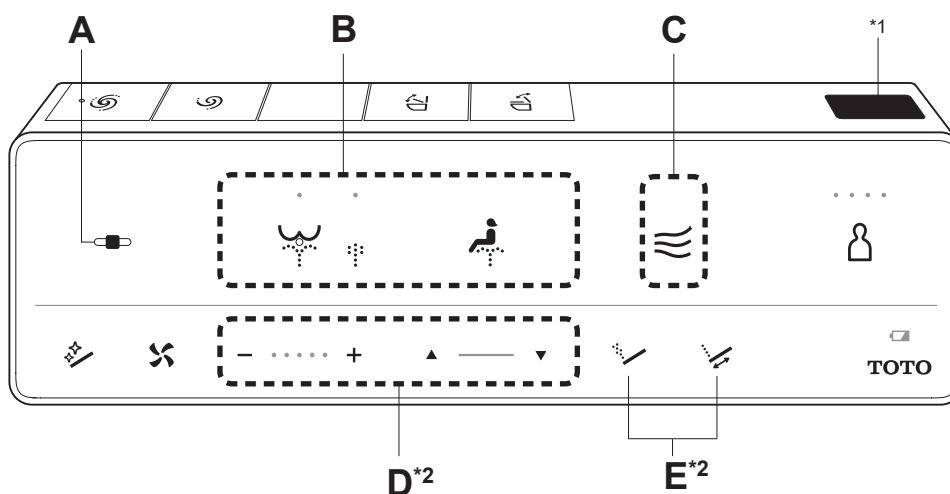

Using the Remote Control







Operate the controls on the remote control; a beep sounds when the top unit receives the signal.

A  **Stop**
Stops the B or C operation.

B  **Rear washing**
Washes your rear.





 **Rear soft washing**
Washes your rear with mild water pressure.

The setting changes between  and  each time the  is pressed.

 **Front washing**
Serves as a bidet for ladies.

C  **Warm air drying**
Dries your rear.

D  **Water pressure adjustment**
You can adjust the water pressure to one of five levels. [-] Softer, [+] Stronger
After you press the "Water pressure adjustment" button, the set position will light for 10 seconds.

  **Wand position adjustment**
You can adjust the washing position to 5 different points between the front and the rear, using the [] and [] buttons.

Once use of the remote control is finished, the settings will return to the initial setting (3rd position) after a while, not exceeding a maximum of 5 minutes.

If you do not want to return to 3rd position (→Page 38)

Note: Sitting back on the toilet seat makes it easier to adjust the wand position and to reduce splashing.

E  **Pulsating washing**
Washes with the water pressure pulsating between soft and strong.

 **Oscillating washing**
The wand moves back and forth to washes your rear thoroughly.

Note: Sitting back on the toilet seat makes it easier to adjust the wand position and to reduce splashing.

*1 Remote control transmitter

*2 While using B, these buttons and their functions can be operated.



Basic Operations

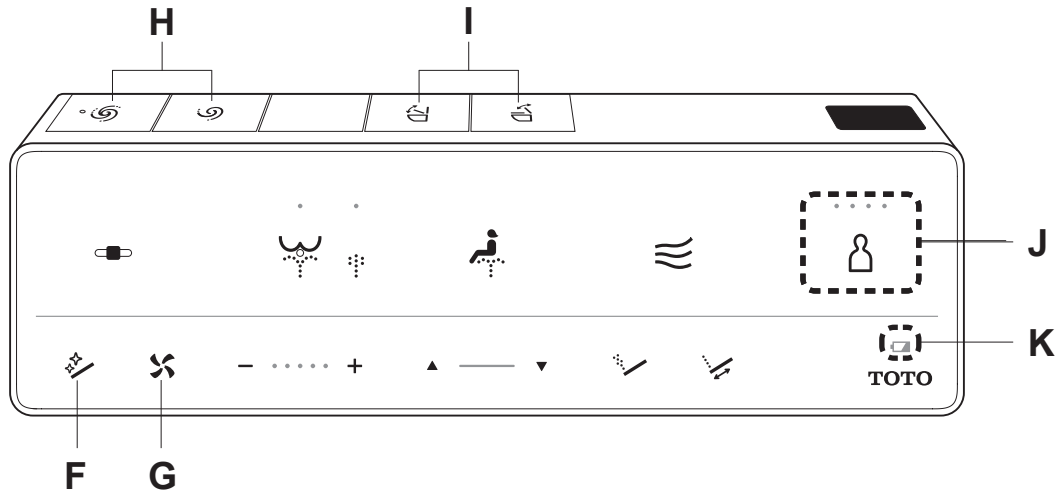

Using the Remote Control (Continued)



F  **Wand CLEAN**
 Cleans the wand with "EWATER+"*1
 After wand cleaning, water comes out from around the wand.
Note: This function will operate automatically after using the washing functions (Rear washing, Front washing, etc.). (→Pages 16, 34 "Auto wand CLEAN")
Note: To clean the wand with it extended. (→Page 45 "Wand cleaning")

G  **Power deodorizer**
 Press the button to increase suction power and remove odor.
 Cannot be used unless you are seated on the toilet seat.
 Stops automatically in 60 seconds if left running.

H  **Full flush*2**
 Performs a full flush.
 Up to 33 ft (10 m) of toilet paper (single)
 **Light flush*2**
 Performs a light flush.
 Up to 10 ft (3 m) of toilet paper (single)

I  **Opening and closing the toilet lid**
 Opens and closes the toilet lid.
 **Opening and closing the toilet seat**
 Opens and closes the toilet seat.

J  **Personal setting**
 Up to four people can register their preferred "Water pressure", "Wand position" and "Warm water temperature" settings. (→Page 39)
To use
 1) Press the button to turn on the LED for the location of your setting.

- ○ ○ ○ Register1
- ● ○ ○ Register2
- ● ● ○ Register3
- ● ● ● Register4

 2) Press the wash button you want to use ("Rear washing", etc.)

K  **Low battery warning mark**
 (→Page 51)

*1 What is meant by "EWATER+"? (→Page 17)

*2 You can change to the setting that closes the toilet lid before flushing the bowl unit. (→Pages 30, 31)





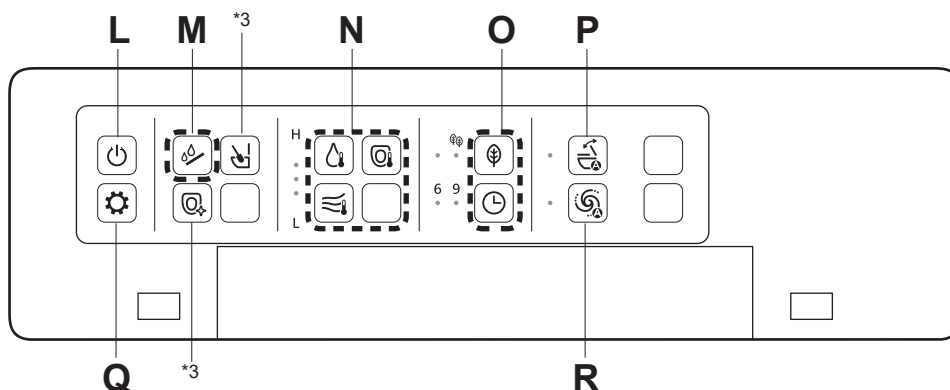





Remote control back side

How to remove the remote control (→Page 14)



Operate the controls on the remote control; a beep sounds when the top unit receives the signal.

This section is an overview of the settings that can be configured with the remote control. See the corresponding pages for the detailed descriptions.

| | | |
|---|--|--|
| <p>L</p>  | <p>"Power ON/OFF" button Press and hold for 3 seconds or longer to turn washlet operation on/off. (→Page 15 2-2.2)</p> | <p>O</p>  <p>Auto energy saver / Auto energy saver+</p>  <p>Timer energy saver Saving energy (→Pages 28, 29)</p> |
| <p>M</p>  | <p>Wand cleaning (→Page 45) <i>Note: It cannot be used when the wand is out or when you are sitting on the toilet seat.</i></p> | <p>P</p>  <p>Auto open/close ON / OFF Changing Settings (→Page 32)</p> |
| <p>N</p>  <p>Warm water temperature</p>  <p>Toilet seat temperature</p>  <p>Drying air temperature Adjust temperatures (→Pages 22, 23)</p> | | <p>Q</p>  <p>Setting confirmation The current setting can be discerned from the LEDs.</p> <hr/> <p>R</p>  <p>Auto flushing ON / OFF Changing Settings (→Page 29)</p> |

*3 The button is not used with this product, so pressing it does not perform operations.

Temperature Adjustment

Warm Water, Toilet Seat, Drying

Three different temperature levels from high to low and "OFF" can be set.

Remote control back side

How to remove the remote control (→Page 14)

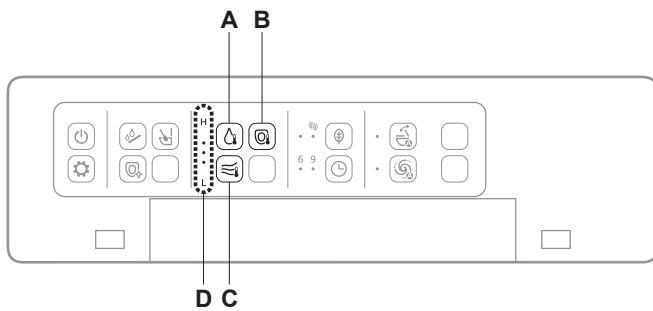

- A Warm water temperature button**
(When you want to adjust the warm water temperature)
- B Toilet seat temperature button**
(When you want to adjust the toilet seat temperature)
- C Drying air temperature button**
(When you want to adjust the drying air temperature)
- D Displaying the temperature level of the pressed button**

Adjusting the temperature

- 1.** Remove the remote control from the hanger.
(→Page 14)
- 2.** Choose and press the button of the temperature that you want to set from the ("Toilet seat temperature" button), ("Warm water temperature" button) and (Drying air temperature button).

▶ The current temperature level appears.

- 3.** Press the button selected in step 2 repeatedly until a desired temperature level illuminates.

▶ The setting changes each time the button is pressed once

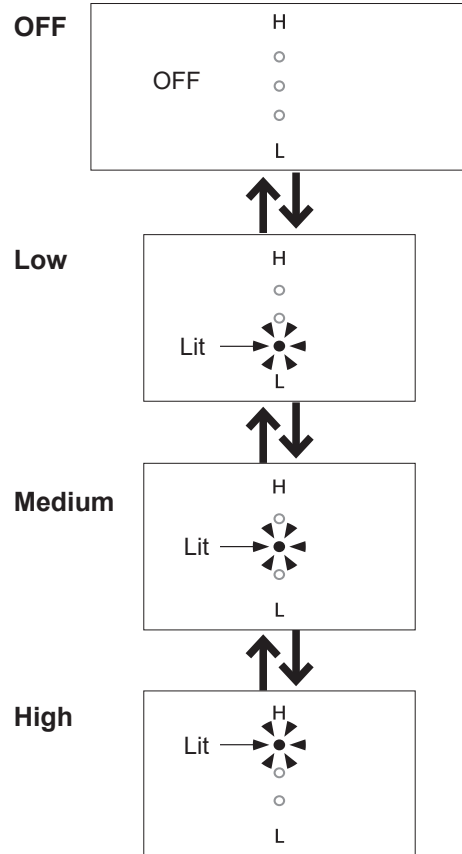

Settings complete

▶ When seat temperature is set, the SEAT LED illuminates.





Note: The "Drying" cannot be turned "OFF".
If the button is not pressed for about 10 seconds, the "Temperature adjustment" LED will go off, but the setting will be retained.
If the "Temperature adjustment" LED goes out before the setting is completed, start all over again at step 2.

- 4.** Mount the remote control in the hanger.
(→Page 14)

If adjusting the temperature does not warm up the toilet seat.

▶ Is the energy saver set to "ON"? (→Pages 26, 27)

To turn the warm water temperature*1 and toilet seat temperature "OFF"

1. Remove the remote control from the hanger. (→Page 14)
2. Select a temperature button you want to turn "OFF" from  ("Toilet seat temperature" button),  ("Warm water temperature" button) and press it.
 - ▶ The current temperature level appears.

3. Press the button selected in step 2 repeatedly until the temperature level is set to "OFF".

▶ The setting changes each time the button is pressed once

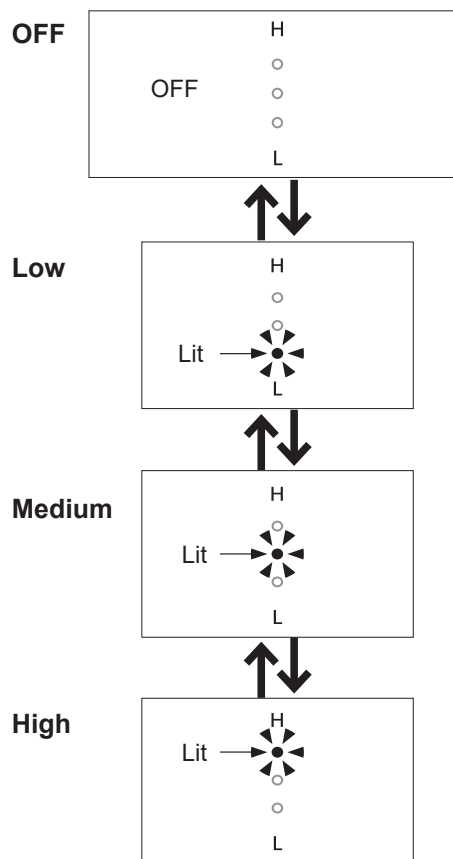

Settings complete

▶ When seat temperature is OFF, the SEAT LED is unilluminated.



Note: The "Drying" cannot be turned "OFF".

4. Mount the remote control in the hanger. (→Page 14)

*1 To prevent condensation, the water temperature does not drop below 68 °F (20 °C) even when set to "OFF".

Changing Settings

Setting List

| Setting Types | Available Settings Bold: Initial settings |
|--|--|
| Auto energy saver (→Page 28) | ON/ OFF |
| Auto energy saver+ (→Page 28) | ON/ OFF |
| Timer energy saver (→Page 29) | 6H/9H/ OFF |
| Auto flushing (→Page 29) | ON /OFF |
| Auto flush delay (→Page 30) | SET1/ SET2 /SET3 |
| Auto flush lid closed (→Page 30) | ON/ OFF |
| Auto open / close (→Page 32) | ON /OFF |
| Auto close delay (→Page 32) | SET1/ SET2 |
| Auto open delay (→Page 33) | SET1 /SET2/SET3 |
| Seat/lid (→Page 33) | Lid /Seat·Lid |
| Auto wand CLEAN (→Page 34) | ON /OFF |
| Pre-mist (→Page 34) | ON /OFF |
| Deodorizer (→Page 35) | ON /OFF |
| Auto power deodorizer (→Page 35) | ON /OFF |
| Soft light (→Page 36) | ON /OFF |
| Night light (→Page 36) | ON/ STANDBY /TIMER |
| Anti freezing (→Page 37) | ON/ OFF |
| Beep sound (→Page 38) | ON /OFF*1 |
| Pressure/position setting (→Page 38) | ON/ OFF |
| Personal setting (→Page 39) | ON /OFF |
| Registering Personal Settings (→Page 39) | Register 1/Register 2/Register 3/Register 4 |

*1 The beep sounds when settings are being changed, even if the beep noise is turned off. (except for "Pressure/position setting" or "Personal setting")

Setting with buttons on the front of the remote control.

Press the button indicated in step 1 for approximately 10 seconds or longer to enter setting mode.

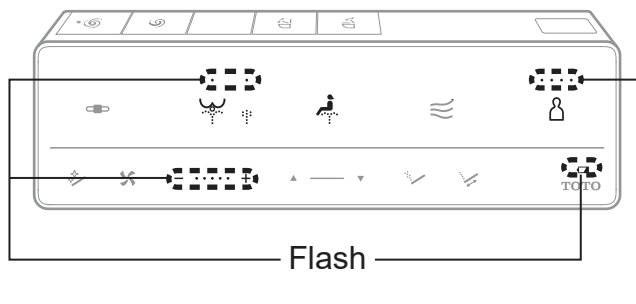

Check

Press "Stop" button about 10 seconds or longer.

and **+** Press "Stop" button and "Water pressure adjustment +" button about 10 seconds or longer.

Note: During setting, if the next button is not pressed within about 60 seconds, the light will stop flashing. If you fail to complete the setting, redo from the step 1.

Setting with buttons on the back of the remote control.

Remote control back side

How to remove the remote control (→Page 14)

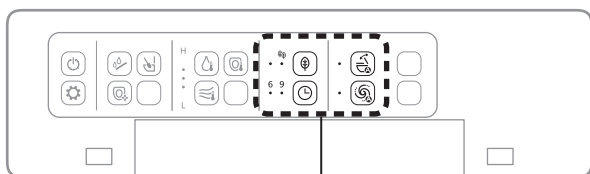

Use the LED to check settings.

▶ **Setting buttons (→Pages 26–39)**

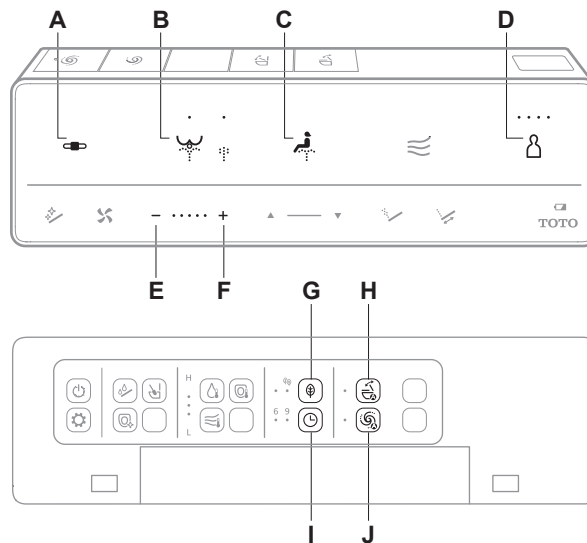

- A** Stop button
- B** Rear washing button
- C** Front washing button
- D** Personal setting button
- E** Water pressure adjustment - button
- F** Water pressure adjustment + button
- G** Auto energy saver button
- H** Auto open / close button
- I** Timer energy saver button
- J** Auto flushing button

Changing Settings

The energy saver features

"Auto energy saver", "Auto energy saver+" or "Timer energy saver" can be selected.

To save energy, the temperature of the toilet seat becomes low (or "OFF").

Note: Even if the energy saver is activated (with the toilet seat heater set to Low or OFF), the toilet seat will be temporarily heated when you sit on it. (To reach the set temperature, the toilet seat takes about 15 minutes.) The LED indication on the main display returns to the state for when the energy saver is on.

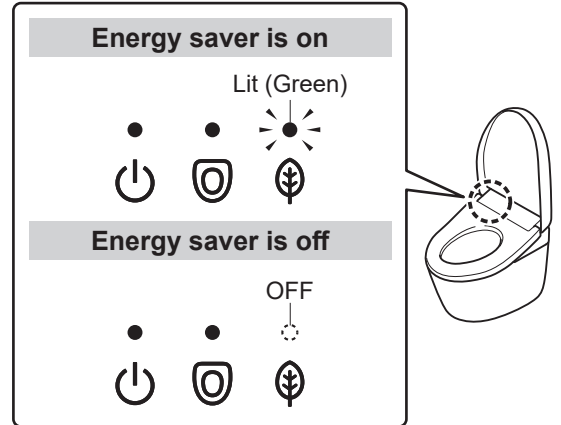

Auto energy saver

You want the product to save energy automatically

The product detects time periods with infrequent use and lowers the toilet seat temperature automatically.

It takes about 10 days for the product to determine the periods when it is used relatively less frequently.

When energy saver is in operation

Main display

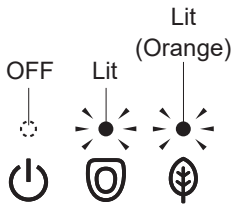

Toilet seat heater



Auto energy saver+

You want to save more energy

In addition to the "Auto energy saver" feature, it automatically turns off the toilet seat heater during time periods when the toilet is not used.

When energy saver is in operation

Main display

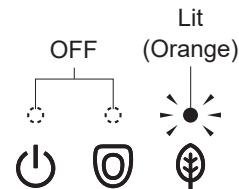

Toilet seat heater

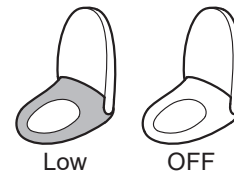

Example

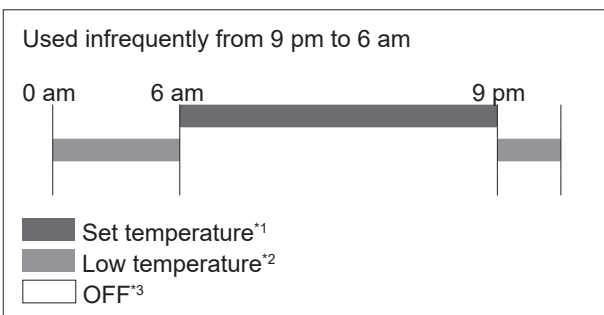

Example

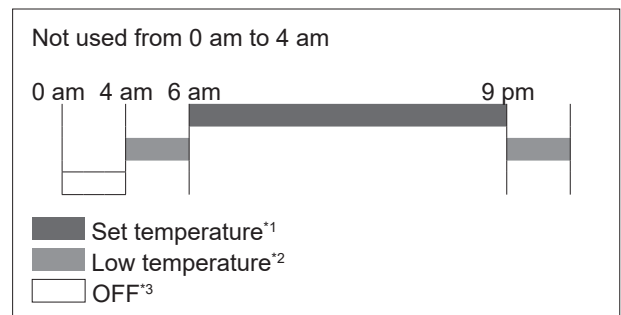

*1 The toilet seat temperature settings on pages 22, 23.

*2 The time period when the toilet seat heater is set to a "Low".

*3 The time period when the toilet seat heater is set to a "OFF".

Timer energy saver

You want to save energy only for a preset duration of time. (6 hours, 9 hours)

Once the time is set, the toilet seat heater turns off automatically during the set time period every day.

When energy saver is in operation

Main display

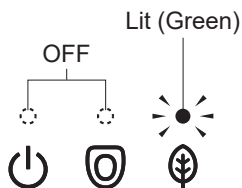

Toilet seat heater



Example

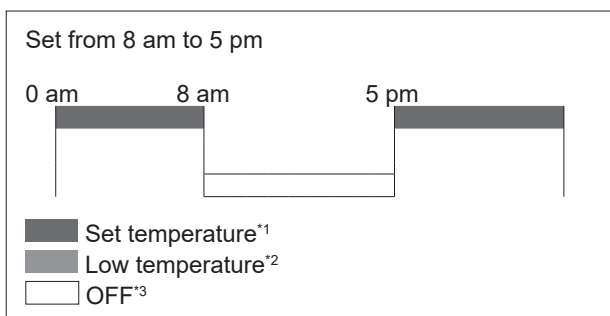

Timer energy saver and Auto energy saver / Auto energy saver+

You want to save the maximum amount of energy possible?

When both "Timer energy saver" and "Auto energy saver / Auto energy saver+" are set, "Auto energy saver / Auto energy saver+" operates when "Timer energy saver" is not operating.

When energy saver is in operation

Main display

During "Auto energy saver / Auto energy saver+":

- ▶ Same LED indication as "Auto energy saver / Auto energy saver+" (→Page 26)

During "Timer energy saver":

- ▶ Same LED indication as "Timer energy saver" (→See the description on the left)

Toilet seat heater

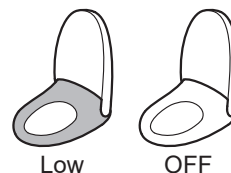

Example

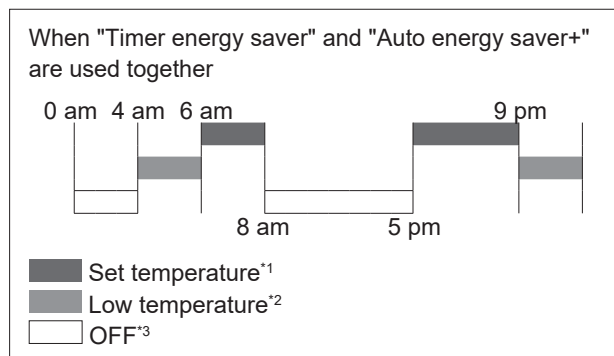

Changing Settings

How to Set

Auto energy saver

1. 

Press "Auto energy saver" button.

► The setting changes each time the button is pressed once.

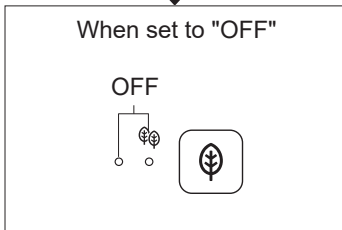
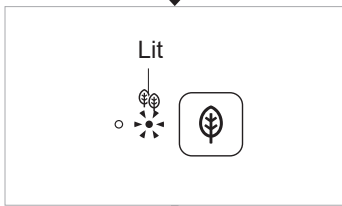
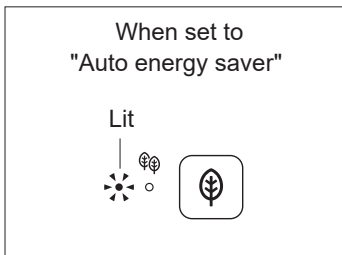

Settings complete

Auto energy saver+

1. 

Press "Auto energy saver+" button.

► The setting changes each time the button is pressed once.

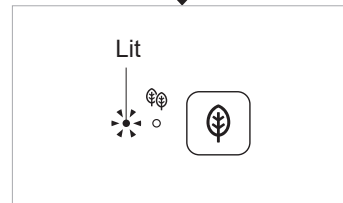
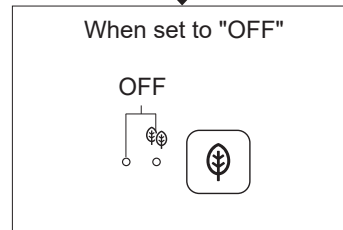
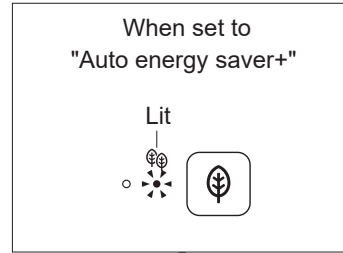

Settings complete

Timer energy saver

Set the "Timer energy saver" at the time you want to start it.

Example: To save energy from 1 am to 7 am (for 6 hours)

1.

When the time of the day reaches 1:00 am at night, press "Timer energy saver" button.

Press the "Timer energy saver" button repeatedly until the "6" LED illuminates.

► The setting changes each time the button is pressed once.

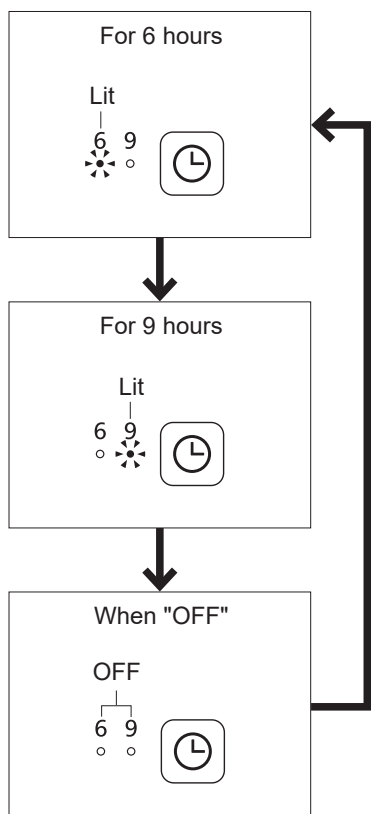

Settings complete

Auto flushing

Set whether or not to clean the bowl unit automatically

1.

Press "Auto flushing" button.

► The setting changes each time the button is pressed once.

Set whether or not to clean the bowl unit automatically.

Check the "Auto flushing" LED (→Page 25)

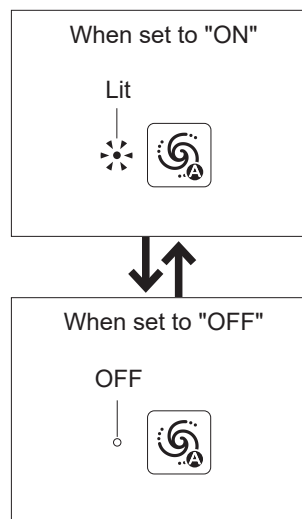

Settings complete

Changing Settings

Auto flush delay*1

Change the amount of time before the toilet flushes automatically

1. 

Press "Stop" button until all LEDs on the remote control are lit or flashing. (about 10 seconds)

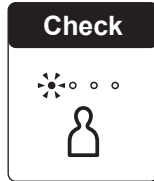

2. 

Press "Rear washing" button.

3. 

Press "Front washing" button.

4. Choose and press the button of the item that you want to set.

Change the amount of time before the toilet flushes automatically.

| | | |
|--|--|---|
| <p>When set to "SET1"</p> <p>Press "Water pressure adjustment -" button.</p> <p>—</p> <p>Short beeps</p> | <p>When set to "SET2"</p> <p>Press "Rear washing" button.</p>  <p>Long beep</p> | <p>When set to "SET3"</p> <p>Press "Water pressure adjustment +" button.</p> <p>+</p> <p>Short beep</p> |
|--|--|---|

- SET 1 (Short) : After about 5 seconds
- SET 2 (Standard) : After about 10 seconds
- SET 3 (Long) : After about 15 seconds

Note: If "Auto flush lid closed" is turned ON, the toilet lid closes before flushing the bowl unit as above.

Settings complete

Auto flush lid closed

Set whether or not to close the toilet lid automatically before flushing the bowl unit

1. 

Press "Stop" button until all LEDs on the remote control are lit or flashing. (about 10 seconds)

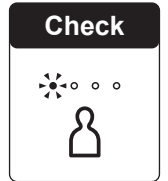



2. 

Press "Rear washing" button.

3. +

Press "Water pressure adjustment +" button.

4. Choose and press the button of the item that you want to set.

| | |
|--|--|
| <p>When set to "ON"</p> <p>Press "Rear washing" button.</p>  <p>Short beep</p> | <p>When set to "OFF"</p> <p>Press "Front washing" button.</p>  <p>Long beep</p> |
|--|--|

Settings complete

*1 The length of time specified for "Auto close delay (Auto flush lid closed)" if "Auto flush lid closed" is turned ON.

About "Auto flush lid closed"...

About 10 seconds after you stand up or move away from the bowl unit if you use the toilet in standing position, the toilet lid closes automatically before flushing the bowl unit.

Also, if you press the Flush buttons ("Full flush" or "Light flush") on the remote control, the toilet lid closes before flushing the bowl unit.

Using the toilet seat

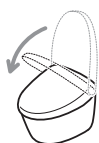

Stand up

The toilet lid closes in about 10 seconds.

- ▶ The toilet lid closes before flushing the bowl unit.

Using the toilet in standing position



Move away

The toilet lid and toilet seat close

About 10 seconds after the user has moved about 1 ft (about 30 cm) away

- ▶ The toilet seat and lid close before flushing the bowl unit.

Using the flush buttons on the remote control

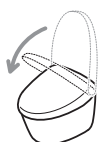

Press

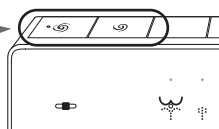

The toilet lid closes.

- ▶ The toilet lid closes before flushing the bowl unit.

"Auto flush lid closed" does not work if "Auto flushing" and "Auto open / close" are set as below: (Except when using the Flush buttons on the remote control)

| | Auto flushing | Auto open / close |
|----|---------------|-------------------|
| 1) | OFF | ON |
| 2) | ON | OFF |
| 3) | OFF | OFF |

- 1) The toilet lid closes automatically but the bowl unit does not flush.
- 2) The bowl unit flushes automatically but the toilet lid does not close.
- 3) The toilet lid does not open / close and the bowl unit does not flush automatically.

Turn both "Auto flushing" and "Auto open / close" ON. (→Pages 29, 32)

Even if "Auto flushing" is turned ON, "Auto flush lid closed" may not work in some cases. For details, refer to "Auto flush lid closed" does not work" in "Troubleshooting". (→Page 63)

Note: You can change the length of time before water flushes after closing the toilet lid automatically to [SET 1], [SET 2], or [SET 3]. (→Page 30)

If you get up slightly from the seat or sit forward on the seat while seated on it, the seat switch may not detect properly, which results in the toilet lid being closed and bowl unit being flushed.

Sit back on the toilet seat. (→Page 9)

While using the toilet in standing position, the toilet lid may close and the bowl unit may be flushed. Stand straight in front of the bowl unit.

Changing Settings

Auto open / close

Set whether or not to open and close the toilet lid automatically



Press "Auto open / close" button.

- ▶ The setting changes each time the button is pressed once.

Set whether or not to open and close the toilet lid automatically.

Check the "Auto open/close" LED (→Page 25)

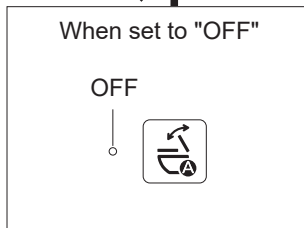
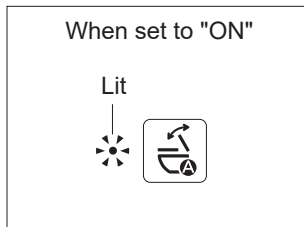

Settings complete

Auto close delay*1

Change the amount of time before the lid/seat closes automatically



Press "Stop" button until all LEDs on the remote control are lit or flashing. (about 10 seconds)

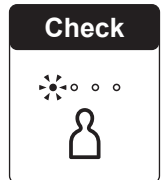

Press "Front washing" button.



Press "Rear washing" button.

4. Choose and press the button of the item that you want to set.

Change the amount of time before the lid/seat closes automatically.

| | |
|---|--|
| <p>When set to "SET1"*2</p> <p>Press "Water pressure adjustment -" button.</p> <p>—</p> <p>Short beep</p> | <p>When set to "SET2"</p> <p>Press "Water pressure adjustment +" button.</p> <p>+</p> <p>Long beep</p> |
|---|--|

SET 1 (Short) : After about 25 seconds
(After you stand up from the toilet seat)

SET 2 (Standard): After about 90 seconds
(When you move away)

Settings complete

*1 If "Auto flush lid closed" is turned ON, you cannot use this setting to change the length of time before closing the toilet lid automatically. Configure the settings for "Auto flush delay". (→Page 30)

*2 When set to "SET 1", the lid/seat does not open automatically for about 15 seconds after closing automatically.

Auto open delay

Change the time period till automatic opening
(After closing by hand or remote control.)

1. ■

Press "Stop" button until all LEDs on the remote control are lit or flashing.
(about 10 seconds)

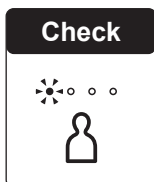

2.

Press "Front washing" button.

3. +

Press "Water pressure adjustment +" button.

4. Choose and press the button of the item that you want to set.

Change the time period till automatic opening.

| | | |
|---|---|---|
| When set to "SET1" Press "Rear washing" button. Long beep | When set to "SET2" Press "Front washing" button. Short beep | When set to "SET3" Press "Water pressure adjustment -" button. - Short beeps |
|---|---|---|

SET 1 (Short) : After about 15 seconds
 SET 2 (Middle) : After about 30 seconds
 SET 3 (Long) : After about 90 seconds

Settings complete

Seat/lid

Automatically open and close the toilet lid/
Automatically open and close the toilet seat and toilet lid

1. ■

Press "Stop" button until all LEDs on the remote control are lit or flashing.
(about 10 seconds)

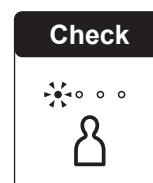

2.

Press "Front washing" button.

3. -

Press "Water pressure adjustment -" button

4. Choose and press the button of the item that you want to set.

**Automatically open and close the toilet lid/
Automatically open and close the toilet seat and toilet lid.**

| | |
|--|---|
| When set to "Lid" Press "Rear washing" button. Long beep | When set to "Seat · lid" Press "Front washing" button. Short beep |
|--|---|

Settings complete

Changing Settings

Auto wand CLEAN

Set whether or not to clean the wand automatically

1. ■

Press "Stop" button until all LEDs on the remote control are lit or flashing. (about 10 seconds)

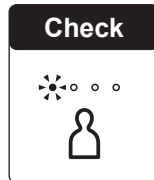

2. +

Press "Water pressure adjustment +" button.

3.

Press "Rear washing" button.

4. Choose and press the button of the item that you want to set.

Set whether or not to clean the wand automatically.

| | |
|--|--|
| When set to "ON" Press "Water pressure adjustment +" button. + Short beep | When set to "OFF" Press "Water pressure adjustment -" button. - Long beep |
|--|--|

Settings complete

Pre-mist

Set whether or not to spray mist in the bowl unit automatically

1. ■

Press "Stop" button until all LEDs on the remote control are lit or flashing. (about 10 seconds)

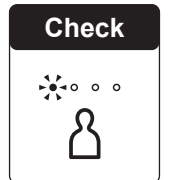

2. +

Press "Water pressure adjustment +" button.

3.

Press "Front washing" button.

4. Choose and press the button of the item that you want to set.

Set whether or not to spray mist in the bowl unit automatically.

| | |
|---|---|
| When set to "Spray" Press "Water pressure adjustment +" button. + Short beep | When set to "do not spray" Press "Water pressure adjustment -" button. - Long beep |
|---|---|

Settings complete

Deodorizer

Set whether or not to deodorize automatically after sitting on the toilet seat

1. ■

Press "Stop" button until all LEDs on the remote control are lit or flashing. (about 10 seconds)

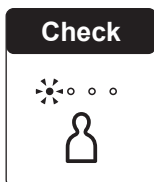

2. -

Press "Water pressure adjustment -" button.

3. 

Press "Front washing" button.

4. Choose and press the button of the item that you want to set.

Set whether or not to deodorize automatically after sitting on the toilet seat.

| | |
|---|---|
| <p>When set to "ON"</p> <p>Press "Water pressure adjustment +" button.</p> <p>+</p> <p>Short beep</p> | <p>When set to "OFF"</p> <p>Press "Water pressure adjustment -" button.</p> <p>-</p> <p>Long beep</p> |
|---|---|

Settings complete

Auto power deodorizer

Set whether or not to power deodorize automatically after standing up

1. ■

Press "Stop" button until all LEDs on the remote control are lit or flashing. (about 10 seconds)

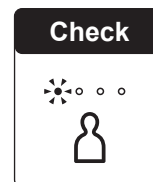

2. -



Press "Water pressure adjustment -" button.

3. +

Press "Water pressure adjustment +" button.

4. Choose and press the button of the item that you want to set.

Set whether or not to power deodorize automatically after standing up

| | |
|---|---|
| <p>When set to "ON"</p> <p>Press "Rear washing" button.</p> <p></p> <p>Short beep</p> | <p>When set to "OFF"</p> <p>Press "Front washing" button.</p> <p></p> <p>Long beep</p> |
|---|---|

Settings complete

Changing Settings

Soft light

Set whether or not to use the soft light

1.  and 

Press and hold both the "Stop" button and "Water pressure adjustment +" button until the remote control LEDs are lit or flashing. (about 10 seconds)

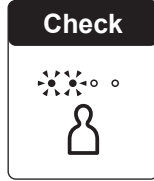

2. 



Press "Rear washing" button.

3. 

Press "Water pressure adjustment +" button.

4. Choose and press the button of the item that you want to set.

Set whether or not to use the light inside the bowl unit.

| | |
|---|--|
| <p>When set to "ON"</p> <p>Press "Rear washing" button.</p>  <p>Short beep</p> | <p>When set to "OFF"</p> <p>Press "Front washing" button.</p>  <p>Long beep</p> |
|---|--|

Settings complete

Enable/disable the Night light, a lighting mode suitable for night, and set the time window

To set the time window (timer), set the desired start time.

1.  and 

Press and hold both the "Stop" button and "Water pressure adjustment +" button until the remote control LEDs are lit or flashing. (about 10 seconds)

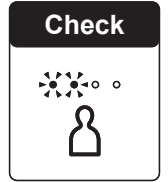



2. 

Press "Front washing" button.

3. 

Press "Water pressure adjustment +" button.

4. Choose and press the button of the item that you want to set.

| | | |
|--|---|---|
| <p>When set to "ON"</p> <p>ON</p> <p>Press "Rear washing" button.</p>  <p>Short beep</p> | <p>When set to "OFF"</p> <p>STANDBY</p> <p>Press "Front washing" button.</p>  <p>Long beep</p> | <p>When set to "the time window"</p> <p>TIMER</p> <p>Press "Water pressure adjustment -" button.</p> <p>—</p> <p>Short beep</p> |
|--|---|---|

Settings complete

About "Night light"...

You can change "Soft light" to "Night mode", a lighting mode suitable for night.

Note: The light does not turn on if "Soft light" is turned OFF.

The "Night light" is turned ON

Soft light

Lights permanently

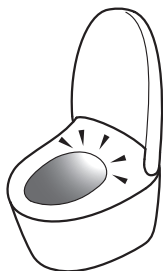

The "Night light" is turned OFF [STANDBY]

Soft light

Lights up as specified in the settings

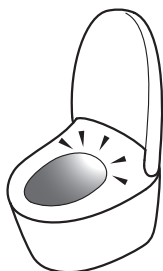

The "Night light" is configured with the timer

ON



OFF [STANDBY]

The light turns ON / OFF [STANDBY] every 12 hours starting from the set time.

Example

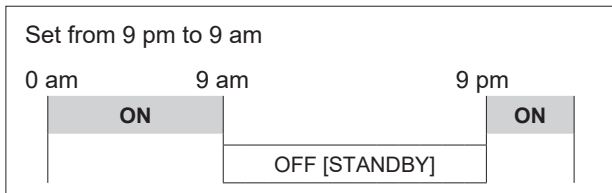

Anti freezing

Set whether or not to run the water for the bowl unit and top unit automatically at a fixed interval in order to prevent freezing

1. ■ and +

Press and hold both the "Stop" button and "Water pressure adjustment +" button until the remote control LEDs are lit or flashing. (about 10 seconds)

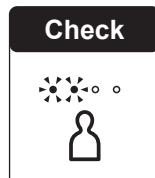

2. -

Press "Water pressure adjustment -" button.

3.

Press "Front washing" button.

4. Choose and press the button of the item that you want to set.

<For setting to [ON]>

When the time is set, the bowl unit is cleaned in about 5 minutes intervals to prevent freezing.

| | |
|--|--|
| When set to "ON" Press "Water pressure adjustment +" button. + Short beep | When set to "OFF" Press "Water pressure adjustment -" button. - Long beep |
|--|--|

Settings complete

Changing Settings

Beep sound

Set whether or not to make a beep sound

1. ■ and +

Press and hold both the "Stop" button and "Water pressure adjustment +" button until the remote control LEDs are lit or flashing. (about 10 seconds)

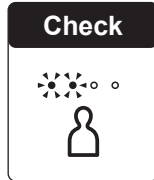

2. -

Press "Water pressure adjustment -" button.

3. 

Press "Rear washing" button.

4. Choose and press the button of the item that you want to set.

Set whether or not to make a beep sound.

| | |
|---|---|
| <p>When set to "ON"</p> <p>Press "Water pressure adjustment +" button.</p> <p style="text-align: center;">+</p> <p style="text-align: center;">Short beep</p> | <p>When set to "OFF"</p> <p>Press "Water pressure adjustment -" button.</p> <p style="text-align: center;">-</p> <p style="text-align: center;">Long beep</p> |
|---|---|

Settings complete

Pressure / position setting

Set whether or not to keep your favorite pressure and position settings

1. ■ and +

Press and hold both the "Stop" button and "Water pressure adjustment +" button until the remote control LEDs are lit or flashing. (about 10 seconds)

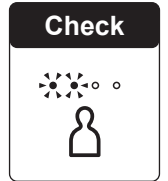

2. 

Press "Rear washing" button.

3. +

Press "Water pressure adjustment +" button.

4. -

Press "Water pressure adjustment -" button
▶ The current setting is displayed.

5. -

Press "Water pressure adjustment -" button
▶ The setting changes each time the button is pressed once.

Pressure/Position setting

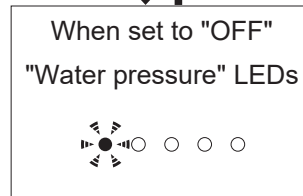
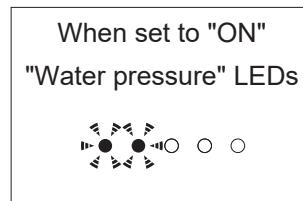

6. ■

Press "Stop" button.

Settings complete

Personal setting

Set whether or not to use the personal setting

1. ■ and +

Press and hold both the "Stop" button and "Water pressure adjustment +" button until the remote control LEDs are lit or flashing. (about 10 seconds)

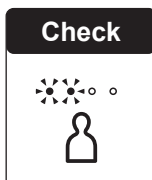

2. -

Press "Water pressure adjustment -" button.

3. +

Press "Water pressure adjustment +" button.

4.

Press "Front washing" button.
▶ The current setting is displayed.

5. -

Press "Water pressure adjustment -" button
▶ The setting changes each time the button is pressed once.

Personal setting

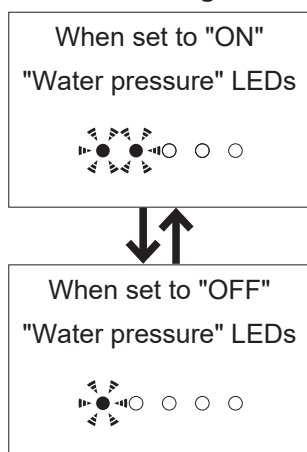

6. ■

Press "Stop" button.
Settings complete

Registering Personal Settings*1

Register your preferred wand position, etc.

1.

Press "Personal setting" button.

Select the location to be set

▶ The setting changes each time the button is pressed once.

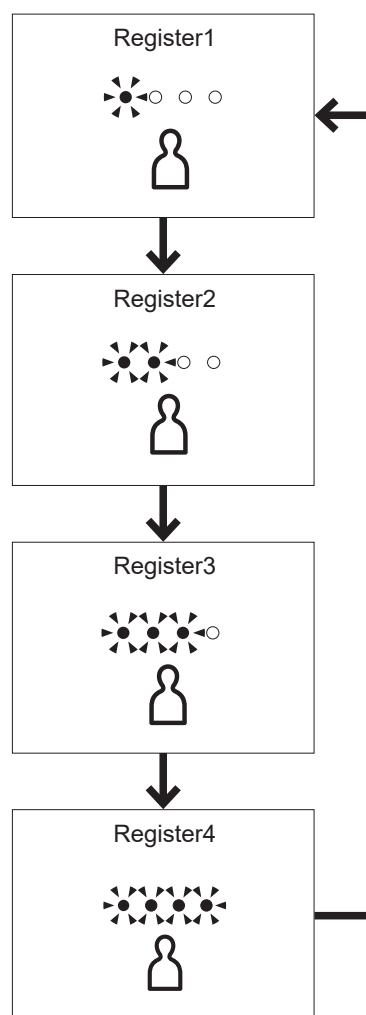

2. Set your preferences for "Wand position", "Water pressure" and "Warm water temperature" during "Rear washing", etc.

3.

Press "Personal setting" button about 5 seconds or longer. (Short beep)

Settings complete

*1 Cannot be performed when "Personal setting" is set to "OFF".

Maintenance

Before Maintenance

WARNING

Always turn off the power before maintenance or inspection.

Failure to do so may cause electric shock or malfunction, resulting in a breakdown.

For safety, turn the power OFF before maintenance.*1*2

When the power is turned OFF, the Power LED is unilluminated.

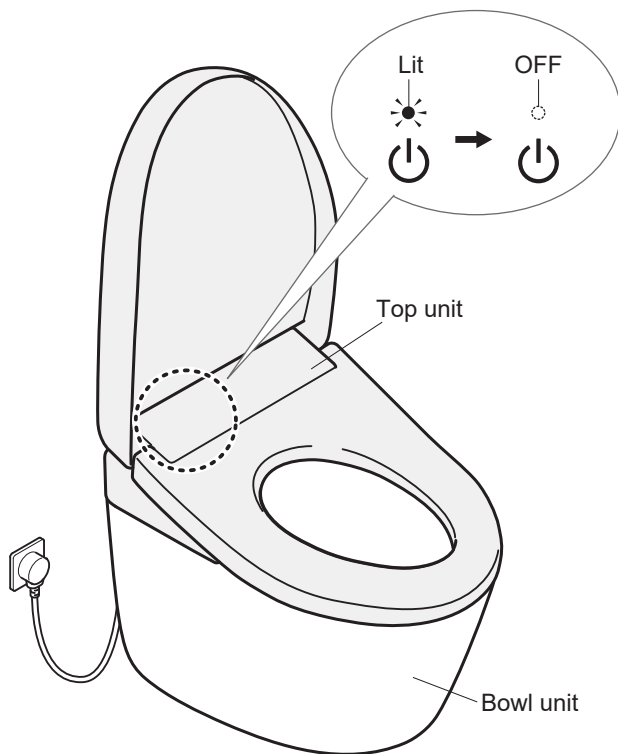

To turn the power "OFF"

Unplug the power plug.

To turn the power "ON"

Insert the power plug.

▶ The "Power" LED illuminates.

Power Plug

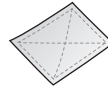

• Dry cloth



• Wet cloth

Approximately once a month

1. Unplug the power plug and wipe it with a dry cloth.



2. Insert the power plug.

▶ The "Power" LED illuminates.

WARNING

Periodically remove dust from the blades and other parts of the power plug.

Unplug the power plug and wipe it with a dry cloth.

Fully insert the power plug.

When unplugging the power plug, hold the main body of the power plug.

Pulling the power cord may damage the power plug or power cord.



*1 Except when using "Wand cleaning"

*2 The toilet lid does not open automatically for about 10 to 60 seconds after the power is turned ON (preparing).

Operate with the remote control.

Top Unit



- Soft cloth soaked in water

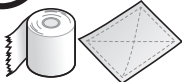

- Toilet paper
 - Dry cloth
 - Nylon scrubbing brush
- May cause damage.

Approximately daily

1. Turn the power "OFF". (→Page 40)

2. Wipe with a soft cloth that has been soaked in water and wrung out thoroughly.

For heavy dirt

Wipe with a soft cloth soaked in diluted, pH neutral kitchen detergent, and then wipe with a soft cloth soaked in water.



- pH neutral kitchen detergent



- Paint thinner
- Benzene
- Powdered cleanser

3. Turn the power "ON". (→Page 40)

- ▶ The "Power" LED illuminates.

Attention

This product is an electric appliance. Be careful not to let water seep inside or leave detergent in the gap between the top unit and bowl unit.

Do not put any cleaning solution directly onto the warm air outlet or cover around the wand, etc.

May damage plastic parts or cause a malfunction.

When using a toilet cleaner to clean the toilet, rinse it off within 3 minutes and leave the toilet seat and toilet lid open.

Wipe off any cleaner that remains on the bowl unit.

If vapor from a toilet cleaner enters the top unit, it may cause a malfunction.

<If "Auto flush lid closed" (→Pages 30, 31) is turned ON> (→Page 10)

Do not press or pull the warm air outlet or cover around the wand with excessive force.

Doing so may cause damage or failure.

Wipe the back surface of the toilet seat and the toilet seat cushions with a soft cloth tightly wrung out with water.

Otherwise adhesion of dirt may result in discoloration.

Maintenance

Bowl Unit



- Cleaning sponge
- Brush
- Neutral toilet detergent



- Strongly acidic cleaners or strong alkaline cleaners
- Cleaners containing abrasive compounds
- Fluoride-based detergent (containing hydrogen fluoride or ammonium fluoride)
- Water-repelling cleaner
- Wire brush
- Abrasive nylon scrubbing brush

Approximately daily

1. Turn the power "OFF". (→Page 40)

2. Clean with a cleaning sponge or brush.

If the bowl unit is clogged

Using plunger or similar, provide 4 in (10 cm) or more clearance between the top of the bowl unit and the water surface. Use commercially available tools that are made for unclogging the bowl unit.

(May cause overflow of dirty water and water damage.)

If the floor is dirty

Clean it with a well wrung cloth.

Otherwise, stains or corrosion may occur on the floor.

Note: Sitting is recommended to reduce splashing caused by standing and urinating.

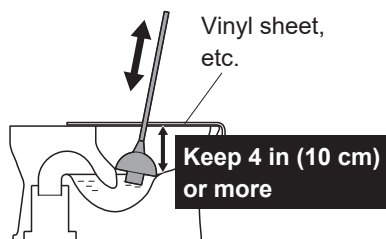

3. Turn the power "ON". (→Page 40)
 - ▶ The "Power" LED illuminates.

Attention

Be careful not to expose the top unit or the gap between it and the bowl unit to water.

Otherwise, water may overflow into the room.

Do not use any water repellent, stain-proofing cleaner or surface coating agent. These products would not damage the porcelain surface, but they may cover the porcelain surface and reduce the effect of the built-in stain prevention technology.

Gap between the Top Unit and Bowl Unit

You can lift up the top unit with the cleaning lift button and clean the gap between it and the bowl unit.



- Soft cloth soaked in water

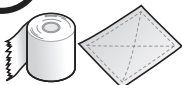

- Toilet paper
 - Dry cloth
 - Nylon scrubbing brush
- May cause damage.

Approximately once a month

1. Turn the power "OFF". (→Page 40)

2. Open the toilet seat and lid.

3. Press the cleaning lift button.

- ▶ This raises the front side of the top unit.

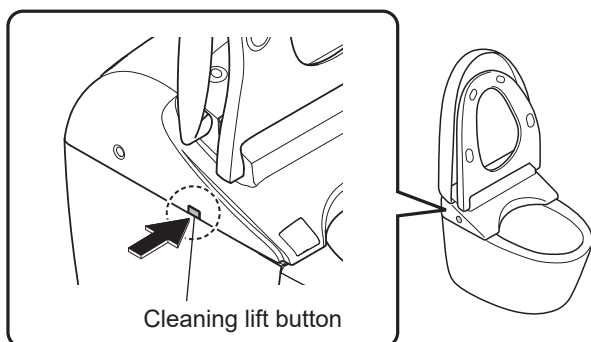

4. Clean the gap.

- ▶ Wipe with a soft cloth soaked in a diluted, neutral kitchen detergent. Then, wipe it with a soft cloth soaked in water so that no detergent remains.

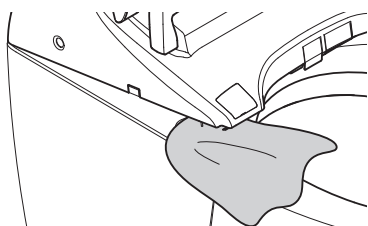

⚠ CAUTION

Do not use the product while the top unit is lifted up by the cleaning lift.

When lowering the top unit by the cleaning lift, do not insert your fingers into the gap between the top unit and the bowl unit.

Attention

Do not directly spray cleaner and water.

Do not force the toilet seat or lid to move while the top unit is raised up.

5. Close the toilet seat.

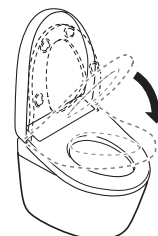

6. Push the top unit down firmly until a click sound is no longer heard.

Make sure to push these locations

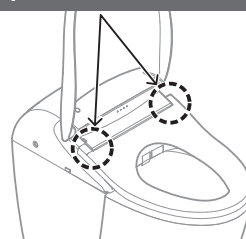

Push it straight down

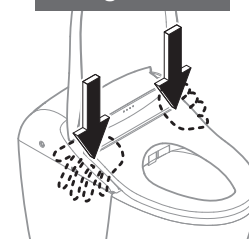

*Up to 6 clicks can be heard.

7. Turn the power "ON". (→Page 40)

- ▶ The "Power" LED illuminates.

Maintenance

Gap between the Top Unit and the Toilet Lid

The toilet lid can be removed for thorough cleaning.



- Soft cloth soaked in water

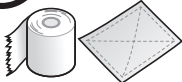

- Toilet paper
 - Dry cloth
 - Nylon scrubbing brush
- May cause damage.

Approximately once a month

1. Turn the power "OFF" (→Page 40)

2. Remove the toilet lid.

Slightly tilt the toilet lid to the front.

- A** Pull left side outward.
- B** Disconnect the hinge from the tab and pull up.
- C** Remove the toilet lid.

Hold with both hands

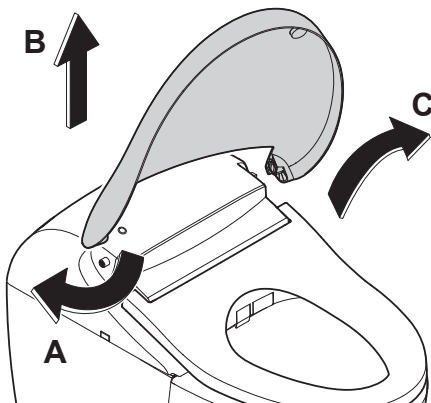

3. Wipe with a soft cloth that has been soaked in water and wrung-out thoroughly.

4. Reinstall the toilet lid.

- D** Align the right side pin and hinge parts. Slightly tilt the toilet lid to the front.
- E** While pulling left side outward.
- F** Mount by joining the hinge with the tab.

Attention

Be careful not to pinch your fingers.

Hold with both hands

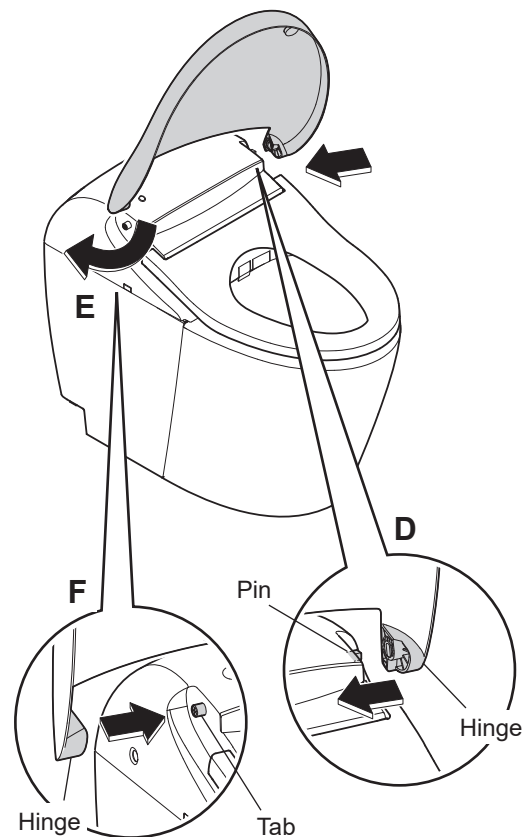

5. Turn the power "ON". (→Page 40)

▶ The "Power" LED illuminates.

6. Open and close the toilet lid to check the reinstallation.

Wand



- Soft cloth soaked in water

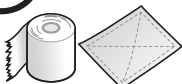

- Toilet paper
 - Dry cloth
 - Nylon scrubbing brush
- May cause damage.

Approximately once a month If you notice dirt (Wand cleaning)

1. Extend the wand.

Remote control back side

How to remove the remote control (→Page 14)



- 1) Press "Wand cleaning" button.

- ▶ The wand extends and water sprays out for cleaning.
- ▶ The wand automatically retracts after about 5 minutes.

2. Wipe with a soft cloth that has been soaked in water and wrung out thoroughly.

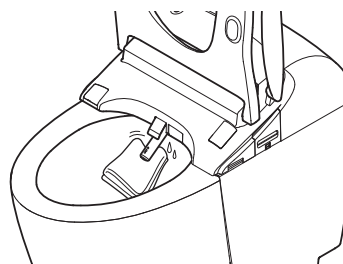

Attention

Do not pull, push or press the wand with excessive force.
May cause damage or malfunction.

3.  Press "Stop" button.
▶ The wand retracts.

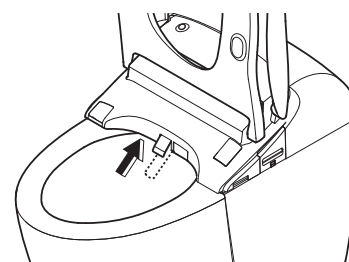

Maintenance

Deodorizing Filter

Approximately once a month

1. Turn the power "OFF". (→Page 40)
2. Remove the deodorizing filter.
Hold the tab and pull outward.

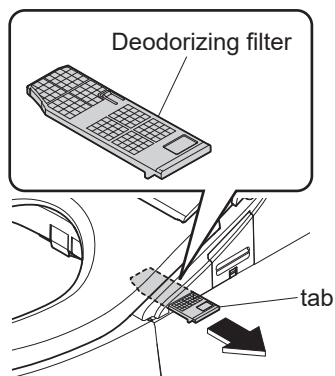

Attention

Do not pull the unit with undue force.
Doing so may cause damage or malfunction.

3. Clean with a tool such as a toothbrush.
 - ▶ When washing with water, dry off all water before reinserting.

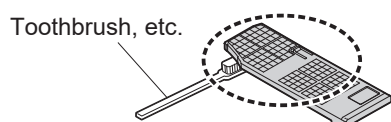

4. Reinsert the deodorizing filter.

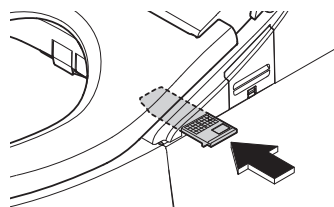

Push firmly until a click sound is heard.

5. Turn the power "ON". (→Page 40)
 - ▶ The "Power" LED illuminates.

Drain Plug With Water Supply Filter

Approximately once every 6 months
If you think the water pressure has weakened

1. Close the shutoff valve.
 - ▶ The water supply stops.

⚠ CAUTION

Do not remove the drain plug with water supply filter while the shutoff valve is open.
Otherwise, water may leak out.

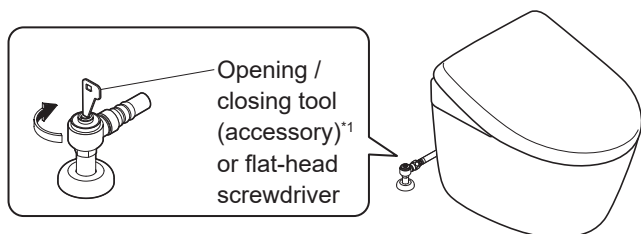

2.  Press "Wand CLEAN" button.
 - Release the pressure from the water supply pipe.

3. Turn the power "OFF". (→Page 40)

4. Open the toilet seat and lid.

5. Open the cover and remove the drain plug with water supply filter.

- 1) Insert a flat-head screwdriver in the hook of the cover to open it.

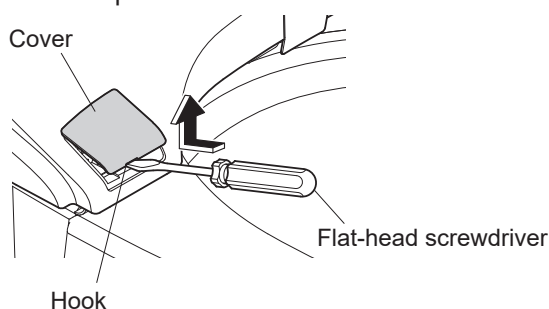

- 2) Loosen the drain plug with water supply filter with a flat-head screwdriver and then pull it.

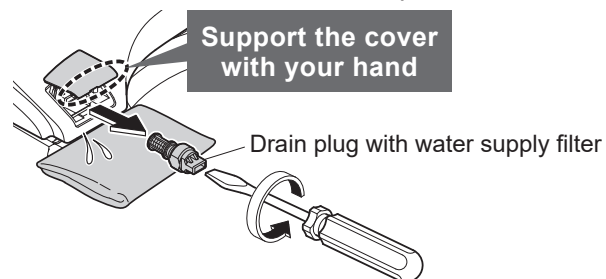

6. Clean the filter with a tool such as a toothbrush.
 - ▶ Also, remove any dust from inside the hole of the drain plug with water supply filter.

7. Reinstall the drain plug with water supply filter and close the cover.

- 1) Insert the drain plug with water supply filter and use a flat-head screwdriver to tighten it securely.

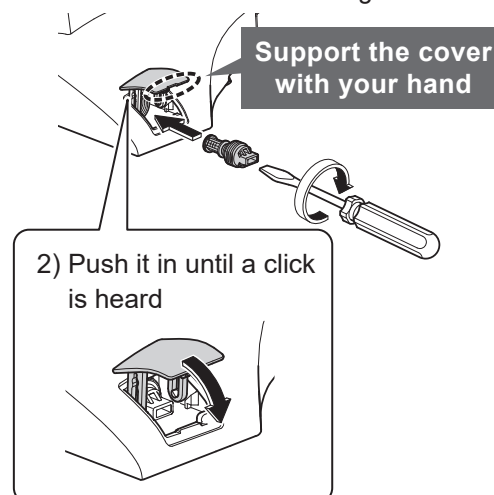

8. Turn the power "ON". (→Page 40)
 - ▶ The "Power" LED illuminates.

9. Open the shutoff valve.

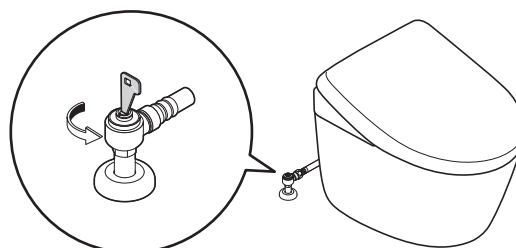

*1 Use the supplied opening/closing tool.

Maintenance

Water Supply Filter (Bowl Unit)

Approximately once every 6 months

1. Close the shutoff valve.
 - ▶ The water supply stops.

⚠ CAUTION

Do not remove the water supply filter while the shutoff valve is open.
Otherwise, water may leak out.

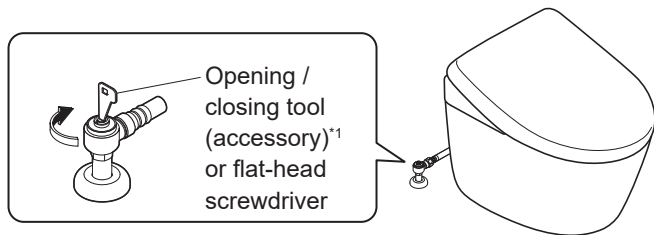

Always perform this step

2.  Press the "Wand CLEAN" button.
 - Release the pressure from the water supply pipe. (Otherwise, water may leak out.)

3. Turn the power "OFF". (→Page.40)

4. Loosen the cap of the water supply filter to remove the water supply filter.

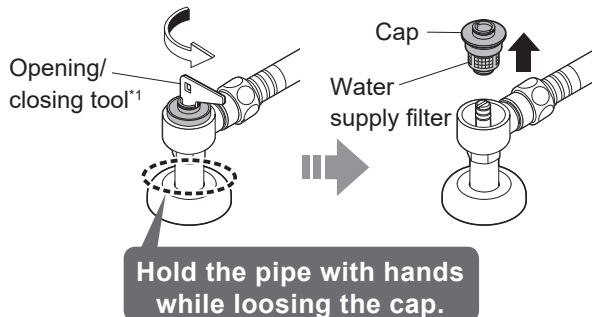

5. Remove the water supply filter from the cap and clean it with a toothbrush or similar instrument.

Attention

Do not use detergent.
Do not apply excessive force to the water supply filter.
Otherwise, deformation may occur.

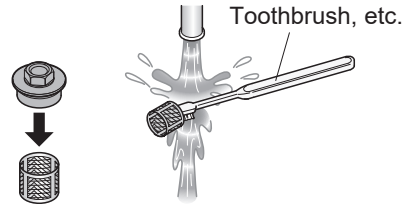

6. Attach the water supply filter to the cap.



7. Install the cap of the water supply filter to the original position and tighten it with the opening/closing tool.

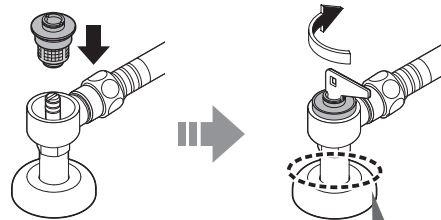

Hold the pipe with hands while tightening the cap.

8. Open the shutoff valve.
 - ▶ Check that there are no leaks in the shutoff valve or plumbing connections.

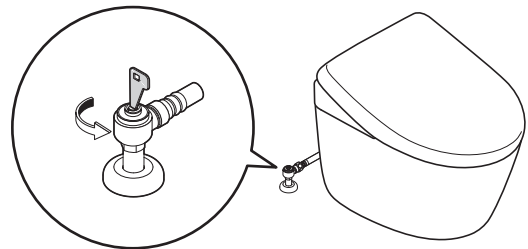

9. Turn the power "ON". (→Page.40)
 - ▶ The "Power" LED illuminates.

*1 Use the supplied opening/closing tool.

What to Do?

If the water does not flow due to a power outage (when water failure hasn't occurred)

You can flush the bowl unit with the manual water supply knob (orange) and manual water drainage cord (white).

Manual water supply knob (orange)

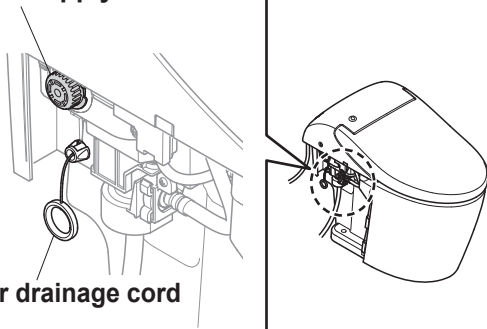

Manual water drainage cord (white)

Watch video

If the water does not flow due to a power outage

<https://vimeo.com/871607413?share=copy>



*May incur communication charges.

*You may not be able to watch the video depending on your environment.

1. Remove the access cover (left).

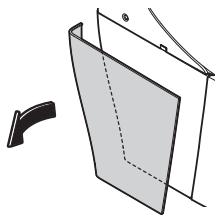

2. Open the toilet lid.

3. Fully open the manual water supply knob (orange).

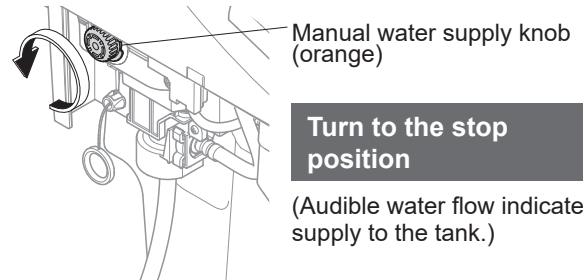

Turn to the stop position

(Audible water flow indicates supply to the tank.)

Attention

Make sure to stop the water supply with the manual water supply knob (orange) in step 6.

Failure to do so causes water to continuously flow to the bowl unit.

4. Pull the manual water drainage cord (white) for about 4 seconds or longer.

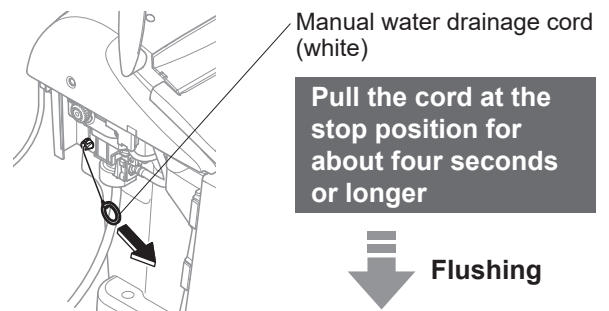

Manual water drainage cord (white)

Pull the cord at the stop position for about four seconds or longer



Flushing

When the bowl unit finishes flushing, release the cord

Attention

If the water in the bowl unit does not drain after pulling the Manual water drainage cord (white), the bowl unit may be clogged.

Turn the manual water supply knob (orange) to its stop position and unclog the bowl unit. (→Page 42)
Water may overflow.

After unclogging the bowl unit, try again from step 3.

What to Do?

- 5.** Wait for one minute.
- ▶ Water is supplied to the tank for the next time it is flushed.

Always perform this step

- 6.** Close the manual water supply knob (orange).

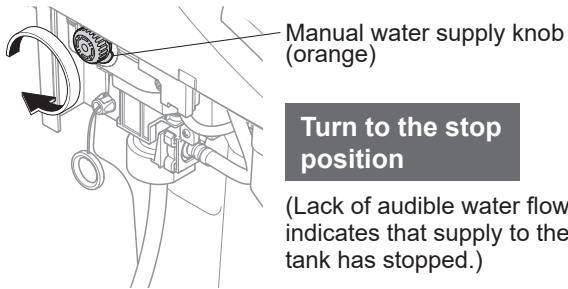

Attention

Make sure to turn the manual water supply knob (orange) to stop water supply.

Otherwise, water will continue to flow.

If the waste material does not flush down completely, repeat the procedure from step 3.

- 7.** Attach the left access cover.
- ▶ Attach it so that there are no gaps between it and the top/sides of the bowl unit.

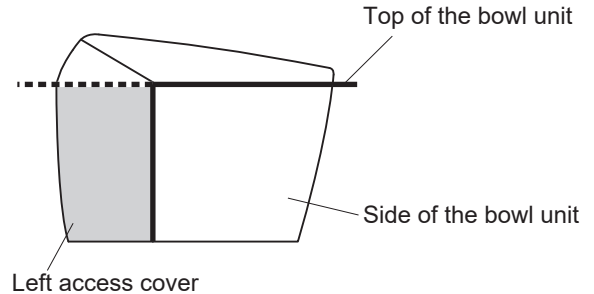

Attention

When power is restored, be sure to perform a full flush.

To prevent waste from remaining in the discharge pipe.

You can also flush the bowl unit with a bucket.

(→Page 51)

If the water does not flow due to a water service interruption

1. Use a bucket to flush the bowl unit.
(About 6–8 L)

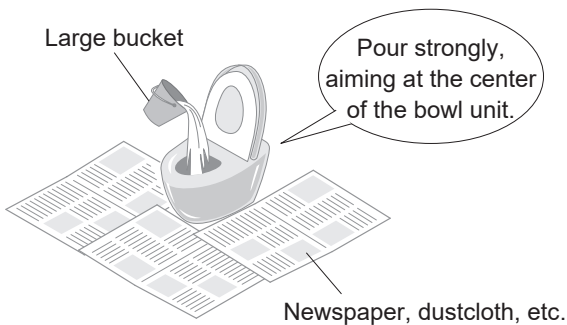

2. If the water level is low after flushing, add more water.
(Until the water level does not rise further.)
▶ Prevents odors.

Attention

Before starting work, turn "Auto flushing" OFF.
(→Page 29)

When the water supply is restored, make sure to first use water in the bath or kitchen (not with this product) to remove air from the water supply pipes.

Otherwise, air or foreign objects may enter this product, causing failure.

After that, be sure to perform a full flush.

To prevent waste from remaining in the drain pipe.

If you cannot operate with the remote control

Flush is also possible using the buttons on the right side of top unit.

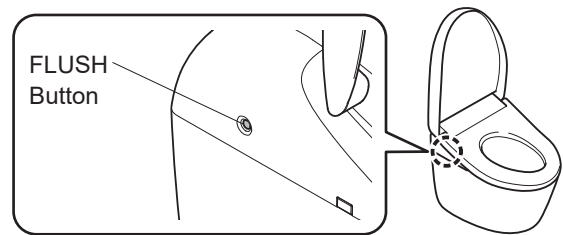

If the low battery warning mark "  " on the surface of the remote control is flashing, please replace the batteries.

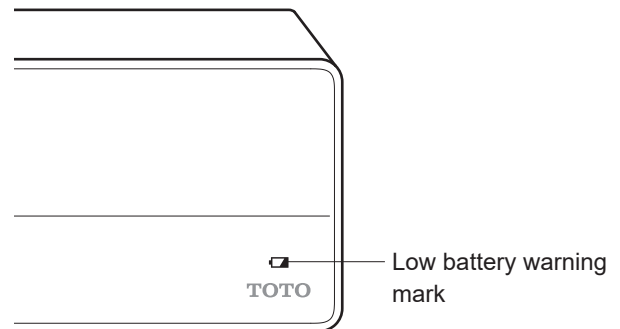

What to Do?

Replacing the batteries

1. Turn the power "OFF". (→Page 40)
2. Remove the remote control from the hanger. (→Page 14)
3. Open the battery cover and replace with two new AAA batteries. (→Page 14)
 - ▶ The low battery warning mark is unilluminated.
4. Mount the remote control in the hanger. (→Page 14)
5. Turn the power "ON". (→Page 40)
 - ▶ The "Power" LED illuminates.

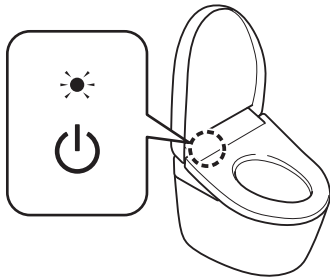

Attention

"ON" and "OFF" settings of the functions such as the energy saver function may be canceled when the batteries are replaced. Set them again.

Freeze Damage Prevention

When the ambient temperature is likely to drop to 32 °F (0 °C) or lower, take measures to prevent freezing.

Attention

When the ambient temperature is likely to drop to 32 °F (0 °C) or lower, do not use the energy saver feature. Otherwise, the product may break down.

Warm the bathroom or take measures against freezing so that the ambient temperature does not drop below 32 °F (0 °C).

Before starting to work, set "Auto flushing" (→Page 29) and "Auto open/close" (→Page 32) to "OFF".

How to Freeze Damage Prevention (Dynamic mode)

This function runs the water for the bowl unit and top unit automatically at a fixed interval in order to prevent freezing.

How to Set

1. Turn "Anti freezing" ON with the remote control. (→Page 37)
 - ▶ The "Power" LED flashes.
 - The toilet flushes at intervals of about 5 minutes.
 - About 1.69 oz (about 50 ml) of water comes out from near the wand at intervals of about 5 minutes. (The wand remains retracted.)

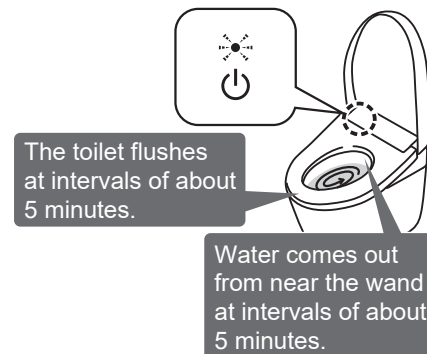

Long Periods of Disuse

If the toilet is in a location you will not visit for a long time, drain the water.

The water in the tank may cause malfunctions or become contaminated and cause skin irritation or other problems.

(The water may freeze, causing damage to the product.)

Attention

When there is a risk of freezing, take measures to prevent freezing. (→Page 52)

Otherwise, the product may break down.

Note: Do not drain water when the top unit is lifted up with the "Cleaning lift". (→Page 43)

How to drain the water

1. Close the shutoff valve.
 - ▶ The water supply stops.

CAUTION

Do not remove the drain plug with water supply filter while the shutoff valve is open.

Otherwise, water may leak out.

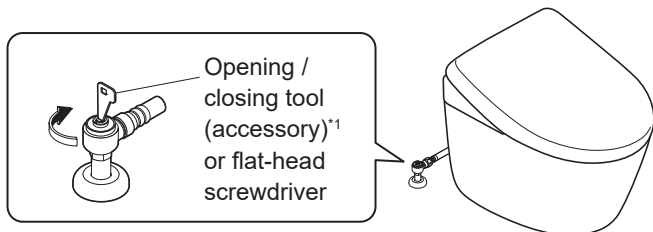

2.  Press "Full flush" button on the remote control to drain the tank.^{*2}

3.  Press "Wand CLEAN" button.
 - Release the pressure from the water supply pipe.

4. Turn the power "OFF". (→Page 40)

5. Drain the pipe.
 - 1) Open the toilet seat and lid.
 - 2) Insert a flat-head screwdriver in the hook of the cover to open it.

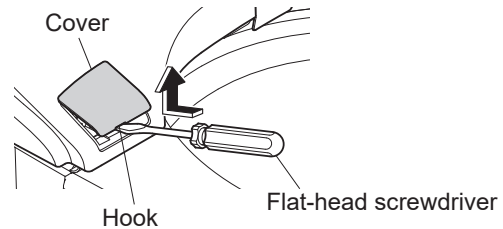

- 3) Loosen the drain plug with water supply filter with a flat-head screwdriver and then pull it.

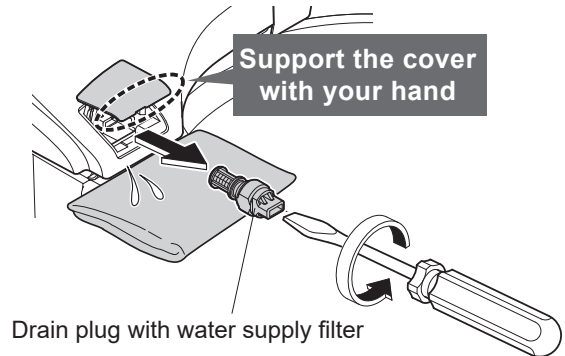

6. Reinstall the drain plug with water supply filter and close the cover.
 - 1) Insert the drain plug with water supply filter and use a flat-head screwdriver to tighten it securely.

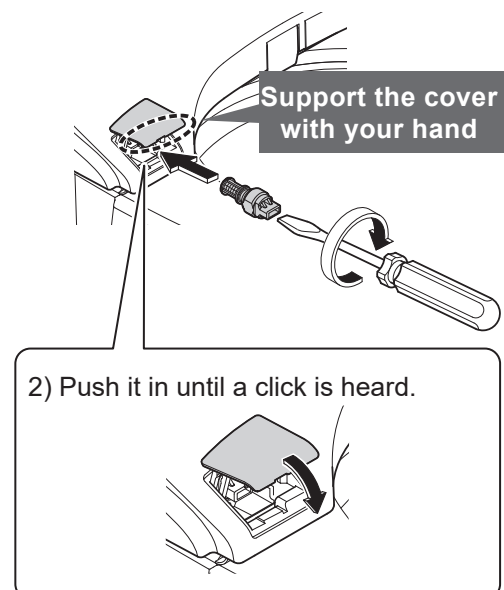

*1 Use the supplied opening/closing tool.

*2 If "Auto flush lid closed" is turned ON, the toilet lid closes before flushing the bowl unit.

What to Do?

- 7.** Pull the water drain lever.
- ▶ Water comes out from near the wand (about 20 seconds).

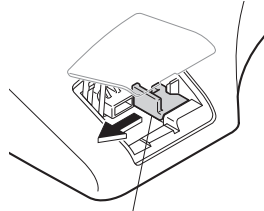

Water drain lever

- 8.** Release the water drain lever to restore it to its original position.

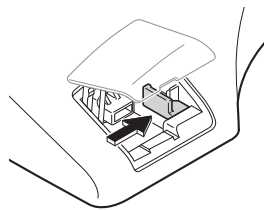

- 9.** Close the cover.

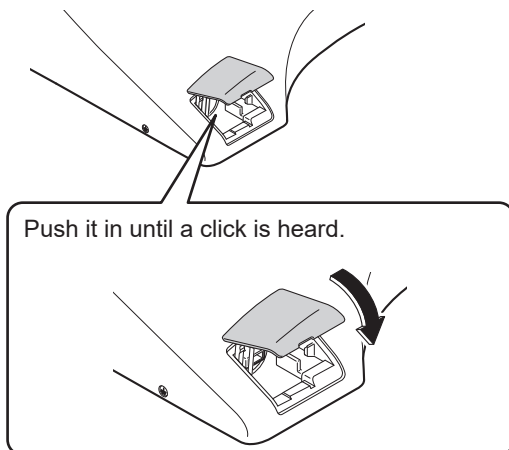

If water may get frozen

- ▶ Add antifreeze solution to the water in the bowl to prevent freezing.
The antifreeze solution should not be flushed out.
Collect it before using the toilet and dispose of it.

To use the product again

- ▶ The water needs to be resupplied. (→See below.)

Resupplying the Water

1. Open the shutoff valve.
 - ▶ Check that water is not leaking from a pipe or the top unit.

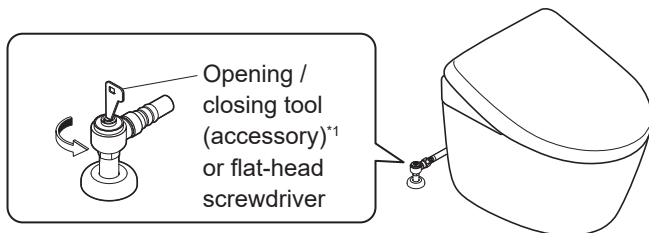

2. If the power is not on, turn the power ON. (→Page 40)
 - ▶ The "Power" LED illuminates.

3. Discharge water from the wand.
 - 1) Pressing down the left side of the toilet seat,
 - 2) 

Press "Rear washing" button to discharge water from the wand.

 - ▶ Catch the water in a paper cup or other receptacle.
 - 3) Release your hand from the toilet seat

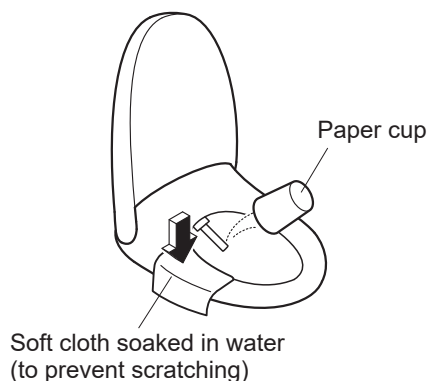

4.

Press "Full flush" button.*2

Attention

The bowl unit cannot be flushed when there is not enough water in the tank.
In this case, do not perform any operations.

- ▶ The LEDs on the main display flashes while water is being supplied to the tank, and then changes to lit when water supply is complete.
It takes about 80 seconds for water supply to complete. (The required time depends on the usage conditions such as the water supply pressure.)

If the remaining water has frozen and no water comes out

- ▶ Heat the inside of the bathroom, and warm the water supply hose and shutoff valve using a cloth soaked in warm water.

5.

After the bowl unit fills with water, press "Full flush" button again.*2

*1 Use the supplied opening/closing tool.

*2 If "Auto flush lid closed" is turned ON, the toilet lid closes before flushing the bowl unit.

Troubleshooting

First, try the actions described on Pages 56–66. If the problem persists, consult the installer, seller, or TOTO Service (→see *contact information on the back cover*).

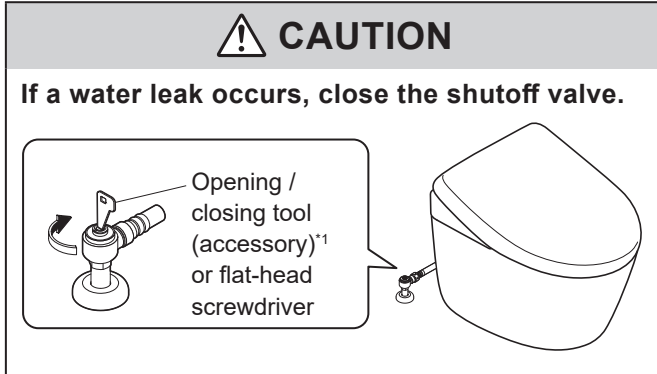

In the following case, unplug the power plug and consult with TOTO customer service (→see *contact information on the back cover*).

"Power" LED, "Seat" LED, and "Energy saver" LED are flickering

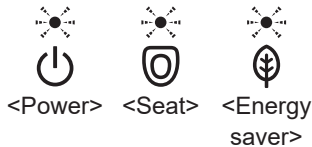

Please check first (A–C)

A: Is the Power LED illuminated?
Is the top unit working?

Is the "Power" LED on the main display flashing?

- ▶ The "Anti freezing" is set to "ON". (→Pages 37, 52)

Is the breaker on the distribution board turned on?

- ▶ Check whether there is a power outage or the breaker has turned "OFF".

Is the "Power ON/OFF" setting "OFF"?

- ▶ Switch it to "ON" with the remote control. (→Page 15 2-2.2)

B: Is the Energy saver LED lit?

- ▶ While the LED is lit, energy saver (→Pages 26, 27) is in operation, so the toilet seat temperature may be reduced or the heater may be turned off.

C: Is the remote control working?

Is the low battery warning mark on the surface of the remote control flashing?

- ▶ Replace the batteries. (→Pages 14, 52)

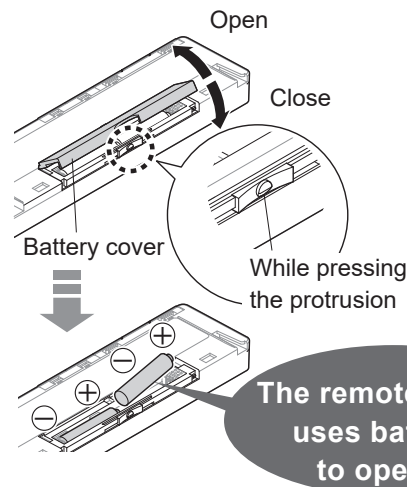

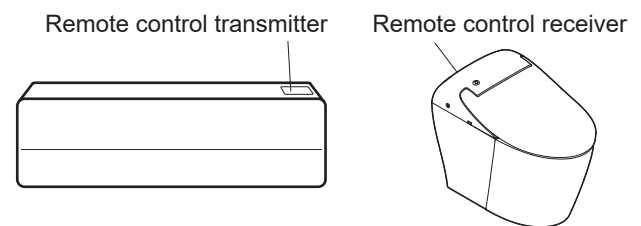

Is the remote control transmitter or the remote control receiver blocked?

- ▶ Remove obstructions, dirt, water droplets or any other blockages.



*1 Use the supplied opening/closing tool.

Rear Washing, Front Washing and Wand

| Trouble | Please check |
|--|--|
| The wand (or washing water) does not come out | <p>When the temperature is low, it takes time for the wand to come out after the remote control button is pressed because the water must be warmed up first.</p> <hr/> <p>Has the toilet been sat "ON" and used continuously for 2 hours or longer? (If so, operation is stopped for safety purposes.)</p> <p>▶ Stand up from the seat and then use again.</p> <hr/> <p>If the water supply pressure drops significantly, for example if water is used elsewhere or if there is a water failure, the function may stop for safety.</p> <p>▶ Turn the power OFF and wait about 10 seconds before turning the power ON again. (→Page 40)</p> <p>If the above symptom reappears There may be a malfunction.</p> <p>▶ Consult with TOTO customer service (→see contact information on the back cover).</p> <hr/> <p>The seat switch will not turn on unless you sit on the seat properly.</p> <p>▶ Sit back on the toilet seat. (→Page 9)</p> |
| | <p>Are you using a toilet seat cover, a toilet lid cover or a seat for infants?</p> <p>▶ Remove any covers. When using a seat for infants or a soft highchair, remove after each use. (→Page 10)</p> |
| | <p> Are you pressing "Wand CLEAN" button?</p> <p> When you press "Wand CLEAN" button, "EWATER+" comes out from the vicinity of the wand to clean the wand.</p> <p>▶ To clean the wand with it extended, perform "Wand cleaning". (→Page 45)</p> |
| The wand extends but the washing water does not come out / The washing water pressure is weak | <p>Has a water failure occurred?</p> <p>▶ ■ Press "Stop" button on the remote control and wait until water service is restored.</p> <hr/> <p>Is the shutoff valve closed?</p> <p>▶ Fully open the shutoff valve. (→Page 15)</p> <hr/> <p>Is the drain plug with water supply filter clogged with foreign matter?</p> <p>▶ Clean the filter. (→Page 47)</p> <hr/> <p>Is the water pressure set to a low level? (→Page 19)</p> |
| The washing water is cold | <p>Is the warm water temperature set to "OFF" or a low level? (→Pages 22, 23)</p> <p>When the temperature of the water supply or the bathroom is low, the water temperature may be low when first sprayed.</p> |
| Stops in the middle of use | <p>"Rear washing", "Rear soft washing" and "Front washing" stop automatically after 5 minutes of continuous use.</p> <hr/> <p>Does the seat switch have difficulty detecting?</p> <p>▶ Sit back on the toilet seat. If you get up slightly from the seat, or sit forward on the seat, the seating switch may temporarily stop detecting your presence. (→Page 9)</p> |

Troubleshooting

Rear Washing, Front Washing and Wand (continue)

| Trouble | Please check |
|---|---|
| Water comes out unexpectedly from the wand | <p>Is the "Power" LED (green) on the main display flashing?</p> <ul style="list-style-type: none"> ▶ The "Anti freezing (dynamic mode)" is set to "ON". (Water comes out from near the wand and from the bowl unit at about 5 minute intervals.) (→Pages 37, 52) <hr/> <p>When you sit on the toilet seat, water comes out for several seconds while water is warmed up.</p> <hr/> <p>Is the Wand CLEAN LED flashing?</p> <ul style="list-style-type: none"> ▶ "Auto wand CLEAN" starts and the wand is cleaned. (→Page 18) |

Warm air drying

| Trouble | Please check |
|-------------------------------------|---|
| The dryer temperature is low | Is the dryer temperature set to low level? (→Page 22) |
| Stops in the middle of use | <p>The feature stops automatically after about 10 minutes of continuous use.</p> <hr/> <p>Does the seat switch have difficulty detecting?</p> <ul style="list-style-type: none"> ▶ Sit back on the toilet seat. If you get up slightly from the seat, or sit forward on the seat, the seating switch may temporarily stop detecting your presence. (→Page 9) |

Flushing

| Trouble | Please check |
|---|---|
| For not flushing | <p>Is the shutoff valve fully open? (→Page 15)</p> <hr/> <p>Has a power outage occurred?</p> <ul style="list-style-type: none"> ▶ You can use the manual water supply knob (orange) and manual water drainage cord (white) to flush the bowl unit. (→Pages 49, 50) <hr/> <p>Has a water failure occurred?</p> <ul style="list-style-type: none"> ▶ Use a bucket to flush water. (→Page 51) |
| Pressing the flush button (on the top unit or remote control) does not flush the bowl unit | <p>Did you press the button repeatedly?</p> <ul style="list-style-type: none"> ▶ Operation is disabled for about 30 seconds after pressing the flush button. <hr/> <p>Is the LEDs on the main display flashing?</p> <ul style="list-style-type: none"> ▶ The tank is filling with water. It takes about a minute for water supply to complete. (The required time depends on the usage conditions such as the water supply pressure.) |

The bowl unit does not clean automatically or timing is delayed (Auto flushing)

Is "Auto flushing" set to "OFF"?
 ► Set to "ON". (→Page 29)

Even if "Auto flushing" is set to "ON", it is not available in the following instances.

About 60 seconds after the toilet is flushed.

► Wait about 60 seconds and flush the toilet with the remote control. (→Page 20)

When the time spent sitting on the toilet seat or standing in front of the bowl unit is less than about 6 seconds.

► Flush with the remote control. (→Page 20)

When staying in front of the bowl unit after standing and using the toilet.

► Step away from the toilet and wait for about 3 seconds.

When water droplets or dirt are disrupting the body sensor.

► Remove any dirt that is on the body sensor. (→Page 13)

The seat switch will not turn on unless you sit on the seat properly.

► Sit back on the toilet seat. (→Page 9)

The timing for the "Auto flushing" can be changed. (→Page 30)

The toilet flushes on its own

Is "Auto flushing" set to "ON"?
 ► You can turn it "OFF". (→Page 29)

Does the seat switch have difficulty detecting?

► Sit back on the toilet seat. If you get up slightly from the seat, or sit forward on the seat, the seating switch may temporarily stop detecting your presence. (→Page 9)

► Remove any dirt that is on the body sensor. (→Page 13)

Is the "Power" LED (green) on the main display flashing?

► The "Anti freezing (dynamic mode)" is set to "ON". (Water comes out from near the wand and from the bowl unit at about 5 minute intervals.) (→Pages 37, 52)

Waste material does not flush down completely

Is the shutoff valve fully open? (→Page 15)

Is the water supply filter clogged?

► Clean the filter. (→Page 48)

Is the water supply to the toilet disrupted by other running water fixtures?

► Cease using other fixtures and then flush the toilet.

Are the flush and light flush buttons being used correctly? (→Page 20)

► Full flush (for solid waste) : up to 33 ft (10 m) of toilet paper (single).

► Light flush (for liquid waste): up to 10 ft (3 m) of toilet paper (single).

Flushing may be difficult depending the consistency of the waste material.

► Flush the toilet again. If the bowl unit is not cleansed with a flushing, remove the stains with a brush or similar instrument. (→Page 42)

When the tank is filling, you cannot flush the toilet.

► Once the "Power" LED on the main display are lit and the tank fills up with water, flush the toilet.

The volume of water for flushing the bowl unit has changed

The volume of water for flushing the bowl unit may sometimes be adjusted automatically. During this adjustment, the volume of water used for flushing may be different from usual. After adjustment completes, the bowl unit returns to flushing at the normal volume.

A small amount of water flows into the bowl unit after the unit flushes

If the water supply pressure drops significantly, for example if water is used elsewhere or if there is a water failure, water is supplied so that the water surface in the bowl unit rises to a certain level.

If the above symptom reappears

► There may be a malfunction.

Consult with TOTO customer service

(→see contact information on the back cover).

Troubleshooting

Flushing (continue)

| Trouble | Please check |
|---|--|
| Water keeps being supplied to the bowl unit | Did you stop the water supply for flushing in case of power outage? ▶ Turn the manual water supply knob (orange) to stop supplying water. (→Page 50) |
| Some barium remains after flushing | It may be difficult to flush down substances with a higher specific gravity than water, such as barium. ▶ Flush the toilet again. If the bowl unit is not cleansed by flushing, clean it with a cleaning sponge or brush. (→Page 42) |
| There is residue on the bowl unit surface | Oil and other hard-to-see grime may stick to the bowl unit surface. ▶ Clean with (non-abrasive) neutral toilet detergent. (→Page 42) |
| Using the manual water supply knob (orange) and manual water drainage cord (white) doesn't flush the bowl unit. (If the water does not flow due to a power outage) | When using the manual water drainage cord (white) to flush the bowl unit, pull it toward you for 4 seconds or longer. (→Pages 49, 50) Did you turn the manual water supply knob (orange)? ▶ Turn the manual water supply knob (orange) to start supplying water. (→Page 49) The water level may not be sufficient. ▶ Hold the manual water supply knob in the turned position to continue supplying water until the water in the bowl unit returns to the original level. (→Page 50) |

Toilet Seat and Toilet Lid (Auto open/close)

| Trouble | Please check |
|---|--|
| The toilet lid does not open automatically | Is "Auto open/close" set to "OFF"? ▶ Set to "ON". (→Page 32) Does the body sensor have difficulty detecting? ▶ Remove any dirt that is on the body sensor. (→Page 13) Even when set to "ON", "Auto open/close" is not performed for about 15 seconds after the toilet seat or toilet lid is closed. When the toilet lid is closed with the remote control or by hand (To make the product more user-friendly, a time interval is set from when the lid is closed to when it will open next.) ▶ Move away from the toilet and wait at least about 15 seconds before approaching the bowl unit again or open and close by hand. (→Page 20) Detection by the body sensor may be difficult when the room temperature exceeds 86 °F (30 °C). ▶ Use the remote control to open or close it. (→Page 20) Is "Auto open delay" set to [SET 2] or [SET 3]? (→Page 33) The toilet lid does not open automatically for about 10 to 60 seconds after the power is turned ON. ▶ Use the remote control to open or close it. (→Page 20) Is a toilet lid or seat cover installed? ▶ Remove any covers. (→Page 10) |

| | |
|---|--|
| The toilet lid does not close automatically | <p>Is "Auto open/close" set to "OFF"?</p> <p>▶ Set to "ON". (→Page 32)</p> <hr/> <p>If the body sensor detects a person, the toilet lid will not close automatically.</p> <p>▶ The toilet lid will close approximately 90 seconds after the person leaves. (→Pages 16, 17)</p> <hr/> <p>If they do not close automatically even though "Auto open/close" is set to "ON", the body sensor may be detecting incorrectly.</p> <p>▶ If there is a reflective object in front, such as a mirror or glass, move the reflective object or use a curtain or other object to block it. (→Page 9)</p> |
| The toilet lid opens on its own | <p>Is the body sensor directly exposed to sunlight?</p> <p>▶ Do not directly expose the body sensor to sunlight, because it may cause incorrect detection. (→Pages 9, 10)</p> <hr/> <p>Is there a heater within the detection range of the body sensor?</p> <p>▶ Do not place within the detection range of the body sensor. (→Pages 9, 10)</p> <hr/> <p>Is a urinal or wash basin also installed in the bathroom?</p> <p>▶ The sensor may detect someone using the urinal, causing the toilet lid to open or close. (→Pages 9, 10)</p> <hr/> <p>When the bathroom door is open, the sensor may detect people who pass in front of the toilet. (→Page 9)</p> |
| The toilet lid closes on its own | <p>Is "Auto open/close" set to "ON"?</p> <p>▶ You can turn it "OFF". (→Page 32)</p> <hr/> <p>Is "Auto close delay" set to [SET 1]? (→Page 32)</p> <hr/> <p>The seat switch will not turn on unless you sit on the seat properly.</p> <p>▶ Sit back on the toilet seat. (→Page 9)</p> |
| The toilet lid and toilet seat open at the same time | <p>Is "Seat/lid" set to "Seat·lid"? (→Page 33)</p> |
| Stops (or closes) while opening | <p>If the toilet lid or seat hits an obstruction the first time it opens after the power is turned ON, it may stop (or close) partway during the next operation.</p> <p>▶ Eliminate any obstructions and turn the power OFF. Turn the power ON again after about 5 seconds. Then press the "Opening and closing the toilet lid" button on the remote control. (→Page 20)</p> |
| The open timing has changed | <p>Detection by the body sensor may be difficult when the room temperature exceeds about 86 °F (about 30 °C), such as in the summertime. (→Page 9)</p> |
| Cannot open or close with the remote control | <p>If it opens automatically.</p> <p>▶ Check "Is the remote control working?" (→Page 56)</p> <hr/> <p>If automatic opening does not work either</p> <ul style="list-style-type: none"> • The toilet lid may not be mounted correctly. <p>▶ Mount them correctly. (→Page 44)</p> <hr/> <p>Incorrect detection may occur when operating under fluorescent lights.</p> |

Troubleshooting

Toilet Seat and Toilet Lid

| Trouble | Please check |
|---|---|
| <p>The toilet seat is cold</p> | <p>Is the toilet seat temperature set to "OFF" or a low level? (<i>→Pages 22, 23</i>)</p> <hr/> <p>Is energy saver in operation? The energy saver feature is on when the "Energy saver" LED is on and the "Power" LED is off on the main display. When you sit on the seat, the toilet seat heater is turned on temporarily and the seat is warmed in about 15 minutes. (<i>→Pages 26, 27</i>) ► You can turn it "OFF" if the energy saver feature is "ON". (<i>→Pages 28, 29</i>)</p> <hr/> <p>Have you been seated for a long time? After about 20 minutes of sitting, the temperature starts going down, and after about 1 hour, the toilet seat heater is turned "OFF". ► Stand up from the seat and then use again.</p> <hr/> <p>Is a toilet lid or seat cover installed? ► Remove any covers. (<i>→Page 10</i>)</p> |
| <p>The toilet seat and lid close on their own and then the bowl unit flushes</p> | <p>Is "Auto flush lid closed" turned ON? (<i>→Pages 30, 31</i>)</p> |

Auto flush lid closed

| Trouble | Please check |
|--|--|
| "Auto flush lid closed" does not work | <p>Is "Auto flush lid closed" turned OFF? ► Turn it ON. (→Pages 30, 31)</p> <hr/> <p>If "Auto flush lid closed" is turned ON: Check the "Auto flushing" and "Auto open / close" settings. (→Pages 29, 32)</p> <p>Even if "Auto flushing" is turned ON, "Auto flush lid closed" does not activate in the following cases.</p> <p>About 60 seconds after the toilet is flushed. ► Wait about 60 seconds and flush the toilet with the remote control. (→Page 20)</p> <p>When the time spent sitting on the toilet seat or standing in front of the bowl unit is less than about 6 seconds. ► Flush with the remote control. (→Page 20)</p> <p>When staying in front of the bowl unit after standing and using the toilet. ► Step away from the toilet and wait for about 10 seconds.</p> |
| The toilet lid closes too early or too late | <p>You can change "Auto flush delay" to modify the length of time before closing the toilet lid. (SET 1 / SET 2 / SET 3) (→Page 30)</p> |

Energy Saver

| Trouble | Please check |
|---|--|
| The Energy saver LED does not light up | <p>Has the power to the product been turned "OFF" or was there a power outage? The Energy saver LED on the main display may go off when the power is turned ON even if the energy saver feature is ON. It will turn on within about 24 hours since the setting is retained.</p> |
| The timer energy saver feature is not working | <p>Have the batteries in the remote control been replaced? "Timer energy saver" may be canceled when the batteries are replaced. ► Set the timer energy saver again at the time you want to start it. (→Page 29)</p> |
| The auto energy saver+ or auto energy saver feature is not working | <p>Because this function takes several days learning the usage conditions before starting energy saver, the amount of energy saving may be low, depending on the frequency of use. ► Check the energy saver setting. (→Pages 26, 27)</p> |

Troubleshooting

Deodorizer

| Trouble | Please check |
|---|---|
| The deodorizer seems to be not working | <p>Is "Deodorizer" set to "OFF"?</p> <p>▶ Set to "ON". (→Page 35)</p> <hr/> <p>Even after sitting down, you do not hear operation sounds.</p> <p>▶ Sit back on the toilet seat.</p> <p>If you hear an operation sound from the deodorizer, but odors are not removed.</p> <p>▶ Clean the deodorizing filter. (→Page 46)</p> |
| A strange odour is emitted | <p>Are you using an air freshener or deodorizer that you purchased separately?</p> <p>Doing so may reduce the effectiveness of the product's deodorizer or cause strange odours.</p> <p>▶ Remove the air freshener or deodorizer.</p> |
| The auto power deodorizer feature is not working | <p>Is "Auto power deodorizer" set to "OFF"?</p> <p>▶ Set to "ON". (→Page 35)</p> <hr/> <p>The auto power deodorizer starts about 10 seconds after you stand up from the toilet seat.</p> |

Lights

| Trouble | Please check |
|--|---|
| The soft light does not light up | <p>Is "Soft light" turned OFF?</p> <p>▶ Set to "ON". (→Page 36)</p> |
| The soft light lights permanently | <p>Is "Night light" ("Night mode") turned ON?</p> <p>▶ If it is turned ON, the Soft light lights permanently. You can also turn it OFF [STANDBY]. (→Pages 36, 37)</p> |

Others

| Trouble | Please check |
|---|--|
| Water is leaking from the plumbing connections | <p>If any nuts in a connection are loose, firmly tighten them with a tool such as a monkey wrench.</p> <p>▶ If the water leak does not stop, close the shutoff valve and consult with TOTO customer service. (→see contact information on the back cover)</p> |
| The top unit is unstable | <p>There is clearance between the toilet seat cushion and the bowl unit for activating the seat switch.</p> <p>▶ When you sit on the toilet seat, the toilet seat subsides slightly to activate the seat switch. (→Page 9)</p> |
| Water splashes up when using the toilet | <p>The water in the bowl unit that is used to mask the smell of excrement is the cause of the splashing.</p> <p>▶ Adding a layer of toilet paper on the surface of the water can slightly dampen splashing.</p> |
| When flushing, you hear a squishy sound underneath the floor | <p>There are cases when the sound is made inside the discharge pipe because of the device to ensure water in the bowl unit after the unit flushes.</p> |
| When flushing, you hear a gurgling sound | <p>When the toilet is flushed together with waste material, the sound is a result of air, waste material and water being pulled through the system.</p> |
| Water flows to the bowl unit after it finishes flushing | <p>Is water used for anything other than the toilet?</p> <p>▶ Stop water elsewhere before flushing the bowl unit.</p> |
| There are black stain on or around the bowl unit | <p>Ammonia in urine may cause black stains.</p> <p>▶ If urine has splashed on the bowl unit or floor, wipe it immediately.</p> |
| The top unit makes a sound | <p>When sitting on the toilet seat</p> <p>If "Pre-mist" is "ON", you may hear pre-mist spraying in the bowl unit to make it more difficult for dirt to adhere.</p> <p>▶ You can turn it "OFF". (→Page 34)</p> <hr/> <p>When moving away from the bowl unit after use</p> <p>When "Auto power deodorizer" is "ON", operation sounds are made while the deodorizing power increases for 60 seconds after you stand up from the toilet seat.</p> <p>▶ You can turn it "OFF". (→Page 35)</p> <p>If "Auto wand CLEAN" is "ON" and you use the washing functions (e.g.,Rear washing and Front washing), you may hear that the wand is extended and cleaned with "EWATER+".</p> <p>▶ You can turn it "OFF". (→Page 34)</p> <p>You may hear that the wand is extended and the remaining water in the product is drained after "Auto wand CLEAN" and other functions are performed.</p> |

Troubleshooting

Others (continue)

| Trouble | Please check |
|--|---|
| The top unit makes a sound | <p>When not using the product (e.g., at night) If "Auto wand CLEAN" is "ON" and you do not use the washing functions (e.g., Rear washing and Front washing) for about 8 hours, you will hear that the wand is cleaned with "EWATER+" and then the remaining water is drained from inside the product. ► You can turn it "OFF". (→Page 34)</p> <p>Operating noise may occur for extending the wand to prevent damage due to freezing by discharging the water remaining within the product.</p> |
| You feel air in the bowl unit when sitting on the toilet seat | <p>A mist is sprayed inside the bowl unit to make it more difficult for dirt to adhere when sitting on the toilet seat. You may feel air when a mist is sprayed. ► You can turn it "OFF". (→Page 34)</p> |
| There is black or pink slime on the bowl unit surface | <p>It is a result of growth of airborne fungal spores or bacteria that feed on filth on the bowl unit. ► Clean with (non-abrasive) neutral toilet detergent.</p> |
| There are water droplets on the bowl unit surface | <p>Condensation occurs when the humidity is high, and there is a significant difference between water and room temperatures. ► Wipe off droplets with dry cloth. (Condensation can build up on condensation-proof bowls when the difference between room and water temperatures exceeds 59 °F (15 °C) and the ambient humidity reaches 80 %.)</p> |
| It takes a long time for the tank to fill | <p>Is the shutoff valve fully open? (→Page 15)</p> <p>Is the water supply filter or drain plug with water supply filter clogged? ► Clean the filter. (→Pages 47, 48)</p> |
| The water supply hose makes a hissing sound during and after flushing | <p>The next time you flush the toilet, you will hear the sound of water being supplied to the toilet and tank. If the noise is loud, the water supply pressure may be high. ► Slightly turn the water shutoff valve to the right until the sound stops.</p> |
| After the bowl unit is flushed, a bang is heard | <p>Water hammer has occurred in the pipes while the water is supplied or stopped. ► Tighten the shutoff valve to reduce the water rate to an extent that does not affect a practical use of the toilet.</p> |
| The top unit cannot be operated through the remote control | <p>Follow the instructions "Please check first (A–C)". (→Page 56)</p> <p>The following conditions may affect the reception performance of the remote control, resulting in not being able to operate the top unit.</p> <ul style="list-style-type: none"> • When the room size, the layout of fixtures etc. interfere • When the color of the ceiling or walls is too dark, or their shape or material interfere • When there is a rack or cabinet installed on the wall behind the top unit • When an inverter lighting system is used <p>► Change the position of the remote control and try again.</p> |

Specifications

| Item | G5A |
|------------------------------------|---|
| Rated power supply | AC 120 V 60 Hz |
| Rated power consumption | 1276 W |
| Maximum power consumption | 1432 W |
| Type of water heater | Instantaneous type |
| Power cord length | 3.9 ft (1.2 m) |
| Water protection level | IPX4 |
| Bowl unit | |
| Flush volume ^{*1} | Full 1.2 gal (4.5 L), Light 1.0 gal (3.8 L) |
| Water supply system | Direct supply, with concealed tank system |
| Flush type | TORNADO FLUSH |
| Bowl style | Elongated |
| Anti freezing | |
| Dynamic mode | Flush volume (dynamic) ^{*2} : 10 gal/h (39 L/h) |
| Top unit | |
| Washing | |
| Spray volume ^{*3} | Rear washing: Approx. 0.07-0.11 gal/min (Approx. 0.27-0.43 L/min) Rear soft washing: Approx. 0.07-0.11 gal/min (Approx. 0.27-0.43 L/min) Front washing: Approx. 0.08-0.11 gal/min (Approx. 0.29-0.43 L/min) |
| Water temperature | Adjustable temperature range: OFF, about 95-104 °F (about 35-40 °C) |
| Heater capacity | 1116 W |
| Safety device | Temperature fuse |
| Backflow prevention device | Vacuum breaker, Check valve |
| Heated seat | |
| Surface temperature | Adjustable temperature range: OFF, about 82-97 °F (about 28-36 °C) <Auto energy saver: about 79 °F (about 26 °C) Auto energy saver+: OFF> |
| Heater capacity | 50 W |
| Safety device | Temperature fuse |
| Deodorizer | |
| Method | O ₂ deodorization |
| Airflow volume | Normal mode: Approx. 3.18 ft ³ /min (Approx. 0.09 m ³ /min) Power mode: Approx. 5.65 ft ³ /min (Approx. 0.16 m ³ /min) |
| Power consumption | Normal mode: Approx. 1.6 W, Power mode: Approx. 4.0 W |
| Warm air dryer | |
| Warm air temperature ^{*4} | Adjustable temperature range: about 95-140 °F (about 35-60 °C) |
| Airflow volume | Approx. 8.83 ft ³ /min (Approx. 0.25 m ³ /min) |
| Heater capacity | 238 W |
| Safety device | Temperature fuse |
| Water supply pressure | Minimum required water pressure: 7.25 PSI (0.05 MPa) <Dynamic, 2.6 gal/min (10 L/min)>, Maximum water pressure: 108.75 PSI (0.75 MPa) <Static> |
| Water supply temperature | 32-95 °F (0-35 °C) |
| Working ambient temperature | 32-104 °F (0-40 °C) |
| Dimensions | W 1.27 x D 2.37 x H 1.87 ft (W 386 x D 722 x H 569 mm) |
| Weight | About 99 lb (about 45 kg) <Top unit about 14 lb (about 6 kg), Bowl unit about 85 lb (about 38 kg)> |

When disposing of this product, please follow your local or state guidelines for proper disposal.

*1 Measured value based on ASME A112.19.2/CSA B45.1.

*2 The flush volume changes depending on water pressure.

*3 At 29 PSI (0.20 MPa) (dynamic) water pressure

*4 Temperature around the warm air outlet measured by TOTO.

Limited Warranty

One Year Limited Warranty

1. TOTO warrants its product to be free from defects in materials and workmanship during normal use when properly installed and serviced, for a period of one (1) year from date of purchase. This limited warranty is extended only to the ORIGINAL PURCHASER of the Product and is not transferable to any third party, including but not limited to any subsequent purchaser or owner of the Product. This warranty applies only to TOTO Product is purchased and installed in USA and Canada.
2. TOTO's obligations under this warranty are limited to repair, replacement or other appropriate adjustment, at TOTO's option, of the Product or parts found to be defective in normal use, provided that such Product was properly installed, used and serviced in accordance with instructions.
TOTO reserves the right to make such inspections as may be necessary in order to determine the cause of the defect. TOTO will not charge for labor or parts in connection with warranty repairs or replacements. TOTO is not responsible for the cost of removal, return and/or reinstallation of the Product.
3. This warranty does not apply to the following items:
 - a) Damage or loss sustained in a natural calamity such as fire, earthquake, flood, thunder, electrical storm, etc.
 - b) Damage or loss resulting from any accident, unreasonable use, misuse, abuse, negligence, improper care, or maintenance of the Product.
 - c) Damage or loss resulting from sediments or foreign matter contained in a water system.
 - d) Damage or loss resulting from the quality of water in the region where the product is used.
 - e) Damage or loss resulting from improper installation or from installation of the Product in a harsh and/or hazardous environment, or improper removal, repair or modification of the Product. This includes locations where the water pressure is above local codes or standards. (NOTE : Product model codes allow a maximum of 80 PSI. Check local codes or standards for requirements).
 - f) Damage or loss resulting from electrical surges or lightning strikes or other acts which are not the fault of TOTO or which the Product is not specified to tolerate, including failure to use the factory equipped cord and plug or use of a loose or faulty electrical outlet or use of a current or socket other than a 120 V, 60 Hz electrical current from a GFI (ground, fused) socket.
 - g) Damage or loss resulting from normal and customary wear and tear, such as gloss reduction, scratching or fading over time due to use, cleaning practices or water or atmospheric conditions, including but not limited to, the use of bleach, alkali, acid cleaners, dry (powder) cleaners or any other abrasive cleaners or the use of metal or nylon scrubbers.
4. If the Danger Label which has been placed over the seams on the back of the product's top unit is broken or otherwise not intact, this limited warranty is void.
5. In order for this limited warranty to be valid, proof of purchase is required. TOTO encourages warranty registration upon purchase to create a record of Product ownership at <http://www.totousa.com>. Product registration is completely voluntary and failure to register will not diminish your limited warranty rights.
6. If the Product is used commercially or is installed outside of USA or Canada. TOTO warrants the Product to be free from defects in materials and workmanship during normal use for one (1) year from the date of installation of the Product, and all other terms of this warranty shall be applicable except the duration of the warranty.
7. This warranty gives you specific legal rights. You may have other rights which vary from state to state, province to province or country to country.
8. To obtain warranty repair service under this warranty, you must take the Product or deliver it prepaid to a TOTO service facility together with proof of purchase (original sales receipt) and a letter stating the problem, or contact a TOTO distributor or products service contractor, or write directly to TOTO U.S.A., INC., 1155 Southern Road, Morrow, GA 30260 (888) 295 - 8134 or (678) 466-1300, if outside the U.S.A. If, because of the size of the Product or nature of the defect, the Product cannot be returned to TOTO, receipt by TOTO of written notice of the defect together with proof of purchase (original sales receipt) shall constitute delivery. In such case, TOTO may choose to repair the Product at the purchase's location or pay to transport the Product to a service facility.

WARNING! TOTO shall not be responsible or liable for any failure of, or damage to, this Product caused by either chloramines in the treatment of public water supply or cleaners containing chlorine (calcium hypochlorite).

NOTE: The use of a high concentrate chlorine or chlorine related product's can seriously damage the fittings. This damage can cause leakage and serious property damage.

THIS WRITTEN WARRANTY IS THE ONLY WARRANTY MADE BY TOTO. REPAIR, REPLACEMENT OR OTHER APPROPRIATE ADJUSTMENT AS PROVIDED UNDER THIS WARRANTY SHALL BE THE EXCLUSIVE REMEDY AVAILABLE TO THE ORIGINAL PURCHASER. TOTO SHALL NOT BE RESPONSIBLE FOR LOSS OF THE PRODUCT OR FOR OTHER INCIDENTAL, SPECIAL OR CONSEQUENTIAL DAMAGES OR EXPENSES INCURRED BY THE ORIGINAL PURCHASER, OR FOR LABOR OR OTHER COSTS DUE TO INSTALLATION OR REMOVAL, OR COSTS OF REPAIRS BY OTHERS, OR FOR ANY OTHER EXPENSE NOT SPECIFICALLY STATED ABOVE. IN NO EVENT WILL TOTO'S RESPONSIBILITY EXCEED THE PURCHASE PRICE OF THE PRODUCT. EXCEPT TO THE EXTENT PROHIBITED BY APPLICABLE LAW, ANY IMPLIED WARRANTIES, INCLUDING THAT OF MERCHANTABILITY OR FITNESS FOR USE OR FOR A PARTICULAR PURPOSE, ARE EXPRESSLY DISCLAIMED. SOME STATES DO NOT ALLOW LIMITATIONS ON HOW LONG AN IMPLIED WARRANTY LASTS, OR THE EXCLUSION OR LIMITATION OF INCIDENTAL OR CONSEQUENTIAL DAMAGES, SO THE ABOVE LIMITATION AND EXCLUSION MAY NOT APPLY TO YOU.

MEMO

MEMO

MEMO

TOTO

TOTO U.S.A., Inc. 1155 Southern Road Morrow, GA 30260
Phone : (770) 282-8686

Warranty Registration and Inquiry

For product warranty registration, TOTO U.S.A. Inc. recommends On-Line Warranty Registration. Please visit our web site <http://www.totousa.com>. If you have questions regarding warranty policy or coverage, please contact TOTO U.S.A. Inc., Customer Service Department, 1155 Southern Road, Morrow, GA 30260 (888) 295 - 8134 or (678) 466 - 1300 when calling from outside of U.S.A.

- You are advised to record the following information to allow quick service.

| | |
|-----------------------|----------------|
| Date of purchase : | Name of shop : |
| Date : year month day | Tel : () |



This code is for manufacturer management use.

2023.12.22
D07J43