



PIPE TOOLS & VISES
SINCE 1896

Mechanical Hot Tapping Machine - DM3MECH

Replacement Parts

Parts List

Ref. No.	Description	Item Code	DM3MECH	DM3MECHB
			08530	08531
Qty. Used			Qty. Used	Qty. Used
1	24" Shaft Complete	93514	1	1
2	Gland Nut	93501	1	1
3	Brass Ring	93502	1	1
4	3/16" Graphite	43511	1	1
5	Main Body	93500	1	1
6	18" Shaft	93515	1	1
7	Arbor	43508	1	-
8	Split Coupon Retainer	93506	1	1
9	Drill Bit	43507	1	1
10	1/8" Allen Wrench	40286	1	1
11	5/32" Allen Wrench	40149	1	1
12	5/8" Hole Saw	43500	1	-
13	7/8" Hole Saw	43501	1	-
14	1-1/8" Hole Saw	43502	1	-
15	1-3/8" Hole Saw	43503	1	-
16	1-3/4" Hole Saw	43504	1	-
17	2-1/4" Hole Saw	43505	1	-
18	Tool Box	93526	1	1
19	3-1/4" Hole Saw	43506	1	-
20	Body Protector	43510	1	1
21	5/16 Set Screw	33524	2	2
22	O - Ring	43513	1	1
23	1/4 Set Screw	30018	1	1
24	Main Assembly	93527	-	-

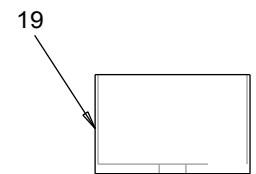
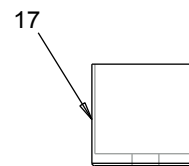
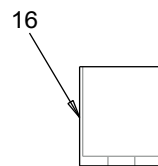
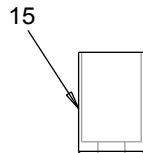
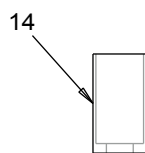
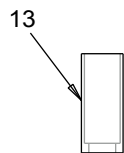
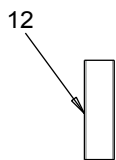
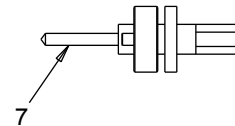
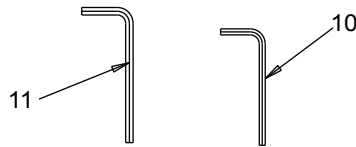
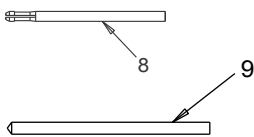
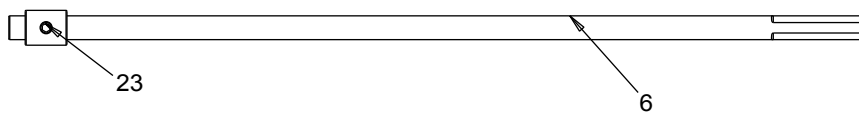
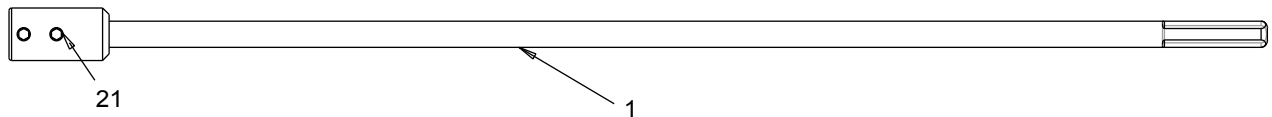
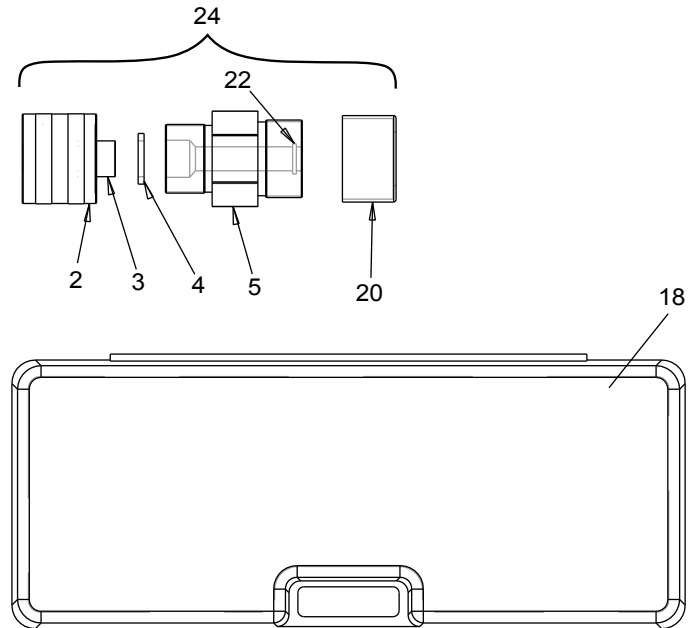

Reed Manufacturing Company
1425 West 8th Street
Erie, PA 16502 USA

QUALITY
& Service
that Last a Lifetime

Phone: 800-666-3691 or 814-452-3691
Fax: 800-456-1697 or 814-455-1697
www.reedmfgco.com

RP-911-90
See also: 58350